

iTero Element™ 2 iTero Element™ Flex iTero Element™ 2 Plus

intraoral scanners

User manual



it starts with **iTero™**

Copyright

© 2022 Align Technology, Inc. All rights reserved.

The information contained in this manual is subject to change without notice.

The hardware and software described in this manual are supplied under a Sales and Services Agreement and may be used only in accordance with the terms of that agreement.

No part of this manual may be reproduced, photocopied, stored in a retrieval system, or transmitted in any manner (electronic or mechanical) for any purpose other than the customer's normal usage, without the prior written permission of Align Technology.

English language version

PN 218501 Rev. A
Updated November 2022

Patents

www.aligntech.com/patents

Trademarks

Align, Invisalign, ClinCheck and iTero among others, are trademarks and/or service marks of Align Technology, Inc. or one of its subsidiaries or affiliated companies and may be registered in the U.S. and/or other countries.

Any other trademarks or registered trademarks appearing in this manual are the property of their respective owners.

Global headquarters

Align Technology, Inc.

410 North Scottsdale Road,
Suite 1300, Tempe,
Arizona 85281,
USA

www.aligntech.com

Tel: +1 (408) 470-1000
Fax: +1 (408) 470-1010

Customer Support

Tel: +1 (800) 577-8767
E-mail: iterosupport@aligntech.com



Align Technology Ltd.

1 Yitzhak Rabin Rd.,
Petach Tikva, 4925110,
Israel

Tel: +972 (3) 634-1441
Fax: +972 (3) 634-1440



Align Technology B.V.

Herikerbergweg 312
1101 CT, Amsterdam
The Netherlands

Contraindications

For persons who have been diagnosed with Epilepsy, there is a risk of epileptic shock from the flashing light of the iTerо scanner. These persons should refrain from any eye contact with the flashing light associated with the system during operation.

Compliance

Class 1 laser compliance

This device complies with 21 CFR 1040.10 and IEC 60825-1.



CSA compliance

This device complies with the following CSA standard for Canada and the USA: UL Std No. 60601-1 – Medical Electrical Equipment Part 1: General Requirements for Safety.



FCC compliance

This device complies with Part 15 of FCC Rules and its operation is subject to the following two conditions:

1. This device may not cause harmful interference.
2. This device must accept any interference received, including interference that may cause undesired operation.



FCC warning

Modifications to the device that are not expressly approved by the manufacturer may void your authority to operate the device under FCC Rules.

Safety compliance

This device complies with the following safety standard:

IEC 60601-1 Medical electrical equipment - Part 1: General requirements for basic safety and essential performance.

EMC compliance

This device complies with the following EMC standard:

IEC 60601-1-2 Medical electrical equipment - Part 1-2: General requirements for basic safety and essential performance - Collateral standard: Electromagnetic phenomena - Requirements and tests.

ANATEL compliance

This device complies with ANATEL resolution nº 242/2000 under the number ANATEL 02563-15-06534.

CE compliance

This device complies with Council Regulations (EU) 2017/745 for Medical Devices.



Nature of emitted scanner radiation

- **Electromagnetic radiation (EMR)** - When used as directed, the iTero scanner's level of electromagnetic radiation is similar to that of a personal computer and complies with International Standard IEC 60601-1-2.
- **Laser and LED radiation** - When used as directed, the iTero scanner's level of Laser and LED radiation is incapable of producing damage to eyes or other human tissue and complies with International standards IEC 62471 and IEC 60825-1.

Symbols

The following symbols may appear on iTero Element 2 and iTero Element 2 Plus hardware components and may appear within this document and other iTero Element literature.



Follow instructions for use.



Type BF applied part.



Separate collection of electrical waste and electronic equipment is required. In compliance with the European Directive on Waste Electrical and Electronic Equipment (WEEE), do not dispose of this product in domestic or municipal waste. This device contains WEEE materials.

Please contact the EARN service.

Link for the online request form: <http://b2btool.earn-service.com/aligntech/select>



Caution - Wherever this symbol appears on the device, it is mandatory to refer to safety-related information in this document.



Do not re-use.

"Rx only"

CAUTION: US Federal Law restricts this device to sale by or on the order of a licensed Dentist, Orthodontist, or Dental Professional. The system serves as a prescription medical device and should be operated by qualified health-care providers only.



Medical device manufacturer.



Catalogue number.



Serial number.



Alternating current.



Keep dry.



Temperature limit.



Batch code.



Atmospheric pressure limitation.



Humidity limitation.



Fragile, handle with care.



This side should be up.



IEC 60417-5031: Direct current.



Wand (scanning unit).



Unique device identifier.



Country of manufacture (including date of manufacture).



Medical device.



Consult the electronic instructions for use.



USB socket.



Electric battery.



IEC 60417-5009: STAND-BY.



Stepping prohibited.



Authorized representative in the European Community.



RoHS compliant for China.



CE mark.

Safety instructions

Before beginning to work with the system, all users are required to read these safety instructions.

Power supply

Power is supplied to the system via a medical-grade power supply. In iTero Element 2 Plus cart-configuration scanners, the power supply is enclosed in the base of the wheel stand. In iTero Element 2 Plus mobile-configuration scanners, the power supply is external.

Battery power

- Charging – the scanner battery will be fully charged after being plugged into a power source for 2 hours (iTero Element 2) or 2.5 hours (iTero Element 2 Plus).
- With a fully-charged battery, you can scan for up to 30 minutes using the wheel-stand or cart-configuration scanner, or 10 minutes using the mobile-configuration scanner.

Warning: The cart-configuration scanners are provided with two Li-ion rechargeable battery packs and the wheel-stand configuration and mobile-configuration scanners are provided with one battery pack. There is a danger of battery explosion if the screen is damaged. Do not use the scanner if dropped or any damage is noticed. Contact Customer Support.

- Use only the original AC/DC adaptor connected to the system to charge the batteries.
- **Warning:** A failing Li-ion battery begins to hiss, bulge, and leak electrolytes. The electrolytes consist of lithium salt in an organic solvent (lithium hexafluorophosphate), which is highly flammable. Burning electrolytes can ignite combustible materials in close proximity.

Please note, there is a risk of burns associated with this situation.

- The screen should be stored and operated following the environmental conditions that appear in this manual. Do not expose the scanner to extreme heat sources, such as radiators and fireplaces.
- Never operate the device without batteries! Do not use the batteries for any purpose other than the intended use of the product. Discard used batteries according to the manufacturer's instructions and local requirements.
- Replace the batteries only with the same battery type supplied by Align.

Electric warnings

- Do not remove external panels and covers in order to avoid electrical shock. There are no user-serviceable parts inside. In iTero Element 2 Plus scanners, you can open the cover of the diagnostics panel in case of system failure, only when required by Customer Support.
- Do not connect the scanner to a mains supply without protective grounding, in order to avoid the risk of electrical shock.

iTero Element Flex:

- The iTero Element Flex scanner is provided with a hub containing the power supply for the wand. Do not place the system on a wet surface or step on it, in order to avoid the risk of system damage and electrical shock.
- Never connect the hub to a laptop that is not approved according to IEC 60950-1 or IEC 62368-1, as applicable. The laptop and all its accessories should be located at least 1.5m away from the patient. Do not scan a patient and touch the laptop or any of its accessories at the same time. Not following these instructions may lead to electrical shock.

Electric precautions

- Do not connect a non-Align-approved web camera to the USB sockets on the rear of the touch screen, in order to avoid the risk of electrical shock.
- Do not connect anything besides the iTero wand to the USB sockets on the hub.
- Do not connect a power cable that is not supplied by Align Technology to the system, in order to avoid electrical shock.

Wireless LAN

- The system comes equipped with a wireless LAN unit.
- When using the product, maintain a separation distance of at least 20cm between the computing unit and all persons' bodies to ensure compliance with RF exposure requirements.

Safety classifications

- Type of protection against electrical shock: Class 1.
- Degree of protection against electrical shock: Type BF.
- Degree of protection against harmful ingress of water: Ordinary.
- Equipment not suitable for use in the presence of flammable anesthetic mixtures.
- Mode of operation: Continuous.

Prescription health device

The system serves as a prescription medical device and should be operated by qualified health-care providers only.

Scanner precautions

- The wand emits red laser light (680nm Class 1) as well as white LED emissions. Normal usage of the wand does not present any danger to the human eye. Avoid shining the wand directly into the patient's eyes.
- Avoid twisting, knotting, pulling, and stepping on the wand cable and the power cable.
- When the system is not in use, the wand should be placed in the cradle with the optical surface facing the cradle, in order to avoid eye contact with the laser beam or the flickering white LED emission. Eye contact could cause damage to the eyes.
- Avoid activating the wand while the tip of the wand is outside the patient's mouth, in order to prevent eye damage.
- Avoid placing the wand in the cradle while the scanning operation is still active, in order to prevent eye damage.
- Do not use the equipment if a scanner malfunction occurs or if physical damage is observed, in order to avoid electrical shock or physical injury. Call Customer Support.

Cleaning & disinfection

To avoid cross-contamination, it is mandatory to:

- Clean and disinfect the wand, as described in [Cleaning and disinfecting the wand](#), and replace the wand sleeve, as described in [Applying a wand sleeve](#), before each patient session.
- Remove and replace gloves after each patient session.
- Discard torn, contaminated, or removed gloves.
- Replace the wand sleeve between each patient. Failing to replace the wand sleeve between patients may cause the inadvertent transfer of microorganisms and other contaminants from one patient to another.
- Dispose of wand sleeves according to standard operating procedures or local regulations for the disposal of contaminated medical waste.

Unpacking & installing

The system should be unpacked and installed following Align Technology's instructions, described in [Assembly instructions](#).

Note: Contact Customer Support if the scanner box is damaged or if the ShockDot indicator on the box has been activated.

Work environment

- The system should be moved between rooms with utmost care to avoid damage.
- Do not block the air vents on the wand and the computing unit.
- The system is intended for indoor use only. It should not be exposed to direct sunlight, excessive heat, or humidity.
- iTero Element Flex only: If the system has just been brought into the office from a hot, cold, or humid environment, it should be set aside until it has adjusted to room temperature, to avoid internal condensation.

Electromagnetic interference precaution

This device has been tested and found to comply with the requirements for medical devices according to standard IEC60601-1-2. This standard is designed to provide reasonable protection against harmful interference in a typical medical installation.

Avoid placing this device near frequency transmitting equipment or other sources of electrical and electromagnetic interference (e.g. cellular phones, mobile two-way radios, electrical appliances, RFID). High levels of such interference, due to close proximity or strength of the source, may result in disruption of performance of this device. In this case, the device can be returned to operation mode after user intervention or by auto-recovery.

General**Notes:**

- Do not make any modifications to this equipment.
- Do not remove the computing unit from the stand after assembly.

Incident notification

Any serious incidents in relation to the iTero device should be reported to Align Technology Ltd. and the competent authority of the Member State in which the user and patient are established.



Contre-indications – French

Pour les personnes ayant un diagnostic d'épilepsie, la lumière clignotante du scanner iTero peut engendrer un risque de choc épileptique. Ces personnes doivent éviter tout contact visuel avec la lumière clignotante inhérente au système pendant le fonctionnement.

Conformité – French

Conformité du laser de classe 1

Cet appareil est conforme aux normes 21 CFR 1040.10 et IEC 60825-1.



Conformité CSA

Cet appareil est conforme à la norme CSA suivante pour le Canada et les États-Unis : UL Std No. 60601-1 - Appareils électromédicaux - Section 1 : Règles générales de sécurité.



Conformité FCC

Cet équipement est conforme à la section 15 des règles la FCC. Son fonctionnement est soumis aux deux conditions suivantes :

1. Cet appareil ne doit causer aucune interférence nuisible.
2. Cet appareil doit accepter toute interférence reçue, y compris des interférences pouvant provoquer un fonctionnement non désiré.



Avertissement de la FCC

Les modifications apportées à l'appareil qui ne sont pas expressément approuvées par le fabricant peuvent révoquer votre droit d'utiliser l'appareil en vertu des règles de la FCC.

Conformité aux normes de sécurité

Cet appareil est conforme à la norme de sécurité suivante :

IEC 60601-1 Appareils électromédicaux - Section 1 : Exigences générales pour la sécurité de base et les performances essentielles.

Conformité CEM

Cet appareil est conforme à la norme CEM suivante :

IEC 60601-1-2 Appareils électromédicaux - Section 1-2 : Exigences générales pour la sécurité de base et les performances essentielles - Norme collatérale : phénomènes électromagnétiques - Exigences et essais.

Conformité ANATEL

Cet appareil est conforme à la résolution ANATEL n° 242/2000 sous le numéro ANATEL 02563-15-06534.

Conformité CE

Cet appareil est conforme aux règlements du Conseil (UE) 2017/745 pour les dispositifs médicaux.



Nature du rayonnement émis par le scanner – French

- **Rayonnement électromagnétique (EMR)** - Lorsqu'il est utilisé conformément aux instructions, le niveau de rayonnement électromagnétique du scanner iTerO est similaire à celui d'un ordinateur personnel et est conforme à la norme internationale IEC 60601-1-2.
- **Rayonnement laser et LED** - Lorsqu'il est utilisé conformément aux instructions, le niveau de rayonnement laser et LED du scanner iTerO est incapable de causer des dommages aux yeux ou à d'autres tissus humains et est conforme aux normes internationales IEC 62471 et IEC 60825-1.

Symboles – French

Les symboles suivants peuvent apparaître sur les composants électroniques iTerO Element 2 et iTerO Element 2 Plus peuvent apparaître dans ce document et dans d'autres documents iTerO Element.



Suivre le mode d'emploi.



Pièce appliquée de BF.



Une collecte séparée des déchets électriques et des équipements électroniques est requise. Conformément à la directive européenne sur les déchets d'équipements électriques et électroniques (DEEE), ne jetez pas ce produit avec les déchets ménagers ou urbains. Cet appareil contient des matériaux DEEE.

Veuillez contacter le service EARN.

Lien vers le formulaire de demande en ligne :
<http://b2btool.earn-service.com/aligntech/select>



Attention Partout où ce symbole apparaît sur l'appareil, il est obligatoire de se référer aux informations relatives à la sécurité contenues dans ce document.



Ne pas réutiliser.

"Rx only"

ATTENTION : La loi fédérale américaine limite la vente de cet appareil par ou pour le compte d'un dentiste, d'un orthodontiste ou d'un professionnel dentaire agréé. Le système constitue un dispositif médical sur ordonnance et ne doit être manipulé que par des professionnels de santé qualifiés.



Fabricant du dispositif médical.



Référence catalogue.



Numéro de série.



Courant alternatif.



Conserver au sec.



Code du lot



Limite de pression atmosphérique



Limite d'humidité



Fragile, à manipuler avec soin.



Ce côté doit être placé vers le haut.



IEC 60417-5031 : Courant continu.



Tige (unité de numérisation).



Identifiant unique de l'appareil



Pays de fabrication (y compris la date de fabrication).



Limite de température.



Dispositif médical.



Consultez les instructions d'utilisation électroniques.



Prise USB.



Batterie électrique.



IEC 60417-5009 : EN ATTENTE.



Montée interdite.



Représentant autorisé dans la Communauté Européenne.



Conforme RoHS pour la Chine.



Marquage CE.

Consignes de sécurité – French

Avant de commencer à travailler avec le système, tous les utilisateurs doivent prendre connaissance de ces consignes de sécurité.

Alimentation électrique

Le système est alimenté via une batterie interne de qualité médicale. Dans iTero Element 2 Plus les scanners de configuration de chariot, l'alimentation électrique est placée dans la base du support de roue. Dans les scanners de configuration mobile, l'alimentation électrique est externe.

Puissance de la batterie

- Charge - la batterie du scanner sera complètement chargée après avoir été branchée à une source d'alimentation pendant 2 h (iTero Element 2) ou 2.5 h (iTero Element 2 Plus).
- Avec une batterie complètement chargée, vous pouvez numériser jusqu'à 30 minutes à l'aide du scanner de configuration desupport de roue ou 10 minutes à l'aide du scanner de configuration mobile.

Avertissement: Les scanners de la configuration chariot sont fournis avec deux packs de batteries rechargeables Li-ion et les scanners de configuration mobiles sont fournis avec un pack de batteries. Il existe un risque d'explosion de la batterie si l'écran est endommagé. N'utilisez pas le scanner en cas de chute ou si des dommages sont constatés. Contactez le service clients.

- Utilisez uniquement l'adaptateur CA/CC d'origine connecté au système pour charger les batteries.
- **Avertissement:** Une batterie Li-ion défaillante commence à siffler, à gonfler et à laisser fuir des électrolytes. Les électrolytes sont constitués de sel de lithium dans un solvant organique (hexafluorophosphate de lithium), qui est très inflammable. La combustion d'électrolytes peut enflammer des matériaux combustibles à proximité immédiate.

Attention, il y a un risque de brûlure associé à cette situation.

- L'écran doit être stocké et utilisé conformément aux conditions environnementales indiquées dans ce manuel. N'exposez pas le scanner à des sources de chaleur extrêmes, telles que des radiateurs et des cheminées.
- N'utilisez jamais l'appareil sans batteries! N'utilisez pas les batteries à des fins autres que l'usage prévu du produit. Jetez les batteries usagées conformément aux instructions du fabricant et aux exigences locales.
- Remplacez les batteries uniquement avec le même type de batterie fournie par Align.

Avertissements électriques

- Ne retirez pas les panneaux ni les couvercles externes afin d'éviter les chocs électriques. L'appareil ne contient aucune pièce remplaçable par l'utilisateur. Pour les scanners iTero Element 2 Plus, vous pouvez ouvrir le capot du panneau de diagnostic en cas de défaillance du système uniquement lorsque le service clients le demande.
- Ne connectez pas le scanner à une alimentation principale sans prise de terre, afin d'éviter tout risque d'électrocution.

iTero Element Flex:

- Le iTero Element Flex scanner est fourni avec un hub contenant l'alimentation de la tige. Ne placez pas le système sur une surface mouillée et ne marchez pas dessus, afin d'éviter tout risque d'endommagement du système et d'électrocution.
 - Ne connectez jamais le concentrateur à un ordinateur portable qui n'est pas approuvé selon CEI 60950-1 ou CEI 62368-1, selon le cas. L'ordinateur portable et tous ses accessoires doivent être situés à au moins 1,5 m du patient. Ne numérisez pas un patient en même temps que vous touchez l'ordinateur portable ou l'un de ses accessoires. Le non-respect de ces instructions peut entraîner un choc électrique.
- Précautions électriques**
- Ne connectez pas une webcam non approuvée par Align aux prises USB à l'arrière de l'écran tactile, afin d'éviter tout risque de choc électrique.
 - Ne connectez rien d'autre que la tige iTero aux prises USB du hub.
 - Ne connectez pas de câble d'alimentation qui n'est pas fourni par Align Technology afin d'éviter tout choc électrique.
- Réseau local sans fil**
- Le système est équipé d'une unité de réseau local sans fil.
 - Lors de l'utilisation du produit, maintenez une distance d'au moins 20 cm entre l'unité de calcul et le corps de toutes les personnes pour garantir la conformité aux exigences d'exposition aux RF.
- Classifications de sécurité**
- Type de protection contre les chocs électriques : Classe 1.
 - Degré de protection contre les chocs électriques : Type BF.
 - Degré de protection contre les infiltrations d'eau dangereuses : Ordinaire.
 - L'équipement ne convient pas à une utilisation en présence de mélanges anesthésiques inflammables.
 - Mode de fonctionnement : En continu.
- Dispositif médical sur ordonnance**
- Le système constitue un dispositif médical sur ordonnance et ne doit être manipulé que par des prestataires de soins qualifiés.
- Précautions relatives au scanner**
- La tige émet une lumière laser rouge (680 nm classe 1) ainsi que des émissions LED blanches. L'utilisation normale de la tige ne présente aucun danger pour l'œil humain. Évitez de diriger la lumière de la tige directement dans les yeux du patient.
 - Évitez de tordre, de nouer, de tirer ou de marcher sur le câble de la tige et le câble d'alimentation.
 - Lorsque le système n'est pas utilisé, la tige doit être placée dans le socle avec la surface optique en face du socle, afin d'éviter tout contact visuel avec le faisceau laser ou l'émission de LED blanche clignotante. Le contact avec les yeux peut leur causer des dommages.
 - Évitez d'activer la tige lorsque la pointe de la tige est en dehors de la bouche du patient, afin d'éviter des lésions oculaires.
 - Évitez de placer la tige dans le socle pendant que l'opération de numérisation est toujours active, afin d'éviter des lésions oculaires.
 - N'utilisez pas l'équipement en cas de dysfonctionnement du scanner ou si des dommages physiques sont constatés, afin d'éviter tout choc électrique ou blessure physique. Appelez le Service clientèle.

Nettoyage & désinfection

Pour éviter la contamination croisée, il est obligatoire de :

- Nettoyer et désinfecter la tige, comme décrit dans [Cleaning and disinfecting the wand](#), et remplacer le wand sleeve, comme décrit dans [Applying a wand sleeve](#), avant chaque session patient.
- Enlever et remplacer les gants après chaque séance avec un patient.
- Jeter les gants déchirés, contaminés ou déjà enlevés.
- Changer la wand sleeve entre chaque patient. Ne pas changer la wand sleeve entre les patients peut entraîner le transfert par inadvertance de micro-organismes et d'autres contaminants d'un patient à un autre.
- Jeter les wand sleeves conformément aux procédures d'utilisation standard ou aux réglementations locales relatives à l'élimination des déchets médicaux contaminés.

Déballage & installation

Le système doit être déballé et installé conformément aux instructions fournies par Align Technology, décrites dans [Assembly instructions](#).

Remarque: contactez le service client si la boîte du scanner est endommagée ou si l'indicateur ShockDot sur la boîte a été activé.

Environnement de travail

- Le système doit être déplacé d'une pièce à une autre avec le plus grand soin pour éviter de l'endommager.
- N'obstruez pas les orifices d'aération de la tige et de l'unité informatique.
- Le système est conçu pour une utilisation en intérieur uniquement. Il ne doit pas être exposé directement à la lumière du soleil, à une chaleur excessive ou à l'humidité.
- iTero Element Flex seulement: si le système vient juste d'être déplacé dans un endroit en provenance d'un environnement chaud, froid ou humide, laissez le matériel s'adapter à la température ambiante pour éviter la condensation interne.

Précaution contre les interférences électromagnétiques

Cet appareil a été testé et approuvé conformément aux exigences des dispositifs médicaux selon la norme IEC60601-1-2. Cette norme est conçue pour fournir une protection raisonnable contre les interférences dangereuses dans une installation médicale classique.

Évitez de placer cet appareil à proximité d'équipements de transmission de fréquence ou d'autres sources d'interférences électriques et électromagnétiques (par exemple, téléphones portables, radios mobiles bidirectionnelles, appareils électriques, RFID). Des niveaux élevés de telles interférences, dus à la proximité ou à la force de la source, peuvent entraîner une perturbation des performances de cet appareil. Dans ce cas, l'appareil peut être remis en mode de fonctionnement après une intervention de l'utilisateur ou par une récupération automatique.

Informations générales**Remarques:**

- N'apportez aucune modification à cet équipement.
- Ne retirez pas l'unité de traitement du support après l'assemblage.

Notification d'incident

Tout incident grave lié à l'appareil iTero doit être signalé à Align Technology Ltd. et à l'autorité compétente du pays dans lequel l'utilisateur et le patient sont établis.

Table of contents

1	Introduction to iTero Element 2, iTero Element Flex, and iTero Element 2 Plus intraoral scanners	1
1.1	Intended purpose/Intended use	2
1.2	Indications for use	2
1.3	Contraindications	2
1.4	Intended patient population	2
1.5	Intended users	2
1.6	Use environment	2
1.7	Clinical benefits	2
1.8	iTero Element 2 and iTero Element 2 Plus hardware	3
1.8.1	iTero Element 2 wheel-stand configuration	3
1.8.2	iTero Element Flex	4
1.8.3	iTero Element 2 Plus cart configuration	5
1.8.4	iTero Element 2 Plus mobile configuration	6
1.8.5	iTero Element wand	7
1.9	About this manual	8
2	Assembly instructions	9
2.1	Assembling the iTero Element 2 scanner	10
2.2	Assembling the iTero Element Flex scanner	14
2.2.1	Installing the iTero Element Flex software	14
2.3	Assembling the iTero Element 2 Plus scanner – cart configuration	16
2.4	Assembling the iTero Element 2 Plus scanner – mobile configuration	21
2.4.1	Initial assembly	22
2.4.2	Moving the scanner within the clinic	24
2.4.3	Using the trolley for transportation	24
2.4.4	Optional protective trolley cover	27
2.4.5	VESA mounting	27
3	Getting started	30
3.1	Logging in to the scanner for the first time	30
3.2	Registering the scanner – Make It Mine process	30
4	Working with the scanner	37
4.1	Logging in to the scanner	37
4.1.1	Resetting your password	41

4.1.2	Installing Windows security updates	43
4.2	Logging out of the scanner	48
4.3	Shutting down the scanner	49
4.4	Moving the scanner	49
4.4.1	Moving the iTerо Element 2 wheel-stand configuration scanner	49
4.4.2	Transporting the iTerо Element Flex intraoral scanner	49
4.4.3	Moving the iTerо Element 2 Plus cart-configuration scanner	50
4.4.4	Carrying the iTerо Element 2 Plus mobile-configuration scanner within the clinic	51
4.4.5	Transporting the iTerо Element 2 Plus mobile-configuration scanner between clinics	52
4.5	User interface	53
4.5.1	Scanner toolbar	56
4.5.2	Touch-screen gestures	59
4.6	Defining the scanner settings	60
4.6.1	Defining the Device settings	61
4.6.2	Defining the User settings	65
4.6.3	Defining the System settings	71
5	Starting a new scan	77
5.1	Applying a wand sleeve	77
5.2	Starting the scanning process	78
5.3	Filling in the Rx	79
5.3.1	Filling in the Rx for Study Model/iRecord procedures	82
5.3.2	Filling in the Rx for Invisalign procedures	83
5.3.3	Filling in the Rx for Fixed Restorative procedures	85
5.3.4	Filling in the Rx for Implant Planning procedures	98
5.3.5	Filling in the Rx for Denture/Removable procedures	101
5.3.6	Filling in the Rx for Appliance procedures	104
5.4	Patient management	105
5.4.1	Adding new patients	105
5.4.2	Searching for existing patients	106
5.4.3	Editing the patient details	108
5.4.4	Clearing the patient details from the New Scan window	110
5.5	Scanning the patient	111
5.5.1	Scanning guidance	111
5.5.2	Scanning best practices	113
5.5.3	Scan options	113

5.5.4	Editing a scan	115
5.6	Viewing the scan	116
5.6.1	Missing scan segment notifications	117
5.6.2	Using the scan timer	118
5.7	Sending the scan	118
5.8	Working with the Viewer	122
5.9	Removing the wand sleeve	125
6	Working with patients	127
6.1	Searching for patients	127
6.2	Viewing the patient details	129
6.3	Creating a new scan for a specific patient	130
6.4	Viewing the Rx	132
6.5	Viewing previous scans in the Viewer	133
7	Working with orders	135
7.1	Working with returned orders	138
8	Viewing messages	139
9	Working with MyiTero	140
10	iTero scanner features and tools	141
10.1	Comparing previous scans using iTero TimeLapse technology	141
10.2	Invisalign Outcome Simulator Pro	145
10.3	Invisalign Outcome Simulator	145
10.4	Invisalign Progress Assessment	145
10.5	Invisalign Go system	146
10.6	Editing tools	146
10.6.1	Deleting a segment	147
10.6.2	Deleting a selection	149
10.6.3	Filling in missing anatomy	151
10.6.4	Disabling auto-cleanup	152
10.7	Working with the Eraser tool	154
10.8	Working with the Occlusal Clearance tool	156
10.9	Working with the Edge Trimming tool	160
10.10	Working with the Die Separation tool	162
10.11	Working with the Margin Line tool	166
10.11.1	Automatically defining the margin line	166
10.11.2	Manually defining the margin line	168

10.12	Working with the Snapshot tool	168
11	Care and maintenance	174
11.1	Handling the wand and cable	174
11.2	Cleaning and disinfecting the wand	174
11.2.1	Preparation before cleaning and disinfection	175
11.2.2	Wand cleaning and disinfection	176
11.2.3	Drying – wand body	177
11.2.4	Storage and maintenance	177
11.3	Cleaning and disinfecting the cradle	178
11.3.1	Preparation before cleaning and disinfection	178
11.3.2	Cradle cleaning and disinfection	179
11.3.3	Drying – cradle	180
11.3.4	Storage and maintenance	181
11.4	Cleaning and disinfecting the scanner touch screen and the wheel-stand handle	181
11.5	General cleaning	181
11.6	Approved cleaning and disinfecting materials	182
A	Clinic LAN network guidelines	183
A.1	Introduction	183
A.2	Preparations	183
A.3	Router guidelines	184
A.4	Internet connection guidelines	184
A.5	Firewall	184
A.6	Wi-Fi tips	184
A.7	Align hostname recommendations	185
B	EMC declarations	186
B.1	EMC declaration – iTerо Element 2 and iTerо Element Flex	186
B.2	EMC declaration – iTerо Element 2 Plus	189
C	iTerо Element product security whitepaper	192
D	System specifications	195
D.1	iTerо Element 2 system specifications	196
D.2	iTerо Element Flex system specifications	197
D.3	iTerо Element 2 Plus system specifications	198

Table of figures

Figure 1: Front view of the iTero Element 2 intraoral scanner	3
Figure 2: Rear view of the iTero Element 2 intraoral scanner	4
Figure 3: iTero Element Flex intraoral scanner	4
Figure 4: Front view of the iTero Element 2 Plus cart-configuration intraoral scanner	5
Figure 5: Rear view of the iTero Element 2 Plus cart-configuration intraoral scanner	6
Figure 6: Front view of the iTero Element 2 Plus mobile-configuration intraoral scanner	6
Figure 7: Rear view of the iTero Element 2 Plus mobile-configuration intraoral scanner	7
Figure 8: iTero Element wand	7
Figure 9: Protective sleeve	8
Figure 10: Disposable sleeve	8
Figure 11: Removing the wand from the cradle	20
Figure 12: Moving the scanner	20
Figure 13: Do not lift the scanner using the main handle	20
Figure 14: Do not allow the power pack to dangle in the air	29
Figure 15: Never tilt the screen more than 45 degrees	29
Figure 16: Welcome screen	30
Figure 17: Connect page listing the available networks	31
Figure 18: Entering the security key	31
Figure 19: Scanner is connected to the Internet and online	32
Figure 20: Verifying the communication with Align	32
Figure 21: Selecting the time zone	33
Figure 22: Registering the system to customize the setup	33
Figure 23: Example of an iTero subscription package	34
Figure 24: License agreement	34
Figure 25: Checking for updates	35
Figure 26: System is registered and ready	35
Figure 27: Login window	37
Figure 28: Unexpected shutdown notification	38
Figure 29: Password is masked	39
Figure 30: iTero home screen	40
Figure 31: Forgot Password button	41
Figure 32: Email field for forgotten password	41

Figure 33: Security answer field42

Figure 34: Security Updates window - scheduling options 43

Figure 35: Connect the scanner to the AC power 44

Figure 36: Installation in progress 44

Figure 37: Installation completed successfully 45

Figure 38: Security updates – number of days until the updates must be installed 45

Figure 39: Security updates – last day 46

Figure 40: Security updates notification – Login window 47

Figure 41: Security updates notification – home screen 48

Figure 42: iTero Element Flex intraoral scanner in the supplied carrying case50

Figure 43: Moving the scanner 51

Figure 44: Carrying the scanner between rooms within the clinic52

Figure 45: Transporting the scanner between clinics 52

Figure 46: iTero home screen53

Figure 47: Percentage of remaining battery charge 54

Figure 48: Help overlay including the e-manual and Customer Support buttons 55

Figure 49: Scanner toolbar56

Figure 50: Percentage of remaining battery charge 57

Figure 51: Help overlay including e-manual and Customer Support buttons 58

Figure 52: Settings window 60

Figure 53: Brightness settings 61

Figure 54: Volume settings61

Figure 55: List of nearby Wi-Fi networks 62

Figure 56: Connecting to the clinic Wi-Fi network 63

Figure 57: Forgetting or Disconnecting from the network 63

Figure 58: Time zone settings 64

Figure 59: Scan Settings window 65

Figure 60: Only the scanning range is highlighted67

Figure 61: Rx Settings window 68

Figure 62: Signature Settings window70

Figure 63: Language Settings window 71

Figure 64: Login Settings window 72

Figure 65: Diagnostics window 73

Figure 66: Licensing Information window 74

Figure 67: System Information window – iTero Element 2 Plus 75

Figure 68: Export Settings window – deleting exported files	76
Figure 69: Gently slide the new sleeve into place	77
Figure 70: New Scan window showing an empty Rx form and progress toolbar	78
Figure 71: New Scan window	80
Figure 72: Selecting the required procedure	81
Figure 73: Order and Scan Options areas – Study Model/iRecord procedure	83
Figure 74: Order area – Invisalign procedure	84
Figure 75: Scan Options and Tooth Diagram areas – Fixed Restorative procedure	86
Figure 76: List of fixed restorative treatment options	87
Figure 77: Treatment settings window – Onlay restoration	87
Figure 78: Selected tooth and Treatment Information area – Onlay restoration	88
Figure 79: Treatment settings window – Crown restoration	89
Figure 80: Additional information area – Crown restoration	90
Figure 81: Selected tooth and Treatment Information area – Crown restoration	91
Figure 82: Copy restoration settings from a tooth requiring the same treatment type	91
Figure 83: Treatment settings window – Implant Based restoration	92
Figure 84: Expanded Restoration Type area	93
Figure 85: Expanded Crown area	93
Figure 86: Treatment settings window – Bridge restoration	94
Figure 87: Bridge range and teeth to be included	94
Figure 88: List of in-bridge treatment options	95
Figure 89: Bridge restoration – Pontic settings	95
Figure 90: Additional information area – Bridge restoration	96
Figure 91: Bridge treatment options – Implant Based	97
Figure 92: Expanded Restoration Type area	97
Figure 93: Expanded Crown area	98
Figure 94: Implant Planning procedure types	98
Figure 95: Implant Planning procedure – Tooth Diagram for Surgical Guide Tooth Supported	99
Figure 96: Defining the teeth that need to be implanted	100
Figure 97: Implant Position window	100
Figure 98: Supporting teeth and teeth to be implanted displayed in the Tooth Diagram and Treatment Information areas	101
Figure 99: Denture/Removable procedure types	102
Figure 100: Defining the teeth to be included in the denture – Full Denture Implant Based procedure type	102
Figure 101: Implant Based settings window	103

Figure 102: Appliance procedure types 104

Figure 103: Adding a new patient 105

Figure 104: Message notifying that a patient with the same details exists 106

Figure 105: Patient area of the New Scan window – searching for an existing patient 106

Figure 106: Search Patient window with a search field 107

Figure 107: Search criteria in the search field and list of matching patients 107

Figure 108: Selecting the required patient 108

Figure 109: Selected patient displayed in the Patient area of the New Scan window 108

Figure 110: Patient area of New Scan window – editing a patient 109

Figure 111: Edit Patient window and Update button 109

Figure 112: Message that a patient with the same details already exists 110

Figure 113: Clear patient details button 110

Figure 114: Clear confirmation message 111

Figure 115: Recommended scanning sequence – lower jaw 112

Figure 116: Wand guidance 112

Figure 117: Areas with missing anatomy shown with and without additional scan feedback – monochrome 113

Figure 118: Areas with missing anatomy shown with and without additional scan feedback – color mode 114

Figure 119: Model displayed in color and monochrome mode 114

Figure 120: Tap the opposite arch or tap the arrows to select it 115

Figure 121: Editing tools 116

Figure 122: Missing scan message and missing segments highlighted in red 117

Figure 123: Scan timer button on the toolbar and scan time 118

Figure 124: Notification about missing treatment information 119

Figure 125: Missing fields highlighted in red in the Treatment Information area 119

Figure 126: Send Confirmation window 120

Figure 127: Invisalign Outcome Simulator Pro progress shown in the Viewer 121

Figure 128: Invisalign Outcome Simulator Pro progress shown in the patient's profile page 121

Figure 129: Viewer option in the Past Orders pane in the Orders page 122

Figure 130: Viewer option in the patient's profile page 122

Figure 131: Model in a 1-window view 123

Figure 132: Model in a 2-window view 124

Figure 133: Model in a 5-window view 124

Figure 134: Removing a wand sleeve 125

Figure 135: Optical surface of the wand 126

Figure 136: Gently slide the new sleeve into place 126

Figure 137: Patients page	127
Figure 138: Searching for a patient	128
Figure 139: Patients matching the search criteria are displayed	128
Figure 140: Patient's profile page	129
Figure 141: Patient's profile page – New Scan option	130
Figure 142: New Scan window with patient's details already filled in	131
Figure 143: Patient's profile page – View Rx option	132
Figure 144: Rx Details window	133
Figure 145: Patient's profile page – Viewer option	134
Figure 146: Scan displayed in the Viewer	134
Figure 147: Orders page	136
Figure 148: In Progress pane – options	136
Figure 149: Past Orders pane – options	137
Figure 150: Orders button notifying a returned order	138
Figure 151: Returned order in the In Progress pane	138
Figure 152: Messages page	139
Figure 153: iTero TimeLapse – selecting the scans to compare	142
Figure 154: iTero TimeLapse window showing the highlighted changes between the scans	142
Figure 155: Area of interest from the first scan displayed in the animation window	143
Figure 156: Area of interest from the second scan displayed in the animation window	143
Figure 157: iTero TimeLapse scale options	144
Figure 158: Progress Assessment window	146
Figure 159: Editing tools	147
Figure 160: Delete Segment tool	148
Figure 161: Delete Selection tool	149
Figure 162: Expanded Delete Selection tool	150
Figure 163: Selected area of the anatomy is deleted	150
Figure 164: Fill tool	151
Figure 165: Areas that require scanning are highlighted in red – Fill tool	152
Figure 166: Auto-cleanup tool	153
Figure 167: Scan displayed with excess material showing	153
Figure 168: Eraser tool	154
Figure 169: Eraser tool options	154
Figure 170: Mark the area to be modified	155
Figure 171: Selected area removed, and scan tool enabled	155

Figure 172: Deleted area marked in red	156
Figure 173: Occlusal clearance between the opposing teeth	157
Figure 174: Occlusal Clearance range options	158
Figure 175: Occlusal Clearance tool and legend displayed in the Viewer	159
Figure 176: Edge Trimming tool	160
Figure 177: Edge Trimming tool options	160
Figure 178: Mark the area to be trimmed away	161
Figure 179: Selected area is highlighted, and the confirmation icon is enabled	161
Figure 180: Selected area has been removed	162
Figure 181: Green hint point centered on the prepped tooth	163
Figure 182: Die separation is displayed in high resolution	163
Figure 183: Die Separation tool options	164
Figure 184: Scan is displayed in low resolution	164
Figure 185: Before selecting the die separation	165
Figure 186: Prepped tooth is displayed in high resolution	165
Figure 187: Model display moves to the occlusal view, and zooms in on the prepped tooth	166
Figure 188: Margin Line tool options	167
Figure 189: Margin line is marked on the prepped tooth	167
Figure 190: Margin Line tool options	168
Figure 191: View mode – with Snapshot tool	169
Figure 192: Screen capture thumbnail is displayed after taking a screen capture	169
Figure 193: Screenshot with an annotations toolbar	170
Figure 194: Annotations toolbar	170
Figure 195: Adding text to the screenshot	171
Figure 196: Screenshot with annotations	171
Figure 197: Notification that the screenshots and annotations will be uploaded to MyiTero	172
Figure 198: Confirmation about the annotations being discarded	172
Figure 199: Notification that the screenshots will be uploaded to MyiTero	173
Figure 200: Option to download screenshots from the Orders page in MyiTero	173
Figure 201: Wand without a sleeve	175
Figure 202: Remove gross contaminants using CaviWipes1	176
Figure 203: Remove marks and stains using a soft bristle brush	176
Figure 204: Wipe the optical surface of the wand with IPA	177
Figure 205: Wiping the iTerо Element 2 cradle	179
Figure 206: Wiping the iTerо Element Flex cradle	179

Figure 207: Wiping the iTero Element 2 Plus cart-configuration cradle 179

Figure 208: Wiping the iTero Element 2 Plus mobile-configuration cradle 179

Figure 209: Brushing the iTero Element 2 cradle 180

Figure 210: Brushing the iTero Element Flex cradle 180

Figure 211: Brushing the iTero Element 2 Plus cart-configuration cradle 180

Figure 212: Brushing the iTero Element 2 Plus mobile-configuration cradle 180

1 Introduction to iTero Element 2, iTero Element Flex, and iTero Element 2 Plus intraoral scanners

iTero Element 2 intraoral scanners come in two configurations – wheel stand and laptop (iTero Element Flex).

The iTero Element 2 wheel-stand configuration scanner offers an all-in-one system available on a monitor with a fully interactive, touch-screen display and an easy-to-use wand. The topography of a patient's teeth can be viewed on the screen as they are being scanned, and determining the degree of occlusion of the bite can be analyzed when the scan is completed.

iTero Element Flex is a wand-only configuration with any laptop that meets our minimum system requirements, giving you the ultimate in mobility and the freedom to provide dedicated care wherever you choose to see patients.

The iTero Element 2 Plus family of imaging systems is Align Technology's latest generation of intraoral scanners, which comes in two configurations – cart and mobile.

The bright full HD touch-screen display has wide visualization angles for an immersive and engaging experience and the powerful computing power enables a smoother and intuitive scanning experience. The ergonomics and elegance of the cart configuration will enhance your experience and elevate your practice brand image. The mobile configuration, with its dedicated trolley, enables professional and convenient inter-office portability.

This all-in-one system is designed to take patient experience and your productivity to the next level, ultimately helping you to grow your practice while making things easier.

Refer to our website <http://www.itero.com> to learn how the iTero Service can enhance your business by increasing patient satisfaction and enhancing office efficiency.

1.1 Intended purpose/Intended use

The iTero Element 2, iTero Element Flex and iTero Element 2 Plus systems are intraoral scanners with the following features and intended use:

- The optical impression (CAD/CAM) feature of the scanner is intended/indicated for use to record the topographical images of teeth and oral tissue. Data generated from iTero may be used in conjunction with the production of dental devices (e.g. aligners, braces, appliances, etc.) and accessories.
- iTero software is used with the iTero scanner in capturing 3D digital impressions of teeth, oral soft tissue and structures, and bite relationship. The software controls the processing of the data, facilitating the integration of data, and exporting of the data for CAD/CAM fabrication of dental restorations, orthodontic devices, abutments, and accessories. In addition to scan data, various patient and case information can be imported/exported or used for simulation purposes. Other functions are available for verification and service of the system and to serve as an order management tool.

1.2 Indications for use

iTero Element scanners are indicated for use for orthodontic treatment planning and follow-up, restorative treatment planning and/or routine dental assessment.

1.3 Contraindications

For persons who have been diagnosed with Epilepsy, there is a risk of epileptic shock from the flashing light of the iTero scanner. These persons should refrain from any eye contact with the flashing light associated with the system during operation.

1.4 Intended patient population

The system may be used on patients classified as Preadolescent, Adolescent, and Adult

1.5 Intended users

The system serves as a prescription medical device and should be operated by trained health-care providers only.

1.6 Use environment

Professional Healthcare and Home Healthcare Facility environment.

1.7 Clinical benefits

Digital impressions improve patient comfort and speed of process as compared to conventional impressions.

1.8 iTero Element 2 and iTero Element 2 Plus hardware

The iTero Element 2 scanner is available in two models:

- [iTero Element 2 wheel-stand configuration](#)
- [iTero Element Flex](#)

The iTero Element 2 Plus scanner is available in two configurations:

- [iTero Element 2 Plus cart configuration](#)
- [iTero Element 2 Plus mobile configuration](#)

1.8.1 iTero Element 2 wheel-stand configuration

Front view of the system



- A Full HD touch screen
- B Power switch
- C Power LED
- D Wand
- E Cradle
- F Wheel base

Figure 1: Front view of the iTero Element 2 intraoral scanner

Rear view of the system



- A Wand connector
- B Wand cable
- C Screen power cable

Figure 2: Rear view of the iTero Element 2 intraoral scanner

1.8.2 iTero Element Flex



- A Laptop touch screen
- B iTero Element Flex hub
- C Wand and cradle

Figure 3: iTero Element Flex intraoral scanner

1.8.3 iTero Element 2 Plus cart configuration

Front view



- A Full HD touchscreen
- B Power switch
- C Main handle
- D Wand
- E Cradle
- F Wheel stand

Figure 4: Front view of the iTero Element 2 Plus cart-configuration intraoral scanner

Rear view

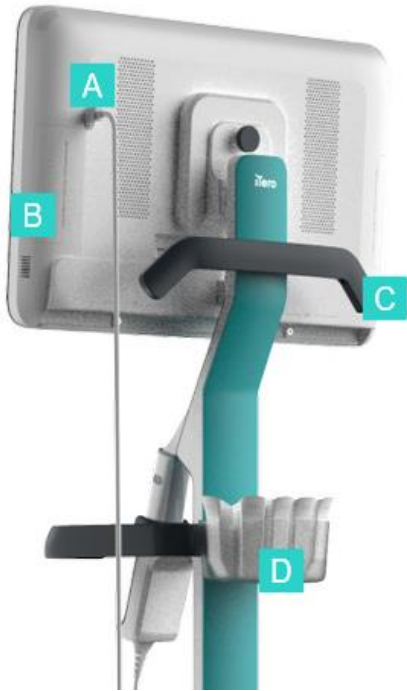

- A Wand connector
- B Diagnostics panel
(for Support purposes only)
- C Upper handle
- D New-sleeve basket

Figure 5: Rear view of the iTero Element 2 Plus cart-configuration intraoral scanner

1.8.4 iTero Element 2 Plus mobile configuration

Front view



- A Full HD touch-screen
computing unit
- B Wand
- C Cradle

Figure 6: Front view of the iTero Element 2 Plus mobile-configuration intraoral scanner

Rear view

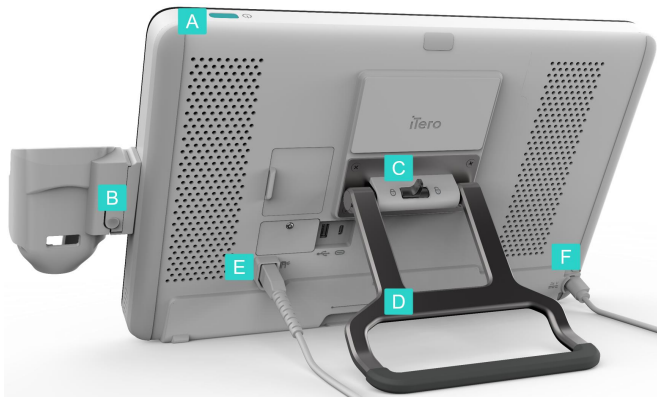

- A** Power switch
- B** Cradle release button
- C** Locking latch
- D** Carrying handle/stand
- E** Wand cable
- F** Power cable

Figure 7: Rear view of the iTero Element 2 Plus mobile-configuration intraoral scanner

1.8.5 iTero Element wand

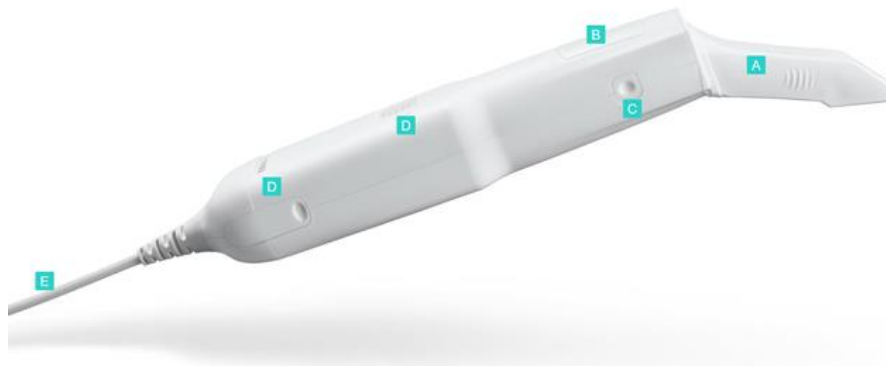

- A** Disposable sleeve
- B** Touchpad
- C** Side buttons: Scan, on/off, touchpad activation
- D** Air vents
- E** Detachable wand cable with USB connector

Figure 8: iTero Element wand

1.8.5.1 Wand sleeves

There are two types of wand sleeves:

- **Protective sleeve (blue)** Used when the scanner is not in use, to protect the optical surface of the wand.
- **Disposable sleeve:** Used while scanning. Before scanning the patient, attach a new disposable sleeve, as described in [Applying a wand sleeve](#).

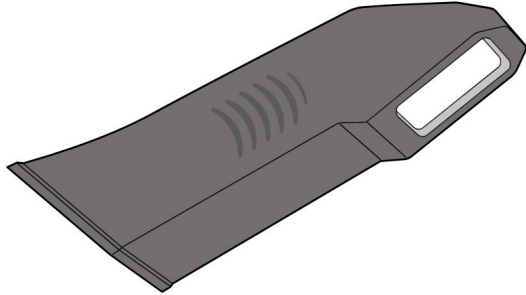

Figure 9: Protective sleeve

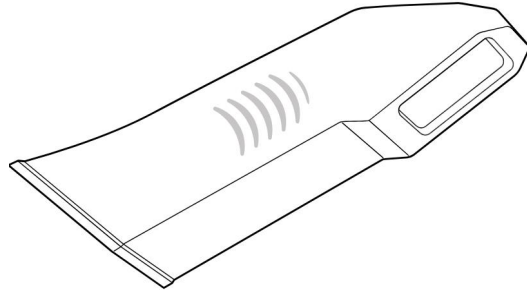

Figure 10: Disposable sleeve

1.9 About this manual

This manual provides general information and an overview of the iTero Element 2, iTero Element Flex, and iTero Element 2 Plus intraoral scanners and software.

In addition, this manual describes how to assemble the system, install the software on iTero Element Flex systems, start and shut down the system, clean and disinfect the system, and how to replace the wand sleeves between patients.

2 Assembly instructions

This section describes how to assemble your new scanner.

- [Assembling the iTero Element 2 scanner](#)
- [Assembling the iTero Element Flex scanner](#)
- [Assembling the iTero Element 2 Plus scanner – cart configuration](#)
- [Assembling the iTero Element 2 Plus scanner – mobile configuration](#)

2.1 Assembling the iTero Element 2 scanner

Follow the instructions below to assemble the iTero Element 2 wheel-stand configuration scanner.



AC power



Battery



Click



DC power



Power button



Wand



2 people are required for installation

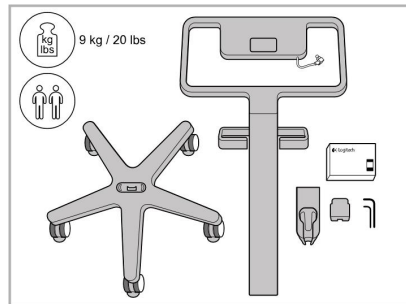
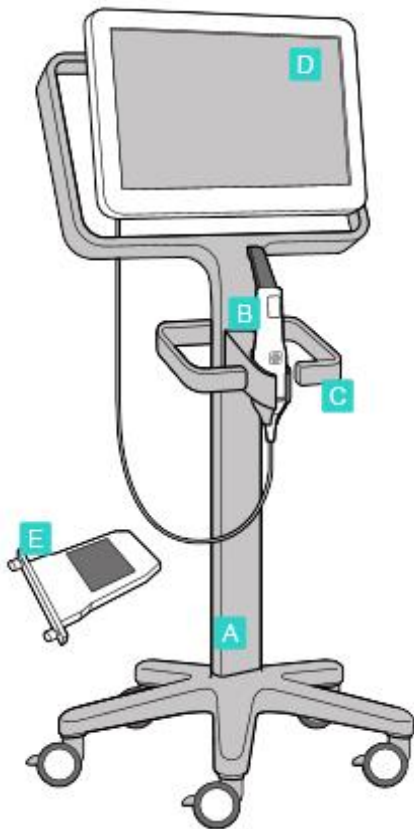

1. Check the contents of the boxes.

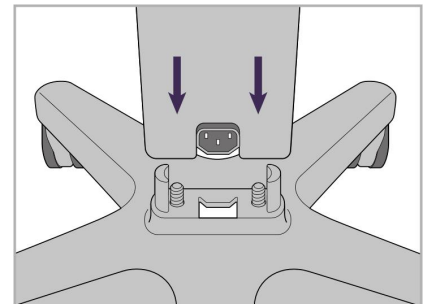

2. Connect the post to the wheel base.

- A Wheel stand
- B Wand with cable
- C Wand cradle
- D HD touch screen
- E External battery

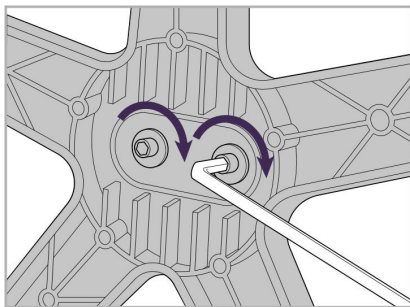

3. Tighten the two Allen screws using the larger Allen key.

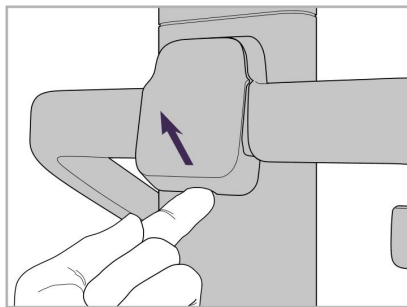

4. Remove the cover from the back of the handle.

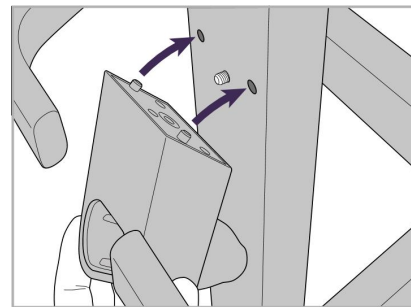

5. Attach the wand cradle to the front of the wheel stand.

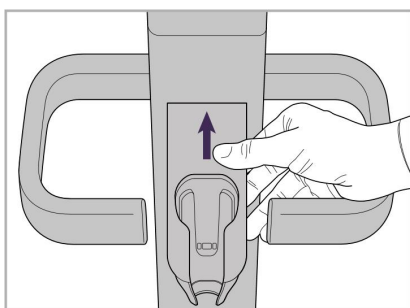

6. Hold the cradle.

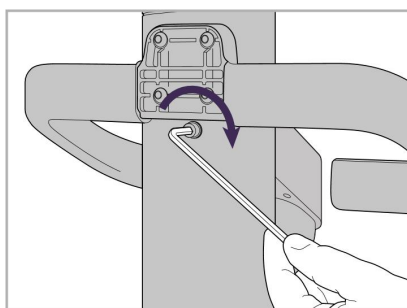

7. Tighten the back of the wand cradle with the Allen screw using the smaller Allen key.

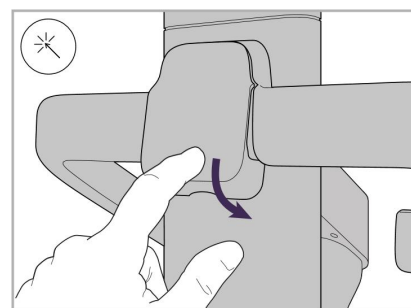

8. Reattach the cover behind the handle.

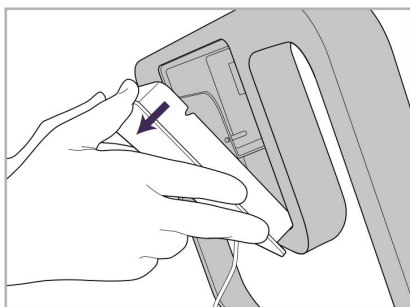

9. Remove the magnetic cover from the back of the wheel-stand frame.

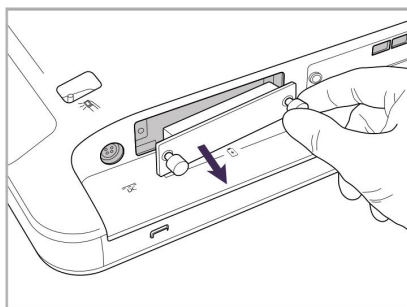

10. Loosen the thumbscrews and remove the battery cover.

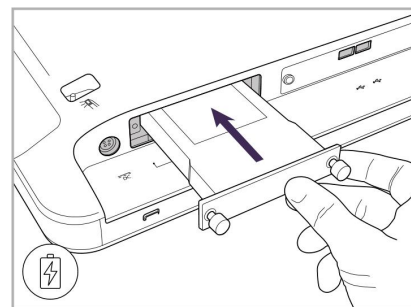

11. Slide the battery into the battery slot and tighten the thumbscrews.

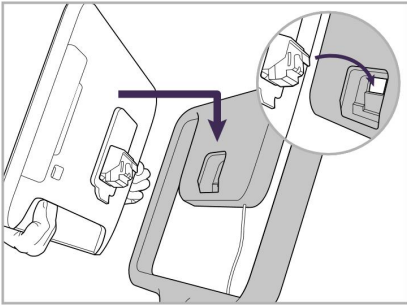

12. Lift the touch screen to mount it.

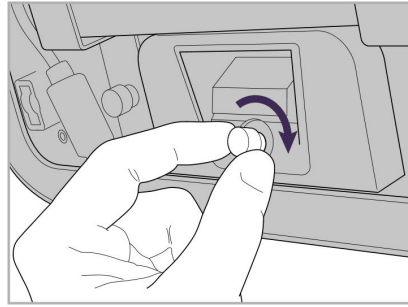

13. Turn the scanner around and tighten the thumbscrew to secure the screen.

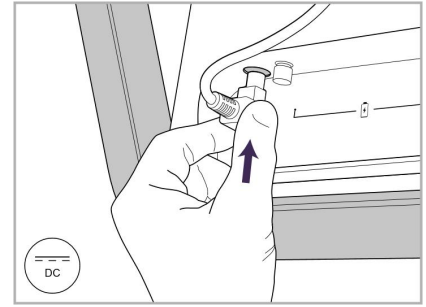

14. Connect the power cable to the port labeled DC, as shown in the next image.

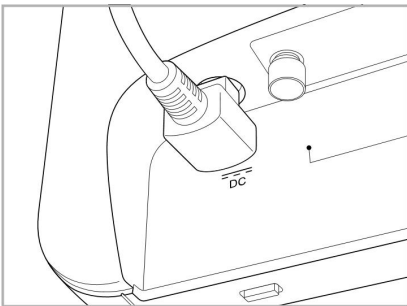

Power cable inserted.



15. Attach the magnetic back cover.

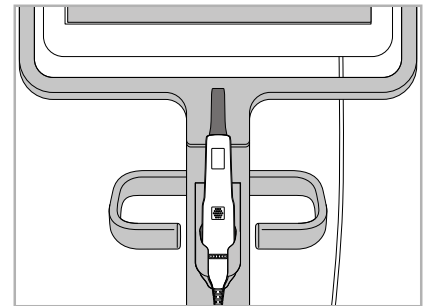

16. Place the wand in the cradle.

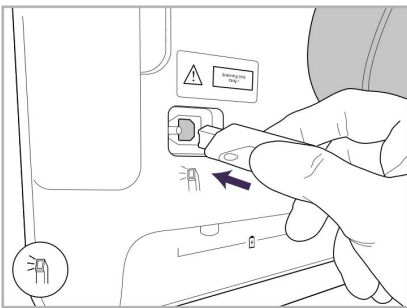

17. Connect the wand cable to the back of the touch screen.

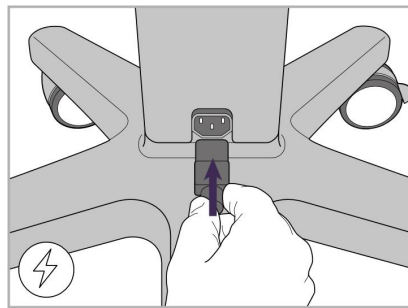

18. Connect the power cable on the bottom of the wheel stand.

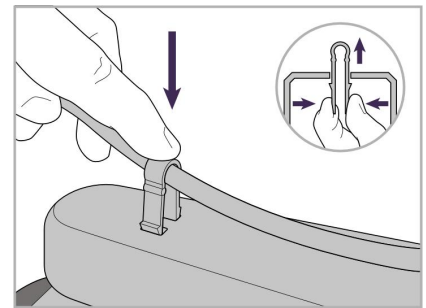

19. Secure the cable to the bottom of the wheel stand with the clip.

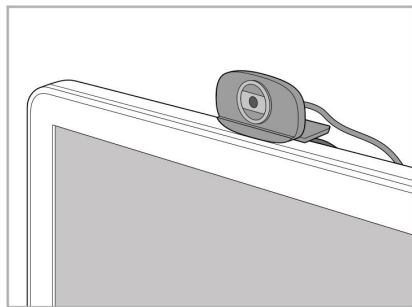

20. Position the webcam on the touch screen for remote training or support sessions.

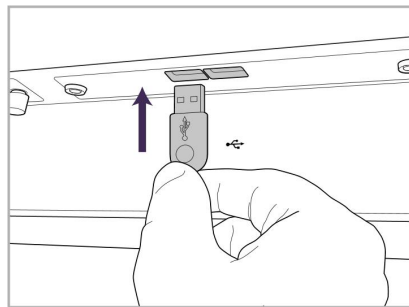

21. Connect the webcam to the USB port at the bottom of the touch screen.

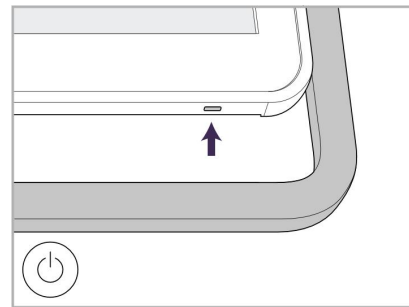

22. Plug the power cable into the AC power outlet and then press the Power button to switch on the scanner.

2.2 Assembling the iTero Element Flex scanner

Follow the instructions below to assemble the iTero Element Flex scanner.

- A Hub and hub power cable
- B Cradle
- C Wand and wand cable
- D USB cable to connect laptop and hub

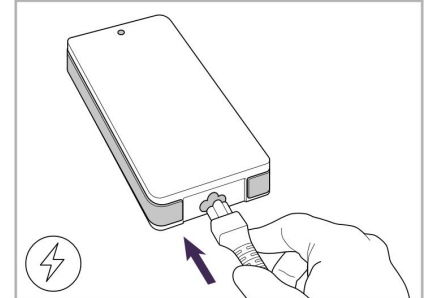
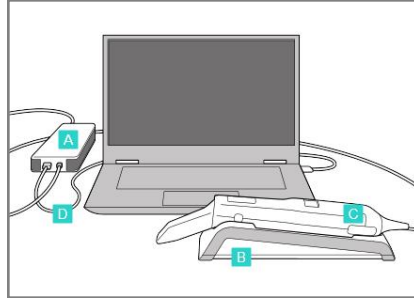

1. Place the wand in the cradle.

2. Connect the hub power cable to the hub.

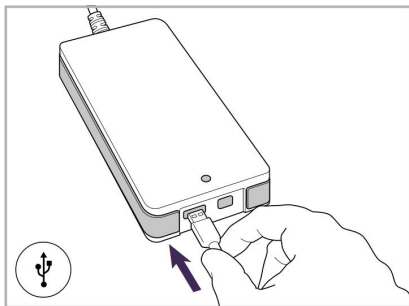

3. Connect the USB cable to the hub.

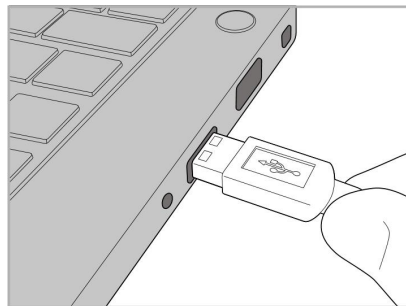

4. Connect the USB cable to the laptop.

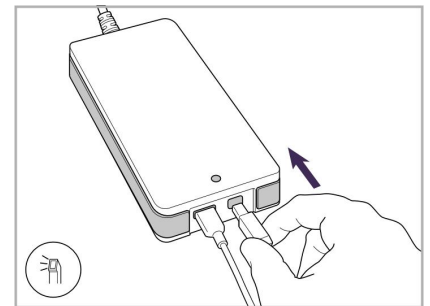

5. Connect the wand cable to the hub.

6. Plug the hub power cable into the AC power outlet.

Notes:

- The hub must be connected to an AC wall outlet at all times.
- The laptop should be connected to an AC wall outlet during intraoral scanning.

2.2.1 Installing the iTero Element Flex software

New iTero Element 2 systems come with the software installed, but the user must download and install the software on iTero Element Flex systems.

Notes:

- Before installing the iTero software, please install all available Windows updates. New Windows computers should apply the updates automatically.
- Ensure that one of the following compatible antivirus programs has been installed: Norton, McAfee, or ESET.

For proper software installation and configuration of the iTero Element Flex system, please ensure the following:

- The wand is secure in the cradle and connected to the hub
- The hub is connected to the laptop
- The laptop is plugged into the AC wall socket during the entire software installation

To install the iTero software:

1. Install all available Windows updates.
 - a. To check for Windows Updates, open the *Windows Settings* window (Winkey + I) and click **Update & Security**.
 - b. Click **Windows Update**.
 - c. Click **Check for updates** to see whether there are new updates available.
2. In the registered email Inbox, look for the email “Your iTero was shipped”, which includes the download instructions.
3. Click the link to access the software download page or browse to download.itero.com.
4. On the website, click the **Get Started** button. The **FirstTimeInstaller.exe** file will be downloaded.
5. Run the downloaded installation file and follow the instructions on the screen to complete the iTero software installation.

The *Welcome* screen is displayed. Proceed as described in [Registering the scanner – Make It Mine process](#).

2.3 Assembling the iTerо Element 2 Plus scanner – cart configuration

The scanner packaging is designed in a way that provides a simple and easy assembly process.

Follow the instructions below to assemble the scanner.

Contact iTero Support for additional help.

- A** 2x Allen keys
(in the white foam on top of the post)
- B** Post
- C** Wheel base
- D** Main handle
(in the accessory box)
- E** New-sleeve basket
(in the accessory box)
- F** Upper handle
(in the accessory box)
- G** Full HD touch-screen computing unit
- H** Cradle
- I** Wand
- J** Power cable
- K** Webcam
- L** Power switch

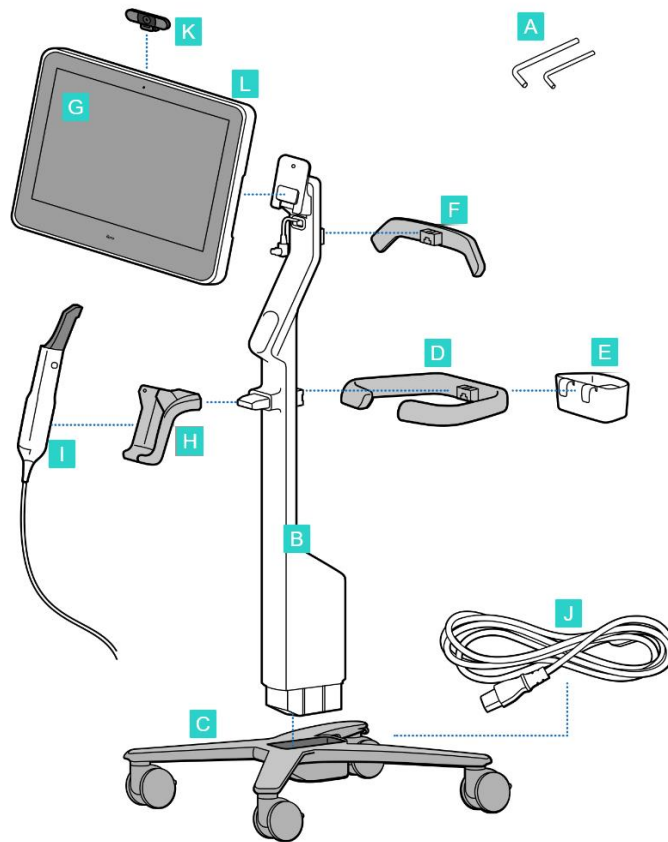

Note: If any damage to the system or accessories is found, do not assemble or use the scanner and contact iTero Support.

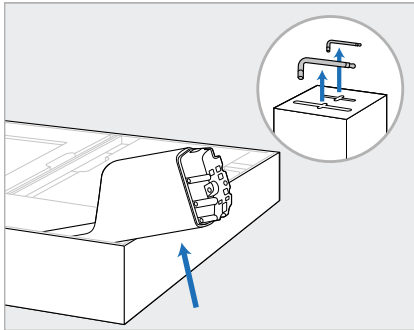

1. Remove all Styrofoam coverings from the box.
Note: The two Allen keys (A) are on top of the Styrofoam covering the post (B).
2. Lift the post (B), pull it out slightly, and rest it on the side of the box.

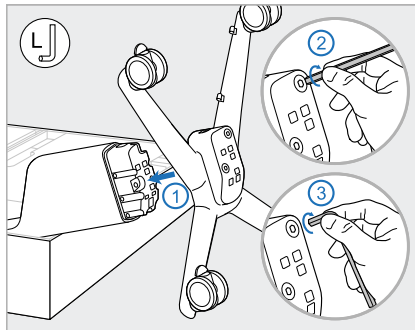

3. Attach the wheel base (C) to the end of the post (B) and tighten using first the longer side of the large Allen key and then the shorter side.

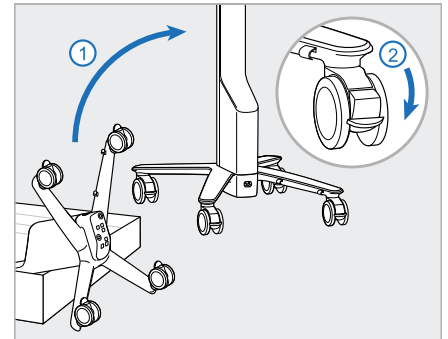

4. Move the wheel stand to an upright position and lock at least two wheels.

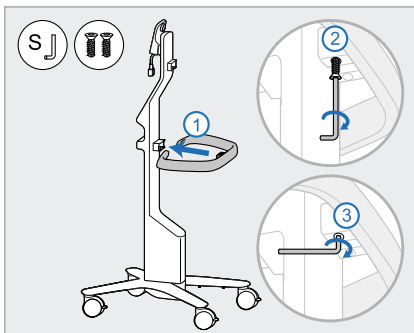

5. Remove the main handle (D) and the two screws from the accessory box. Attach the main handle and tighten using first the longer side of the small Allen key and then the shorter side.

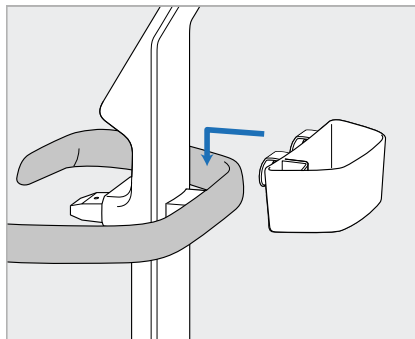

6. Remove the sleeve basket (E) from the accessory box and place it on the back of the main handle (D).

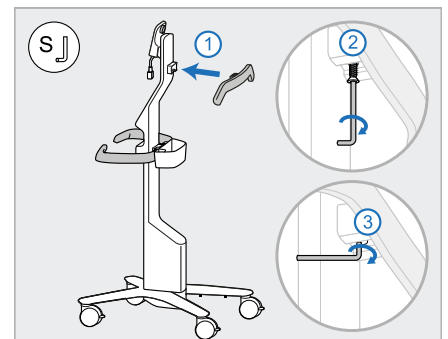

7. Remove the upper handle (F) from the accessory box and remove the pull tab to access the screw.
8. Attach the upper handle (F) to the post (B) and tighten using first the longer side of the small Allen key and then the shorter side.

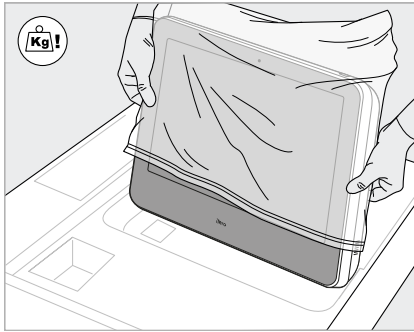

9. Carefully remove the computing unit (G) from its protective wrapping.
Note: The computing unit is heavy and must be lifted carefully.

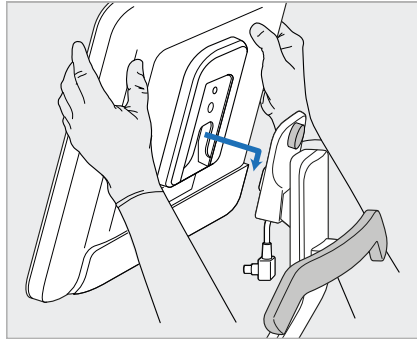

10. Standing behind the wheel stand, mount the computing unit (G) on the metal hinge and push down.
Note: Make sure the computing unit does not press on the screen cable. If it does, move the cable to the side.

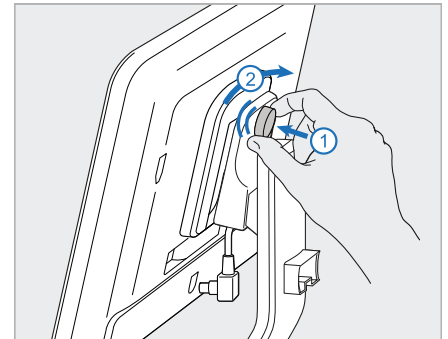

11. Attach the computing unit (G) by pushing in and tightening the screw.

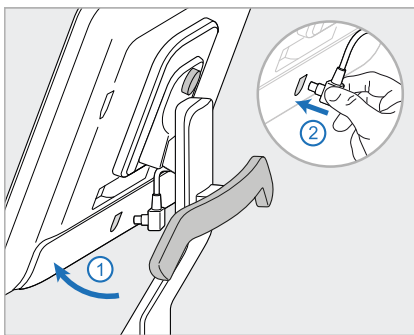

12. If the cable connector is covered, remove the cover.
 Tilt the screen upwards and connect the screen cable.

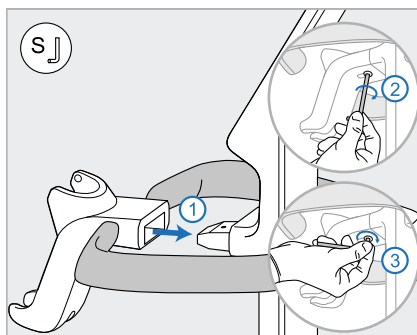

13. Attach the cradle (H) to the post (B) and tighten using first the longer side of the small Allen key and then the shorter side.

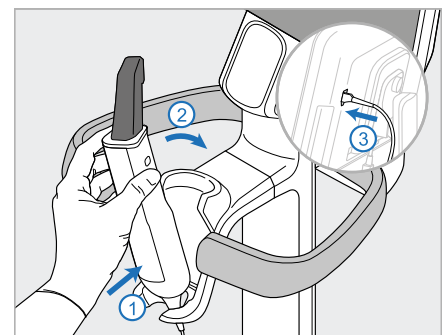

14. Insert the base of the wand (I) in the cradle (H) and then apply gentle pressure to make sure the wand is fully inserted and secure in the cradle.
 15. Connect the wand cable to the back of the screen (G).

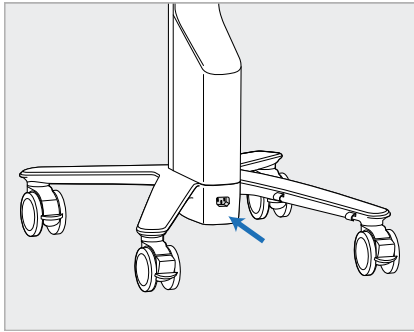

16. Connect the power cable (J) to the bottom of the wheel stand.
Warning: Use only the supplied power cable, which has a protective earth lead.

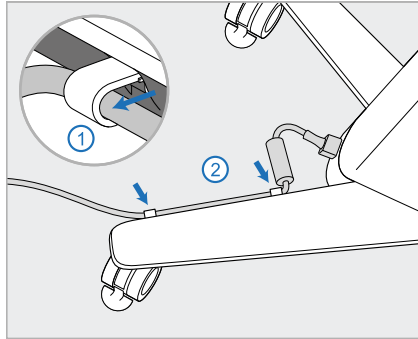

17. Secure the power cable (J) in the two cable clips, making sure it is fully inserted.

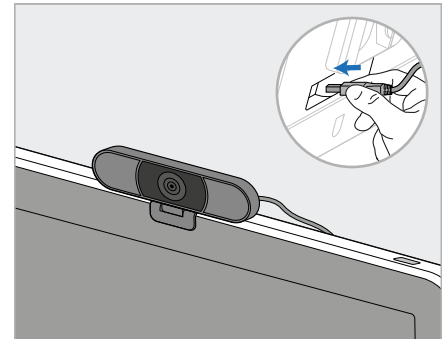

18. For remote training or support sessions, position the webcam (K) on the screen and then connect it to the USB port at the back of the screen.
Note: The webcam must be disconnected after each training or support session.

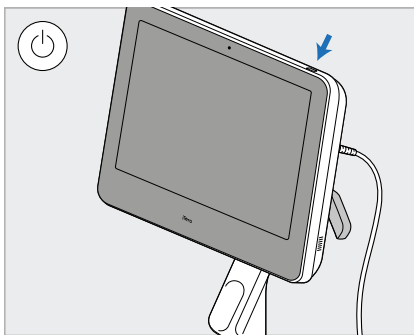

19. Plug the power cable (J) into a power outlet and then press the Power button (L) to switch on the scanner.

Notes:

- Always return the wand to the cradle after each use.
- The wand, cradle, and other system components should be cleaned and disinfected before each patient, as described in [Care and maintenance](#).
- Ensure that the scanner is positioned in a location where it can easily be disconnected from the power outlet.

To remove the wand from the cradle, first pull the upper part of the wand towards you and then gently remove it from the cradle.

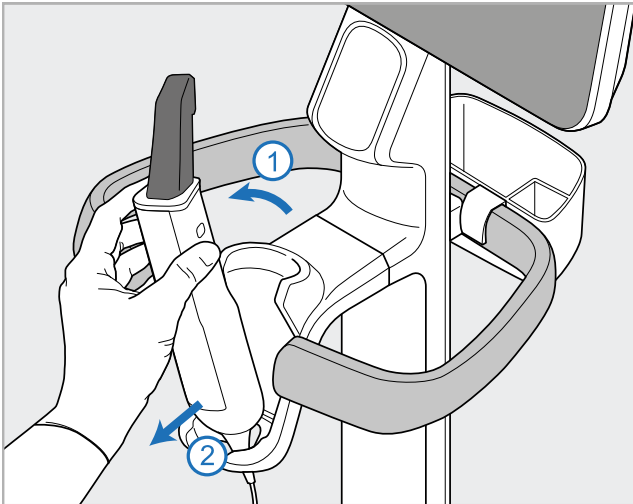

Figure 11: Removing the wand from the cradle

When moving the scanner, carefully wrap the power cable around the upper handle and then use the upper handle to push the scanner.

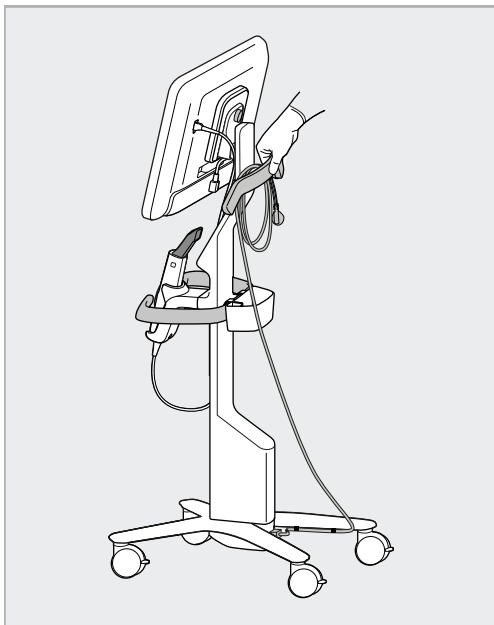

Figure 12: Moving the scanner

If the scanner needs to be lifted, use the upper handle and the post.

Do not use the main handle to lift the scanner.

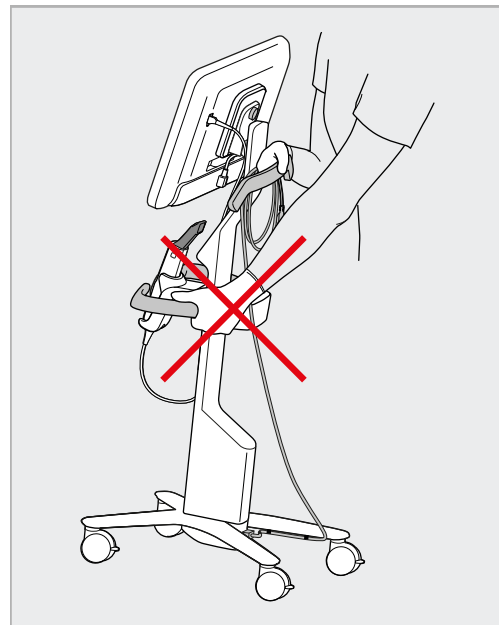

Figure 13: Do not lift the scanner using the main handle

2.4 Assembling the iTero Element 2 Plus scanner – mobile configuration

The scanner packaging is designed in a way that provides a simple and easy assembly process.

Follow the instructions below to assemble the scanner.

Contact iTero Support for additional help.

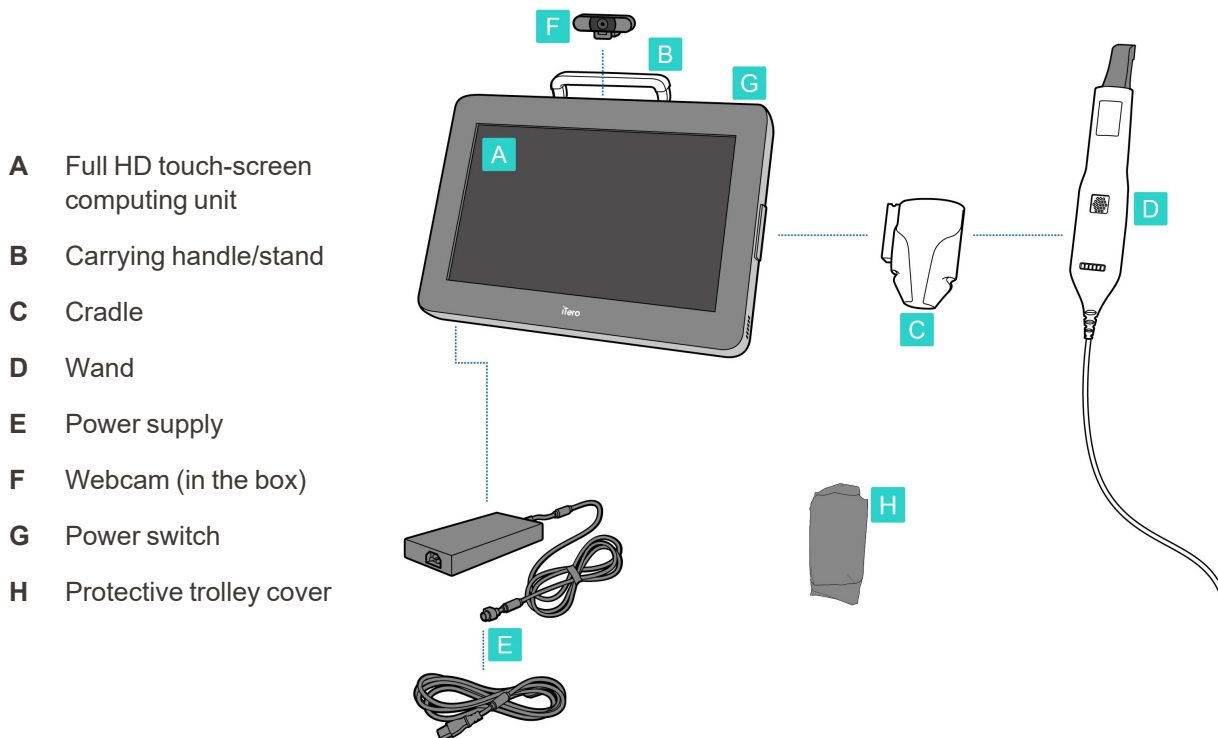

Note: If any damage to the system or accessories is found, do not assemble or use the scanner and contact iTero support.

This section describes how to:

- Assemble the scanner, described in [Initial assembly](#)
- Move the scanner within the clinic, described in [Moving the scanner within the clinic](#)
- Pack the scanner in the trolley before transporting it, described in [Using the trolley for transportation](#)
- Protect the trolley with the optional protective cover, described in [Optional protective trolley cover](#)
- Mount the scanner on a VESA mount, described in [VESA mounting](#)

2.4.1 Initial assembly

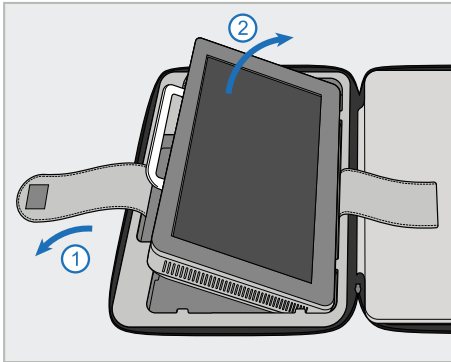

1. Undo the strap holding the computing unit (A), and then remove it using the handle (B).

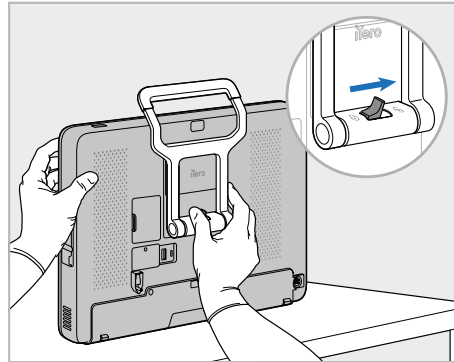

2. Rest the computing unit (A) on a smooth, flat surface and hold it with one hand.

While holding the computing unit, slide the locking latch to the right until you feel a click, to unlock the handle (B).

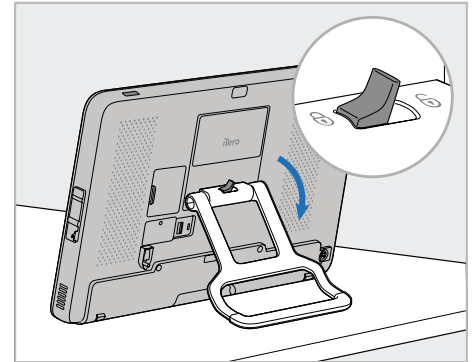

3. Move the handle (B) down to the standing position. Ensure that the handle is securely locked in place by trying to pull it back up.

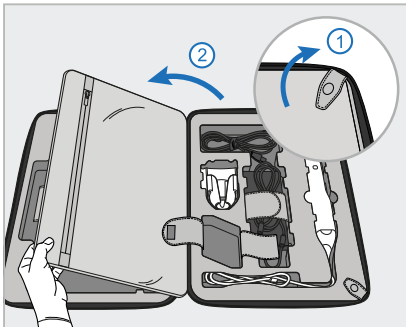

4. Undo the snaps and open the flap to remove the rest of the scanner components.

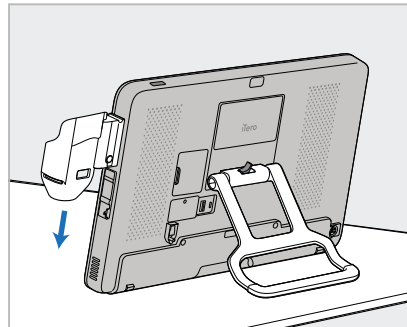

5. Slide down the cradle (C) on the slider on the side of the computing unit (A) until it clicks into place. Make sure the cradle is secure and cannot be removed.

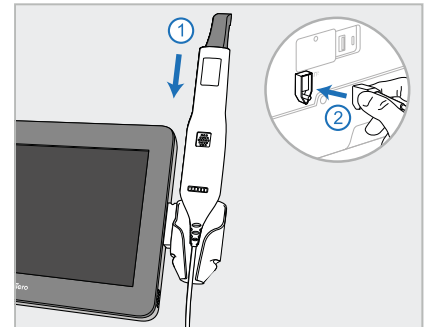

6. Place the wand (D) in the cradle (C) and connect the wand cable to the port marked **A** at the back of the computing unit (A).

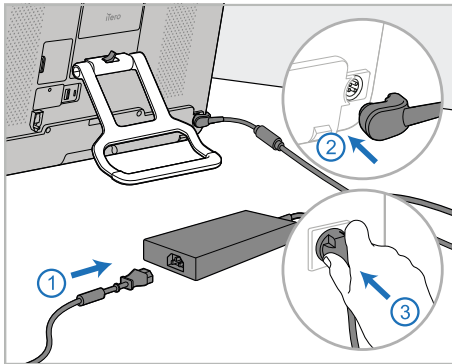

7. Connect the power cable to the power supply (E). Afterwards, connect one side of the cable to the back of the computing unit (A) and the other side to a power outlet.

Warning: Use only the supplied power cable, which has a protective earth lead.

Note: Place the cable in a safe manner so that no one is likely to accidentally trip over it.

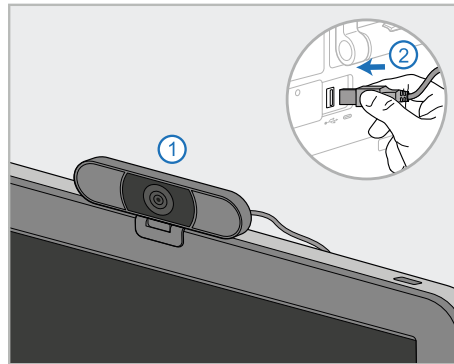

8. For remote training or support sessions, position the webcam (F) on the computing unit (A) and then connect it to the USB port at the back of the computing unit.

Note: The webcam is packed in the scanner box.

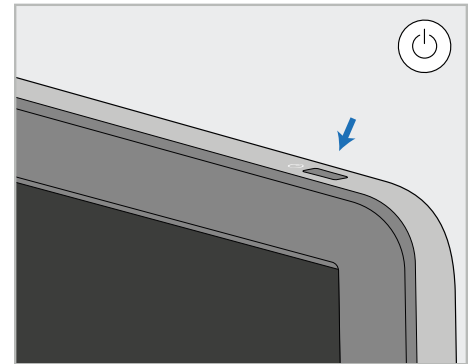

9. Press the power button (G) to turn on the scanner.

Notes:

- The webcam must be disconnected after each training or support session.
- Always return the wand to the cradle after each use.
- The wand, cradle, and other system components should be cleaned and disinfected before each patient, as described in [Care and maintenance](#).
- Ensure that the scanner is positioned in a location where it can easily be disconnected from the power outlet.

2.4.2 Moving the scanner within the clinic

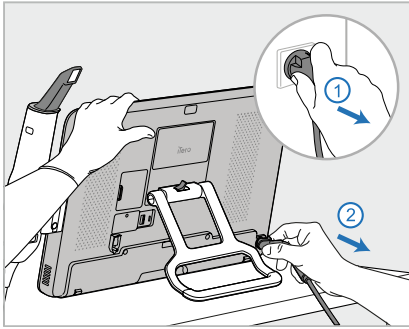

1. Ensure that the wand (D) is firmly positioned in the cradle (C).
2. Disconnect the power cable (E) from the mains and then from the back of the computing unit (A).

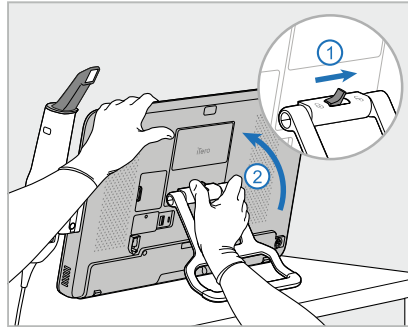

3. While holding the computing unit (A) with one hand, slide the locking latch to the right to unlock the handle (B) and then move the handle to the carrying position.

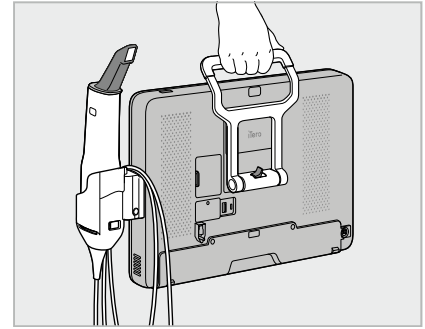

4. Loosely wrap the wand cable around the cradle (C) for easy and safe portability.

2.4.3 Using the trolley for transportation

Before transporting the scanner, it must be packed into the supplied trolley.

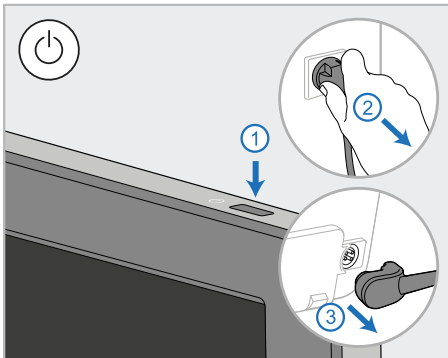

1. Turn off the scanner and disconnect the power cable (E) from the mains and then from the back of the computing unit (A).

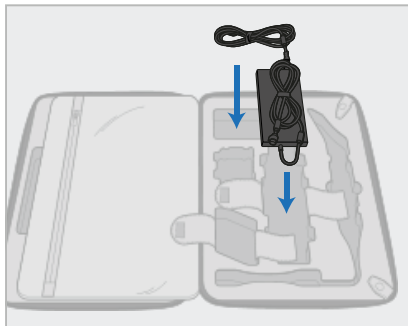

2. For easier packing, start by placing the power pack (E) in its designated compartment in the trolley. Wrap the thinner part of the cable and place it on top of the power supply, and then wrap the thicker part of the cable and place it in its compartment in the trolley.

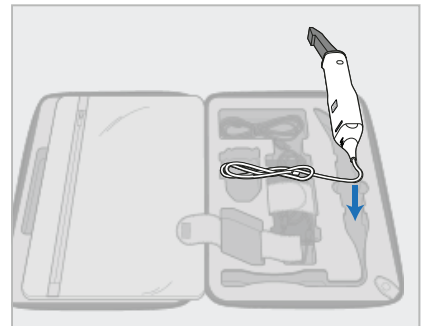

3. Disconnect the wand (D) and place it in its compartment in the trolley.

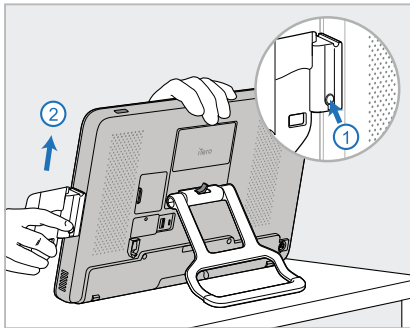

4. While holding the computing unit (A) with one hand, remove the cradle (C) by pressing the release button and pulling up the cradle.

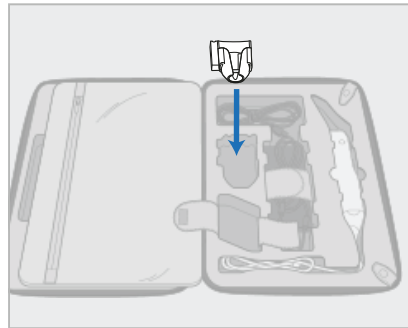

5. Place the cradle (C) in the trolley.

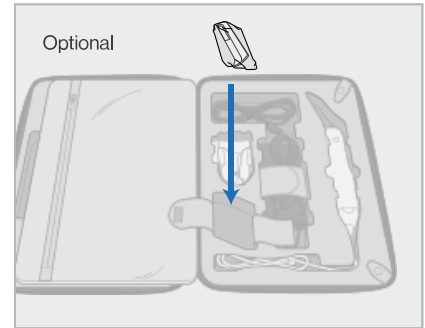

6. Optional: Place new sleeves in the compartment next to the cradle (C), instead of the protective trolley cover (H).

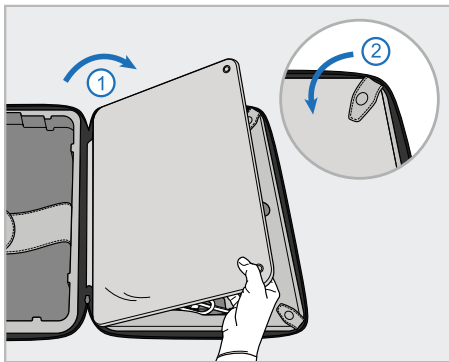

7. Move the flap to cover the scanner components and then secure the flap with the snaps.

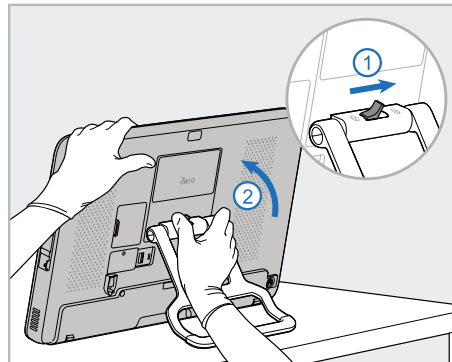

8. Slide the locking latch to the right to unlock the stand (B) and then move it to the carrying position.

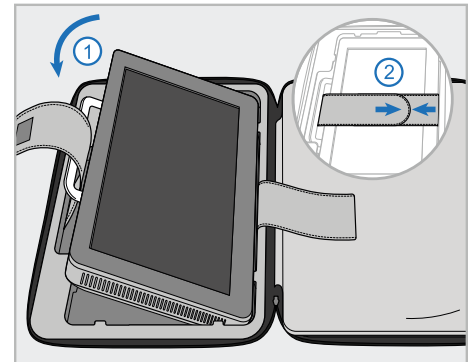

9. Place the computing unit (A) in its compartment in the trolley. Thread the outer strap through the handle (B) and close the straps to ensure that it is held securely in place.

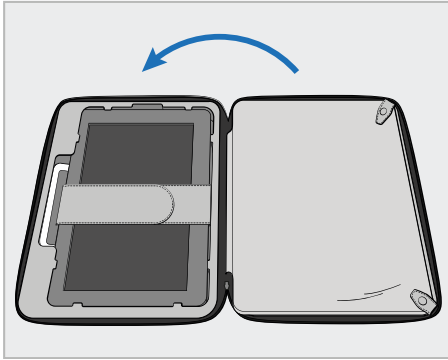

10. Close the trolley by lifting the side with the fastened flap and then zipping it closed.

You are now ready to travel with your scanner.
If required, you can use the optional protective trolley cover (H), described in [Optional protective trolley cover](#).

Notes:

- The trolley must be handled with care.
- Avoid leaving the trolley in the sun in order to prevent the scanner from reaching extreme temperatures.
- Make sure the trolley is kept dry to protect the system components from humidity.
- If the scanner has just been brought into the office from a hot, cold, or humid environment, it should be set aside until it has adjusted to room temperature, to avoid internal condensation.
- Do not check the trolley as baggage when traveling by air, to prevent damage to the scanner that may be caused by uncontrolled transportation conditions.

2.4.4 Optional protective trolley cover

The trolley is supplied with an optional protective cover that helps protect it against wear and tear and adverse weather conditions.

Note: The protective cover provides a certain level of protection against rain, but is not waterproof.

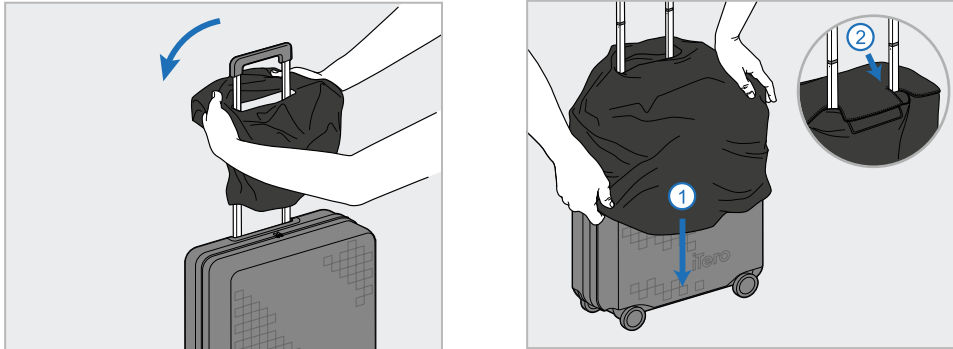

1. Open the VELCRO® flap and slip the protective cover (H) over the trolley handle.
2. Pull down to cover the trolley and then close the VELCRO® flap.

2.4.5 VESA mounting

The scanner provides a standard 100mm VESA mounting interface that can be used for mounting it using 3rd party VESA-based mounting solutions.

Notes:

- **Ensure that the selected VESA mounting solution supports the following scanner specifications:**
 - VESA 100mm
 - Minimum weight: 6kg (including the computing unit, wand, and cradle).
Recommended weight: 9kg.
- If the scanner has already been assembled, you must remove the power cable and the cradle, as described in [Using the trolley for transportation](#).
- We recommend that connecting the computing unit to the VESA mount, step 3 below, be performed by two people.

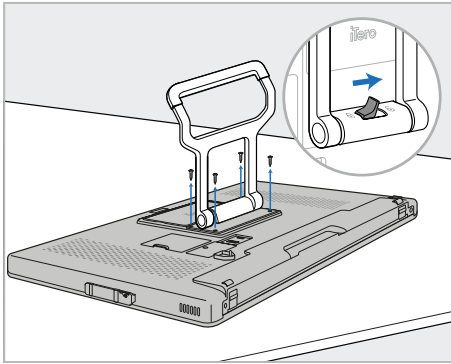

1. Lay the computing unit (A) face down on a smooth, flat surface.
Remove the 4 screws with a Phillips screwdriver, while holding and moving the handle (B), as required.

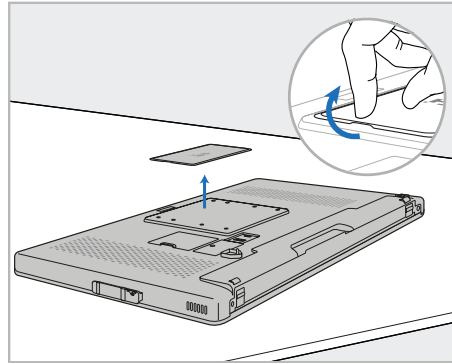

2. Remove the iTero back cover plate to expose the VESA screw holes. (It is recommended to store the cover plate and screws in the trolley.)

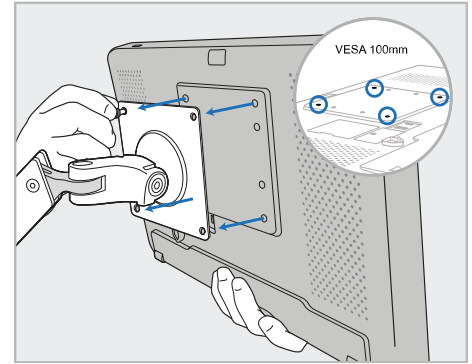

3. Connect the computing unit (A) to the external VESA mount (VESA 100) using the screws supplied with the mounting solution.
Optional: You can purchase a 3m power cable from Align, if required.

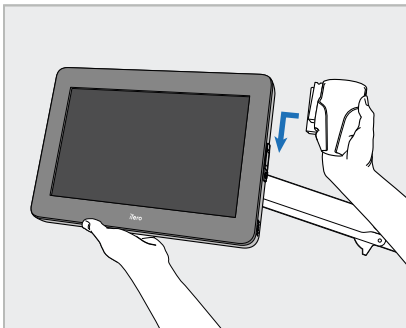

4. While supporting the computing unit (A) with one hand, slide the cradle (C) on the slider on the side of the computing unit until it clicks into place.
Make sure the cradle is secure and cannot be pulled off.

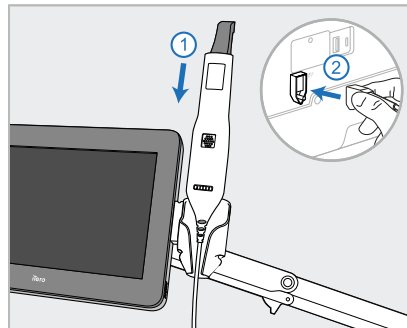

5. Place the wand (D) in the cradle (C) and connect the wand cable to the port marked **A** at the back of the computing unit (A).

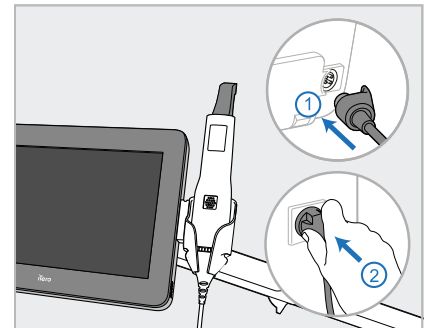

6. Connect the power cable (E) to the back of the computing unit (A) and then to the mains.

Notes:

- Ensure that the power pack rests on the floor or on a table and does not dangle in the air.

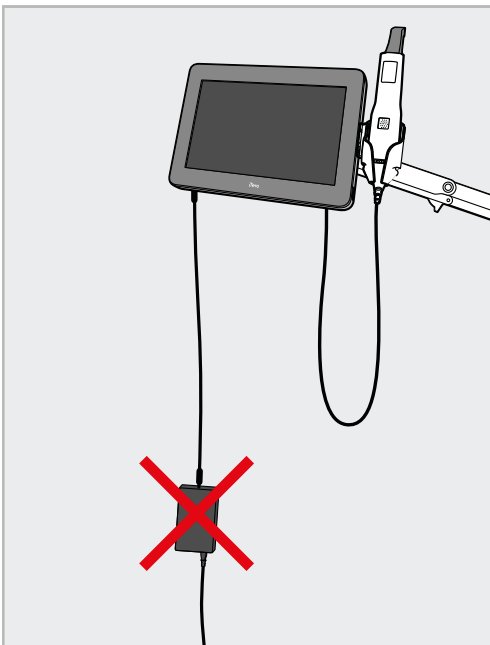

Figure 14: Do not allow the power pack to dangle in the air

- Never tilt the screen more than 45 degrees to make sure that the wand does not slip out of the cradle.

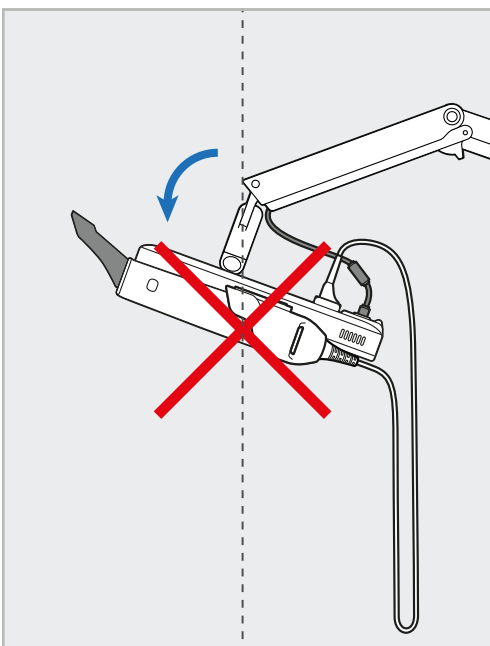

Figure 15: Never tilt the screen more than 45 degrees

3 Getting started

3.1 Logging in to the scanner for the first time

When you turn on the scanner for the first time, the *Welcome* screen is displayed:

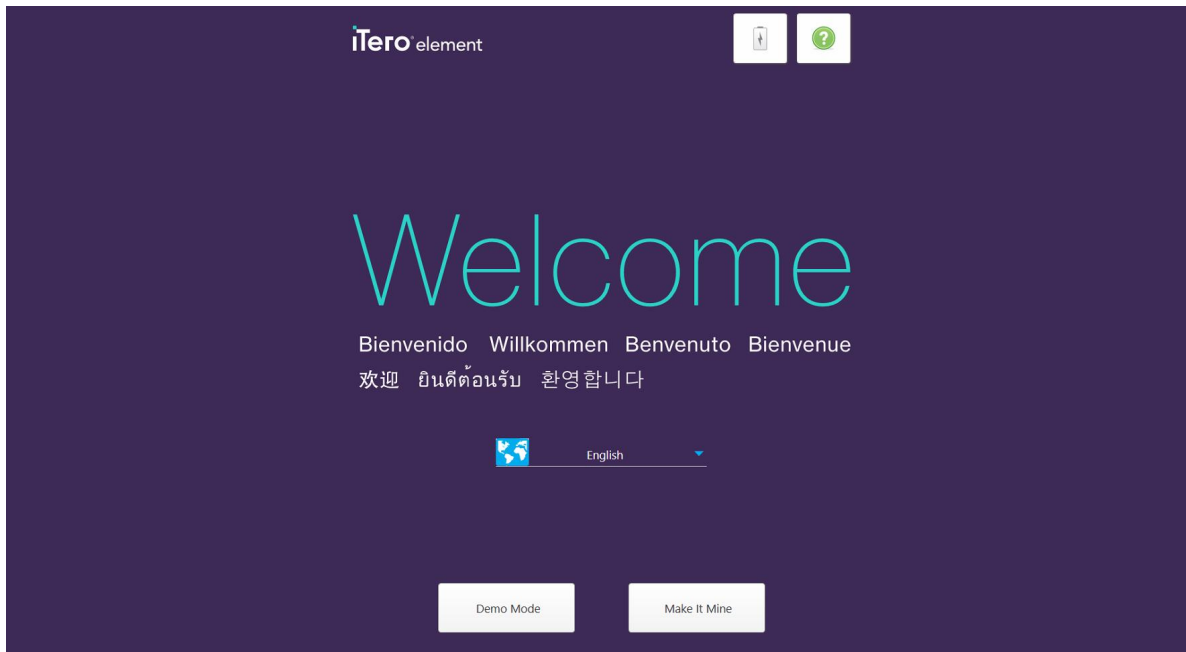

Figure 16: Welcome screen

Select the required language and the **Make It Mine** option.

3.2 Registering the scanner – Make It Mine process

When registering the scanner, you need the following details to complete the registration process:

- User Name
- User Password
- Company ID

You will receive an email from an iTero representative with login credentials and detailed information on how to proceed with the **Make It Mine** process.

To register the scanner:

1. In the *Welcome* page, select the required language.

2. Tap **Make It Mine**.

The *Connect* page is displayed, showing a list of available networks.

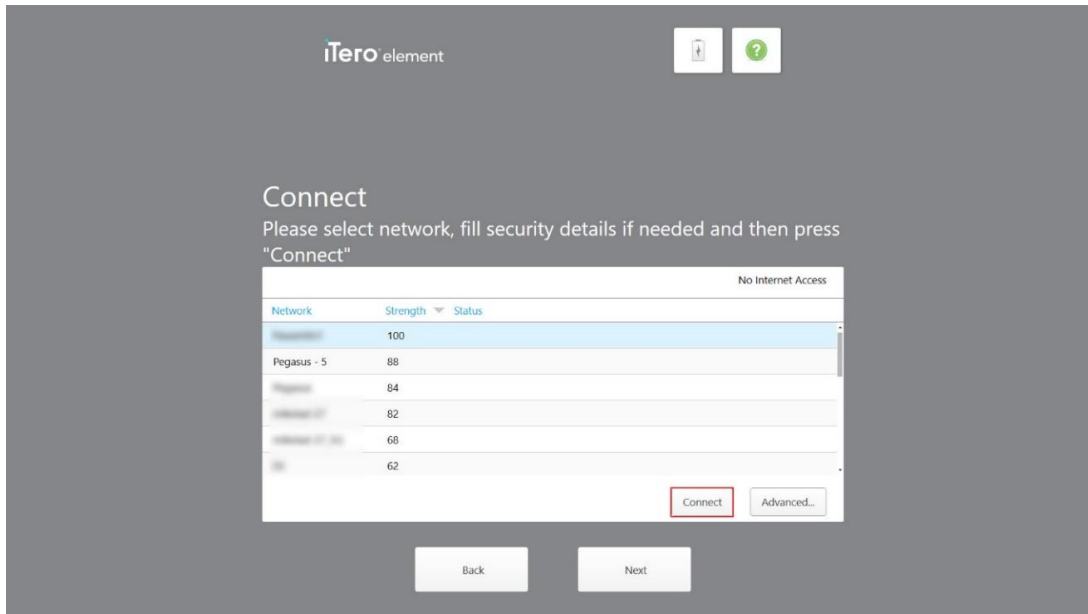

Figure 17: Connect page listing the available networks

3. Select the clinic network from the list and then tap **Connect**.

You are prompted to enter the network security key.

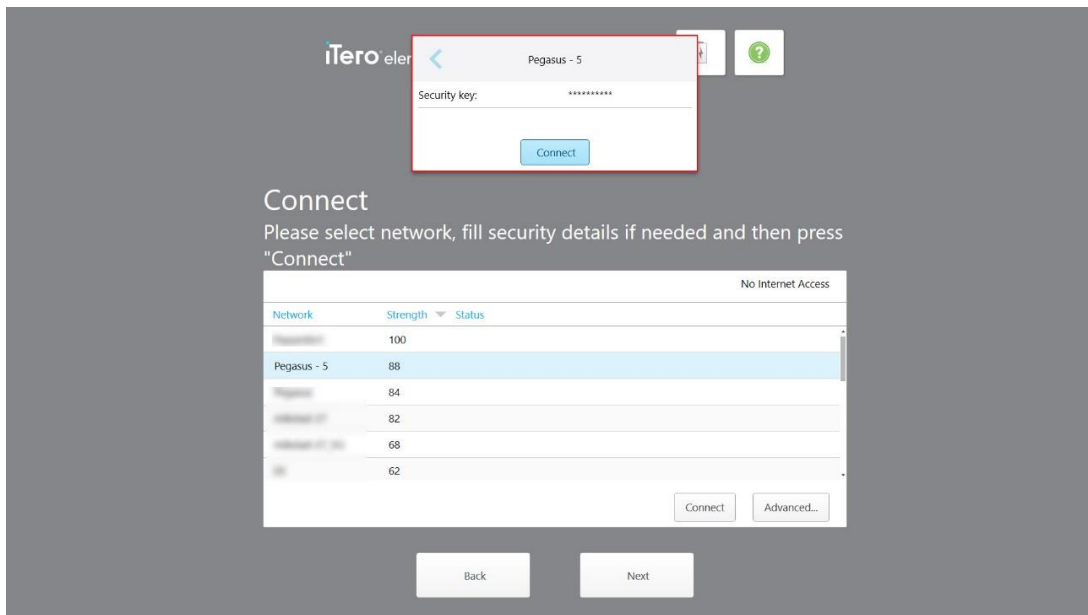

Figure 18: Entering the security key

4. Enter the security key and then tap **Connect**.

The scanner is now connected to the Internet and online.

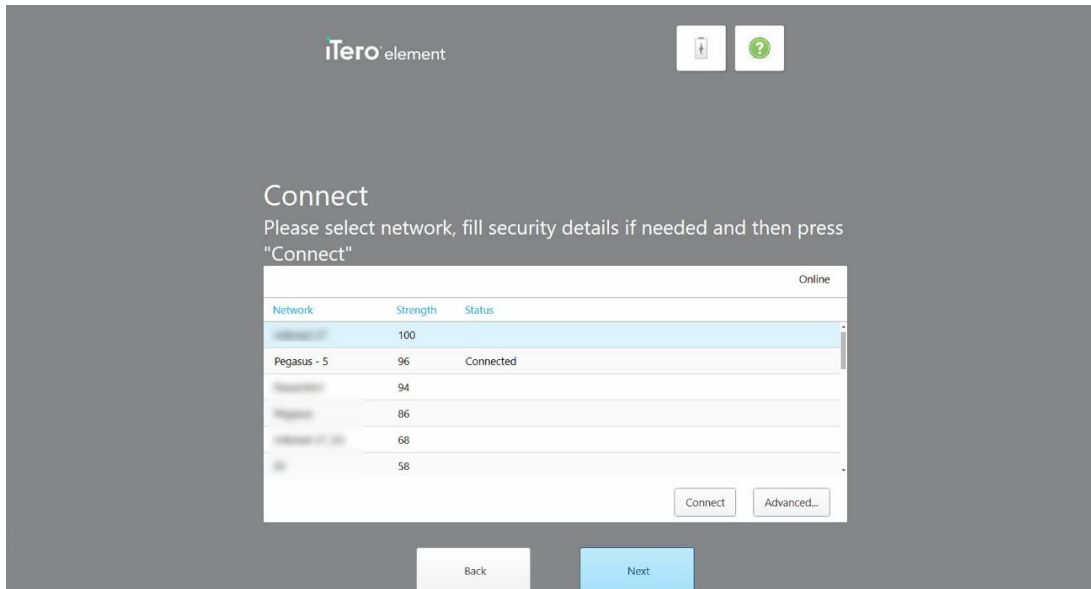

Figure 19: Scanner is connected to the Internet and online

5. Tap **Next**.

The communication with Align is verified.

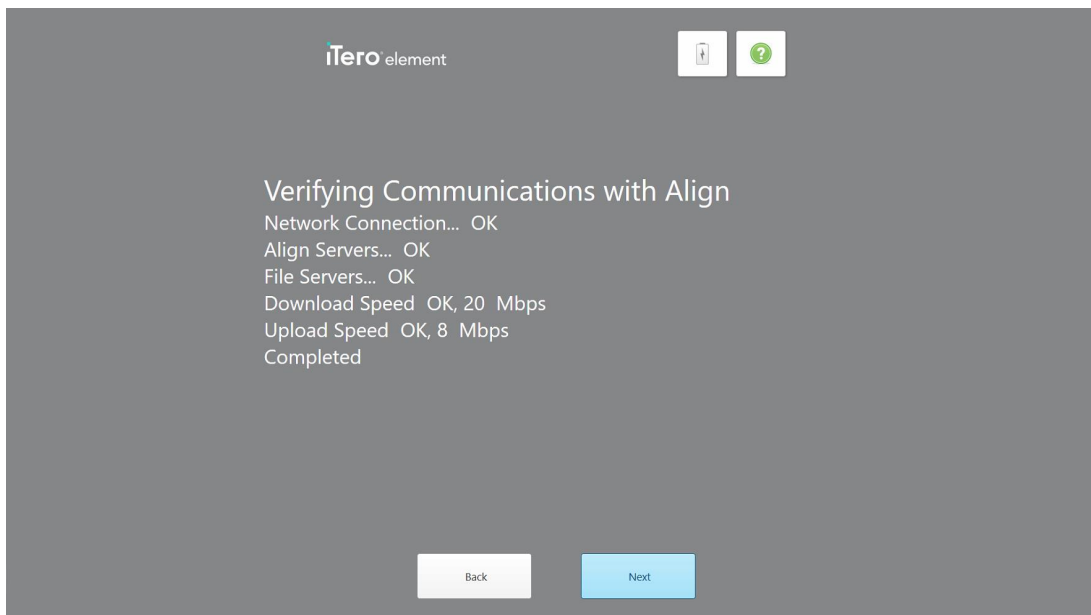

Figure 20: Verifying the communication with Align

- When the verification is complete, tap **Next**.

The *Time Zone* page is displayed.

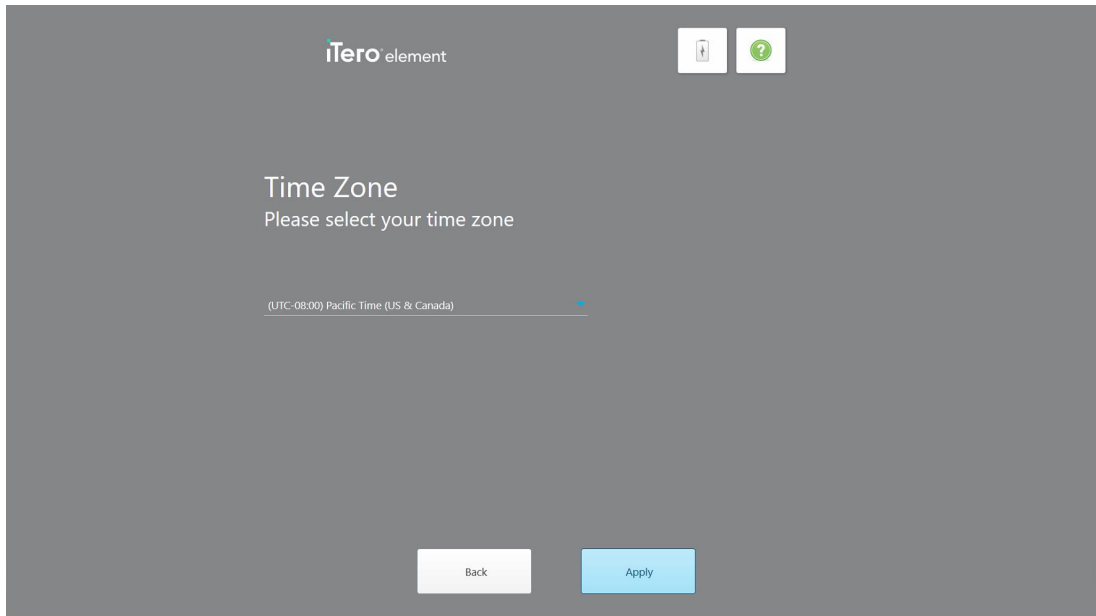

Figure 21: Selecting the time zone

- Tap **Next** if the default time zone is correct or select the time zone from the drop-down list and then tap **Apply**.

The *Register System* page is displayed.

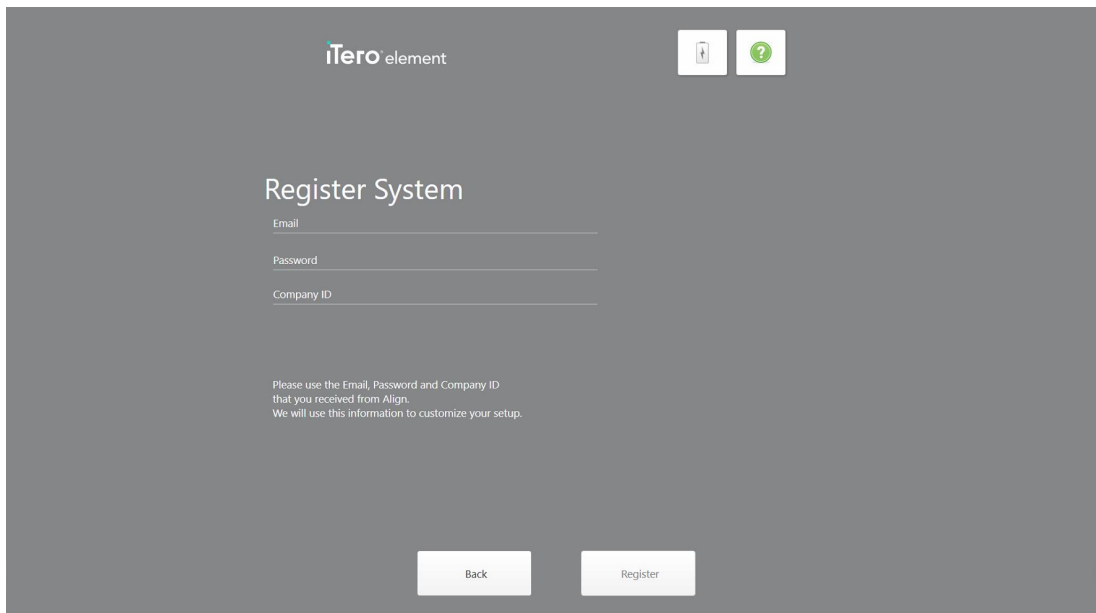

Figure 22: Registering the system to customize the setup

- Enter your email, password, and company ID in the fields provided. Tap **Register** and then tap **Next** after the system has been registered.

The *Scanner Configuration* page is displayed, showing your iTerо subscription package.

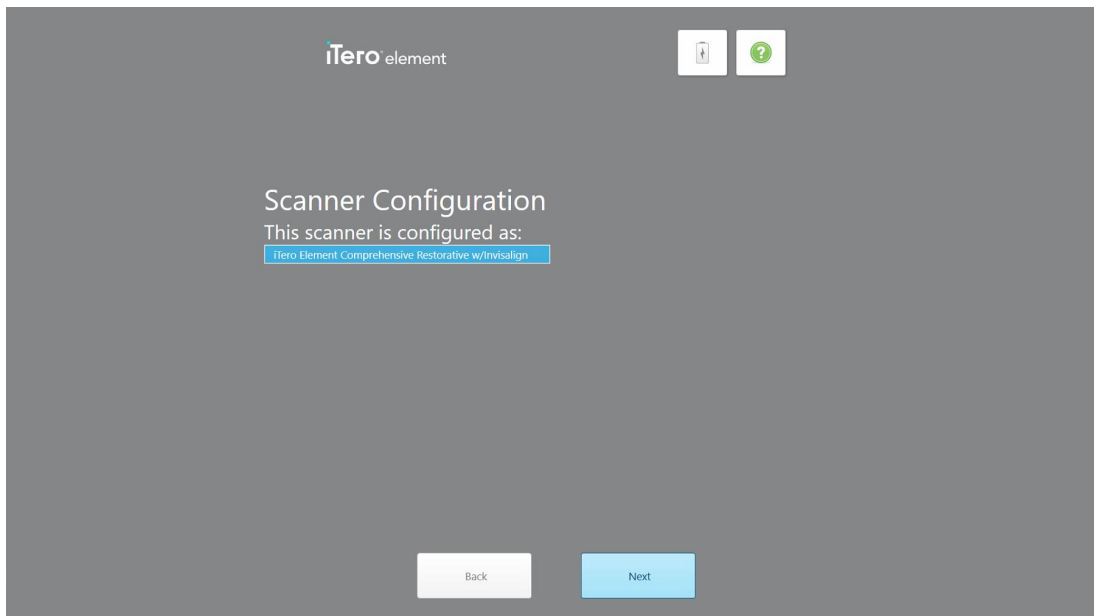

Figure 23: Example of an iTerо subscription package

9. Tap **Next**.

The *License Agreement* page is displayed.

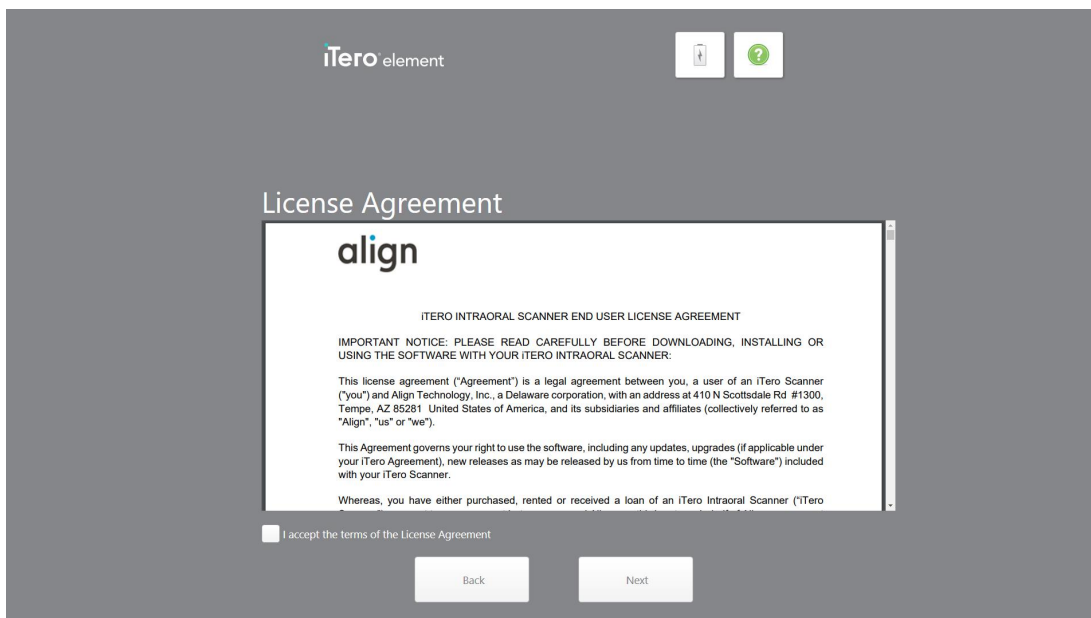

Figure 24: License agreement

10. After reviewing the license agreement, select the check box to accept the terms of the agreement and then tap **Next**.

The system checks for an upgrade and is upgraded to the latest version, if relevant.

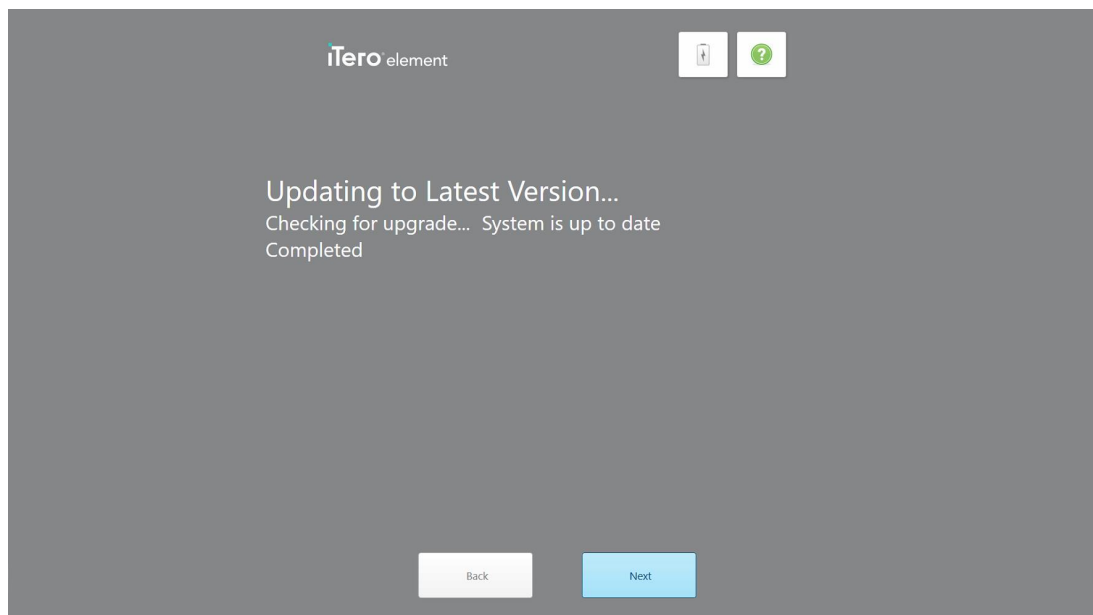

Figure 25: Checking for updates

11. Tap **Next**.

The system has been registered and is ready.

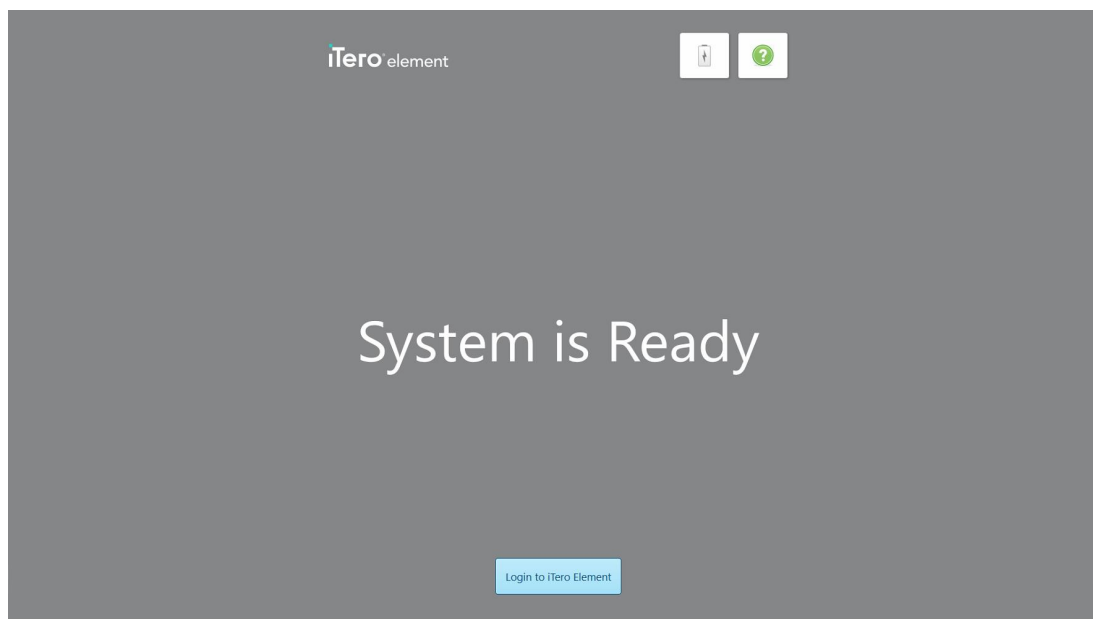

Figure 26: System is registered and ready

12. Tap **Login to iTero Element** to log in to the system.

The *Login* window is displayed. For more details on logging in to the system, see [Logging in to the scanner](#).

4 Working with the scanner

4.1 Logging in to the scanner

When the scanner is powered on, the *Login* window is displayed.

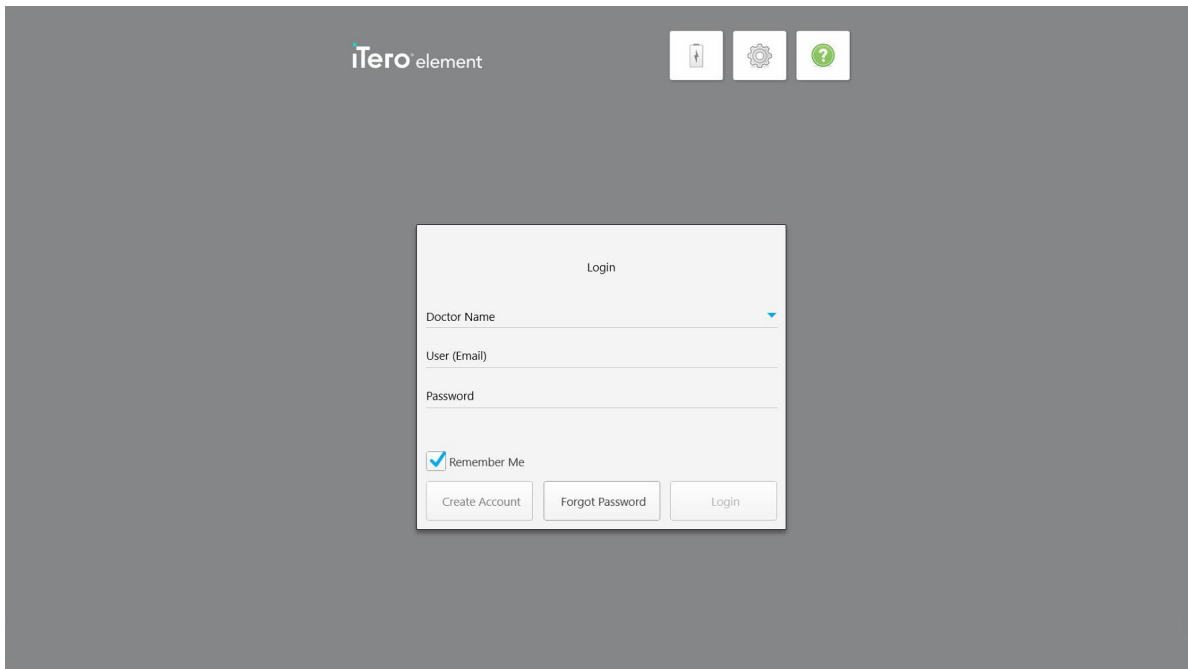

Figure 27: Login window

Make sure you have your MyAligntech account information ready when logging in to the iTero scanner. You need your name, account email, and password. Fill in all the necessary fields and then tap the **Login** button.

Notes:

- **Note:** In order to ensure that all Windows security patches are up-to-date, a notification is displayed as soon as security updates are available for installation. For more information on scheduling the installation of these security updates, see [Installing Windows security updates](#).

- If you did not shut down the scanner correctly previously, a message will be displayed notifying you of this and will remain until you acknowledge the message by tapping **I UNDERSTAND**. For more information on shutting down the scanner, see [Shutting down the scanner](#).

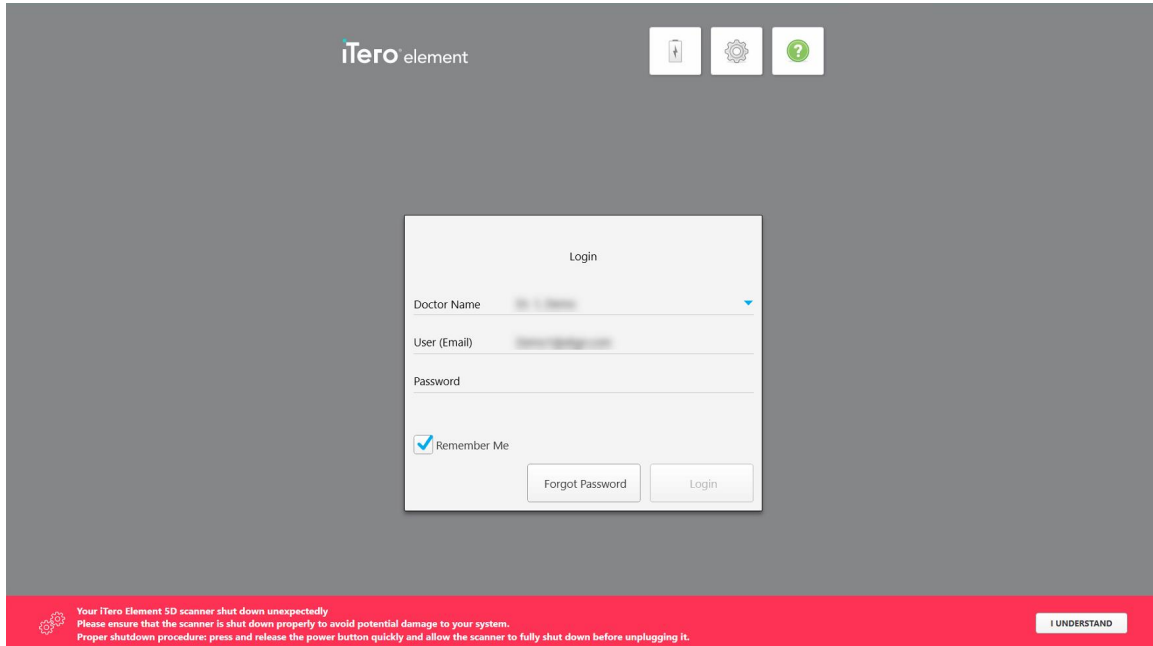
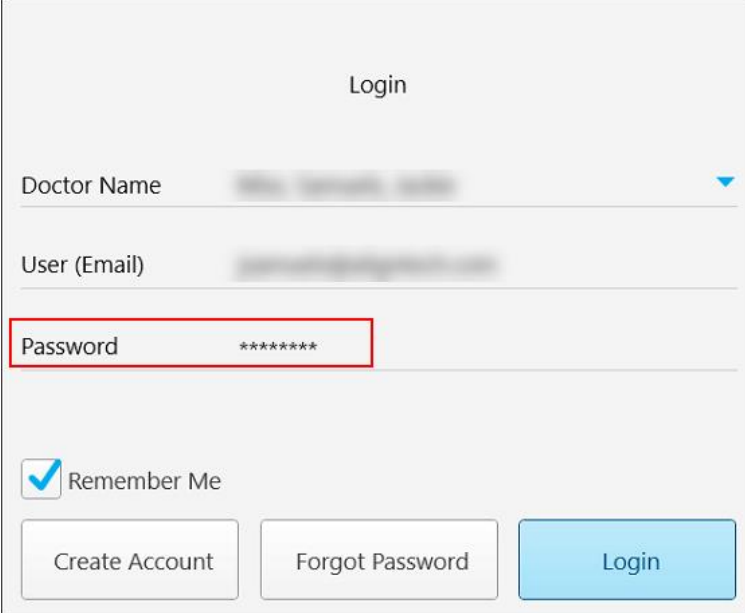

Figure 28: Unexpected shutdown notification

To log in to the scanner:

1. Select your username from the **Doctor Name** drop-down list.
2. Enter the email address you used when registering with myaligntech.com. Your email address is displayed automatically if you selected the **Remember Me** check box in a previous login session.
3. Enter your password.

The text is masked as asterisks.



The screenshot shows a login form titled "Login". It contains three input fields: "Doctor Name" with a dropdown arrow, "User (Email)", and "Password". The "Password" field is highlighted with a red border and contains seven asterisks. Below the fields is a "Remember Me" checkbox which is checked. At the bottom are three buttons: "Create Account", "Forgot Password", and "Login".

Figure 29: Password is masked

If you have forgotten your password, you can reset it, as described in [Resetting your password](#).

4. Select the **Remember Me** check box for the system to remember your email address in future sessions. You will still need to enter your password in order to access the scanner.
5. Tap **Login**.

The iTero home screen is displayed.

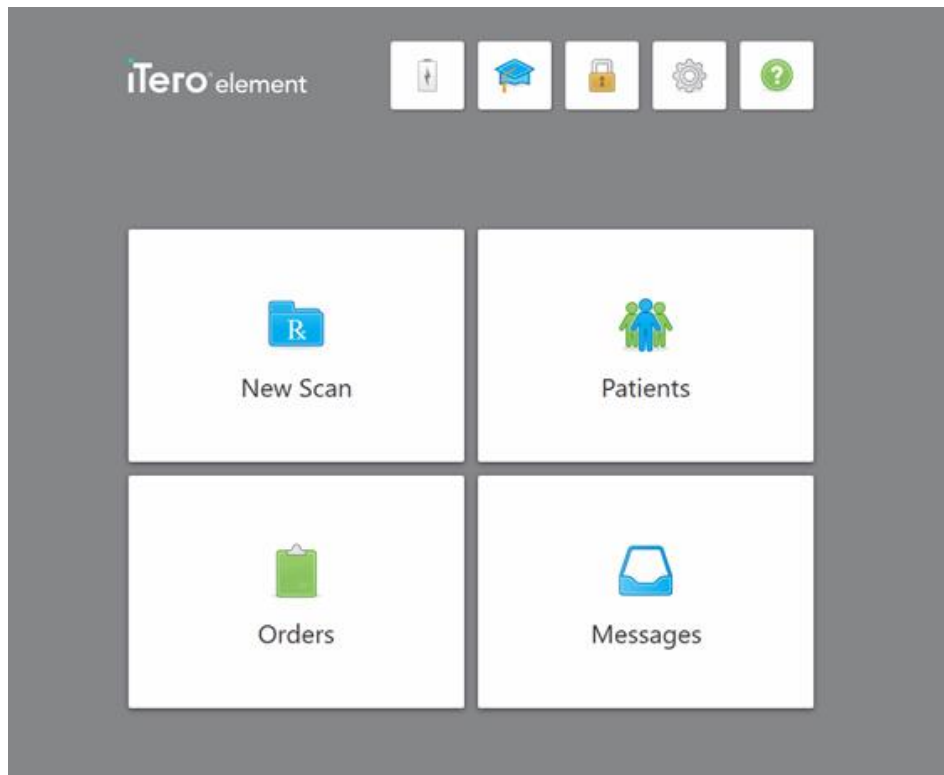

Figure 30: iTero home screen

4.1.1 Resetting your password

You can reset your password, if required.

To reset your password:

1. In the *Login* window, tap **Forgot Password**.

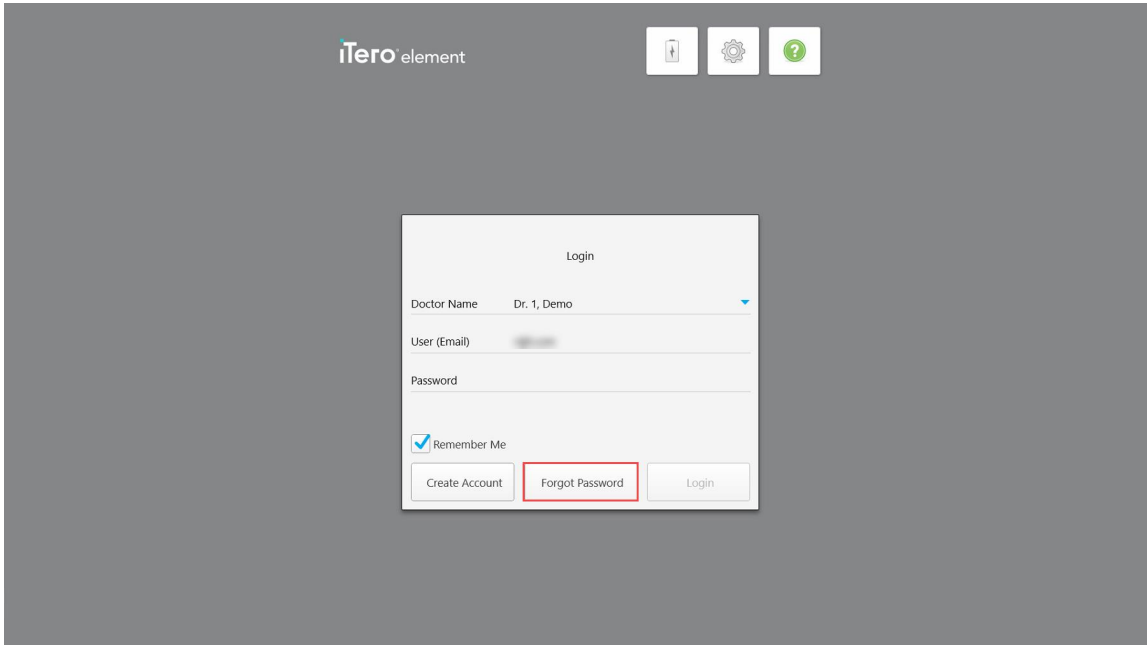

Figure 31: Forgot Password button

A window is displayed, describing what you should do next.

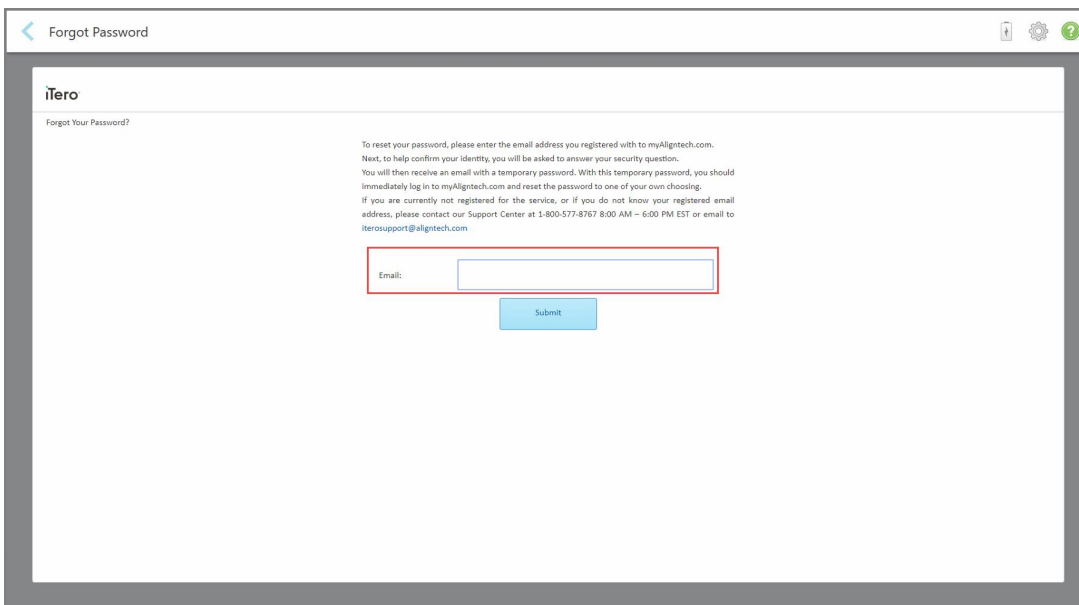
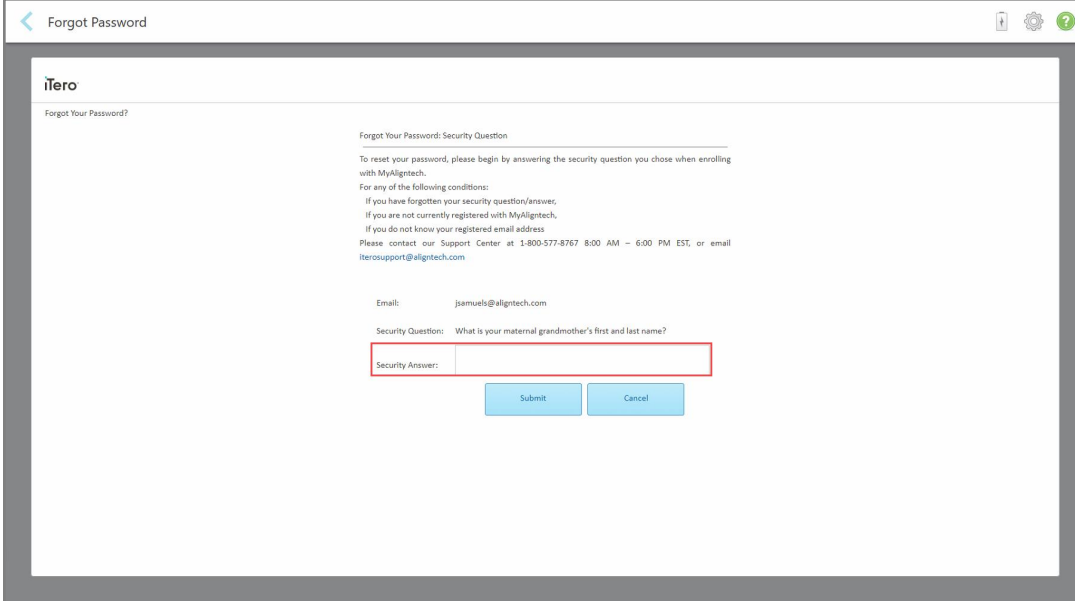

Figure 32: Email field for forgotten password

- In the **Email** field, enter the email address you used to register for myaligntech.com.
- Tap **Submit**.

Your predetermined security question is displayed.



The screenshot shows a mobile application interface for a password reset. At the top, there's a navigation bar with a back arrow and the text 'Forgot Password'. Below this is the iTerо logo and the heading 'Forgot Your Password?'. The main content area contains instructions: 'Forgot Your Password: Security Question', 'To reset your password, please begin by answering the security question you chose when enrolling with MyAlignTech.', and 'For any of the following conditions: If you have forgotten your security question/answer, If you are not currently registered with MyAlignTech, If you do not know your registered email address'. It then displays the email 'jsamuels@aligntech.com' and the security question: 'Security Question: What is your maternal grandmother's first and last name?'. Below the question is a text input field for the 'Security Answer:', which is highlighted with a red border. At the bottom, there are two buttons: 'Submit' and 'Cancel'.

Figure 33: Security answer field

- Enter the answer to the security question.
A temporary password will be sent to you.
- Use the temporary password to log in to myaligntech.com and then reset your password, according to the iTerо password policy described in [iTerо password policy](#).
- If you do not know your registered email address, contact iTerо Customer Support.

4.1.1.1 iTerо password policy

When changing your password, ensure that your new password meets the following criteria:

- At least eight characters in length
- No spaces
- At least one upper-case letter
- At least one lower-case letter
- At least one number
- Optional: Passwords may include special characters (for example: !, #, \$, %, ^)

4.1.2 Installing Windows security updates

In order to support the continuous cyber security of the scanner, whenever the iTero software is upgraded, any relevant Windows security updates are downloaded to the scanner and must be installed *within 7 days*.

After the Windows security updates have been downloaded, a *Security Updates* window is displayed when logging in to the scanner, notifying you about these upgrades and enabling you to schedule a time the updates should be installed – postponed daily for up to 7 days, immediately, or later the same night.

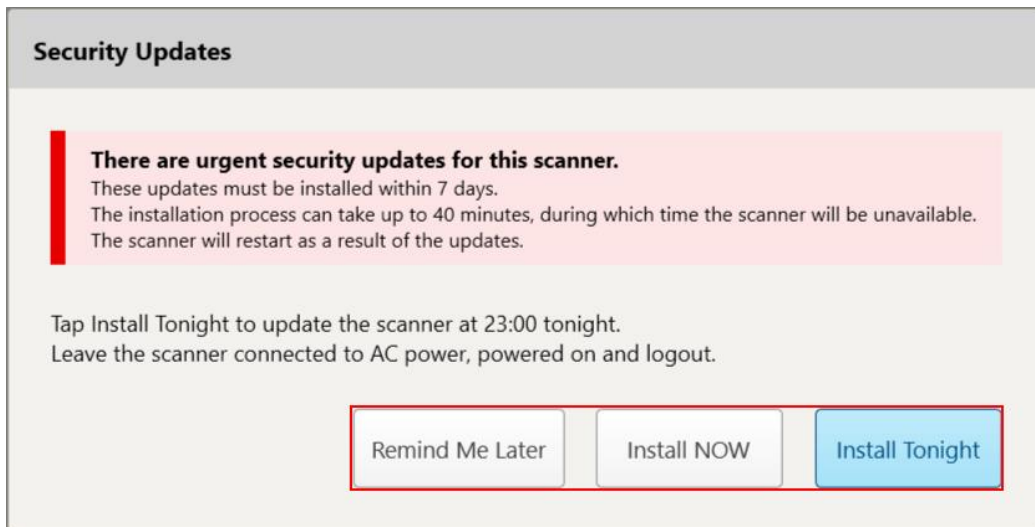

Figure 34: Security Updates window - scheduling options

To install the security updates, the scanner needs to be connected to the AC power and switched on, and you need to log out.

Notes:

- Installing the updates should take about 40 minutes, during which time the scanner cannot be used.
- Once the installation starts, it cannot be paused or canceled.
- If you ignore the message and do not install the updates within 7 days, they will be installed automatically the next time the scanner is restarted.

To schedule the security-update installation:

1. In the *Security Updates* window, tap one of the following scheduling options:
 - **Remind Me Later:** The installation will be postponed for up to 7 days. For more information, see [Remind Me Later – Postponing the software update installation](#).
 - **Install NOW:** The software updates are installed immediately.
 - **Install Tonight:** The software updates will be installed at 11 PM that night. For more information, see [Install Tonight – Installing the security updates later that night](#).
2. Before the installation is due to take place, make sure that the scanner is connected to the AC power and switched on, and that you have logged out.

If the scanner is not connected to the AC power, you will be prompted to connect it.



Figure 35: Connect the scanner to the AC power

- Plug in the scanner and then tap **Continue**.

The installation starts and a message is displayed showing the installation progress.

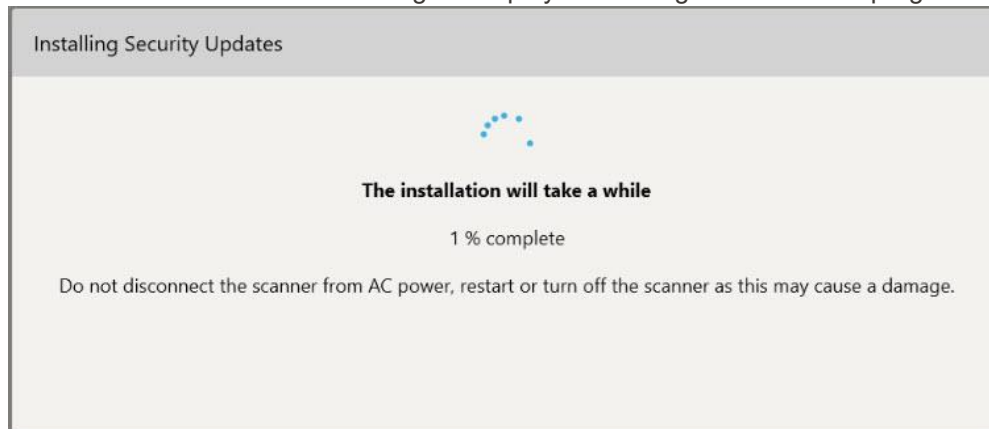

Figure 36: Installation in progress

Note: Do not unplug, restart, or turn off the scanner while the security updates are being installed.

Once the security updates have been installed, a success notification is displayed and the scanner restarts.

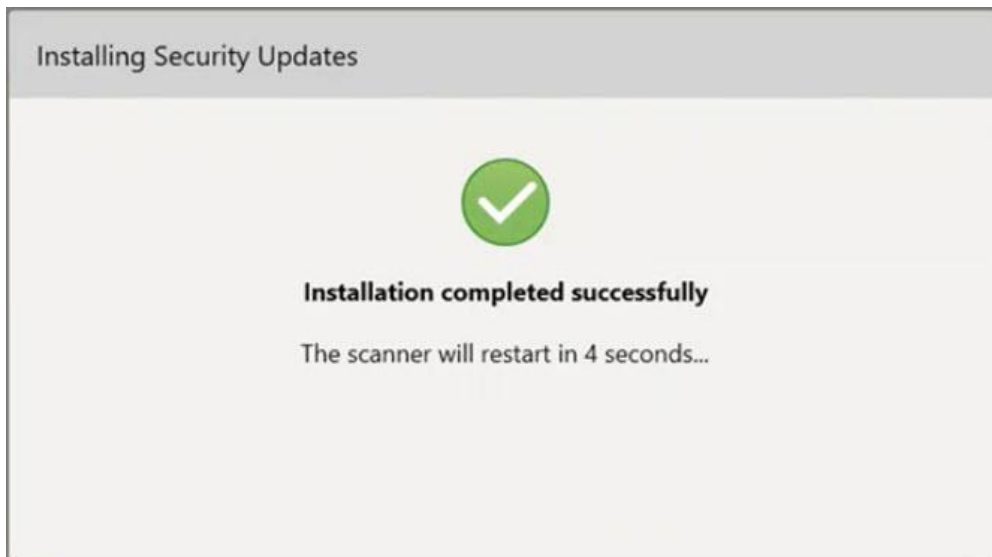

Figure 37: Installation completed successfully

4.1.2.1 Remind Me Later – Postponing the software update installation

You can postpone the security-update installation for up to a week. Every day, the notification will display the number of days remaining until the security updates have to be installed. You can select to postpone the updates, install them immediately, or schedule them for later that night.

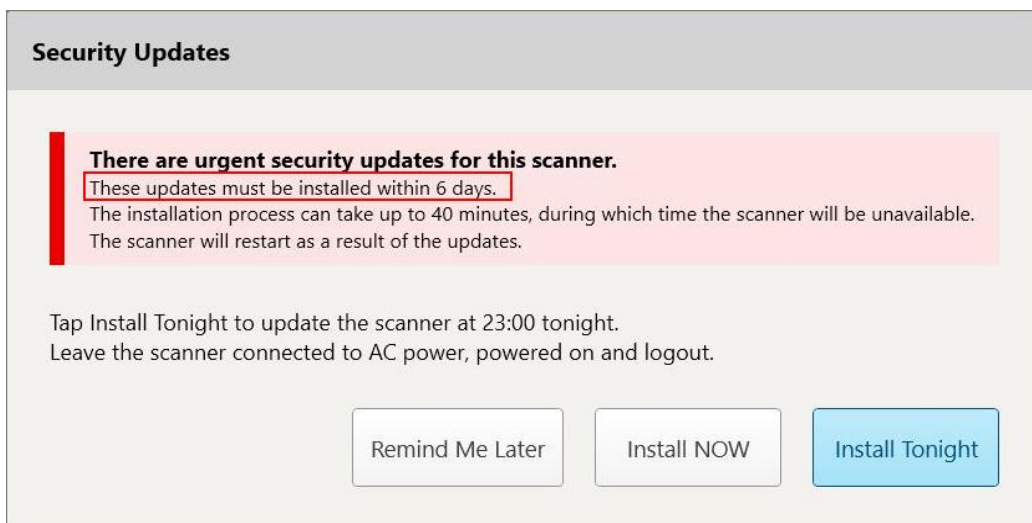

Figure 38: Security updates – number of days until the updates must be installed

On the 7th day, the security updates must be installed. You can select whether to install them immediately, or schedule the installation for later that night, as described below.

Note: If you ignore the message and do not install the updates, they will be installed automatically the next time the scanner is restarted.

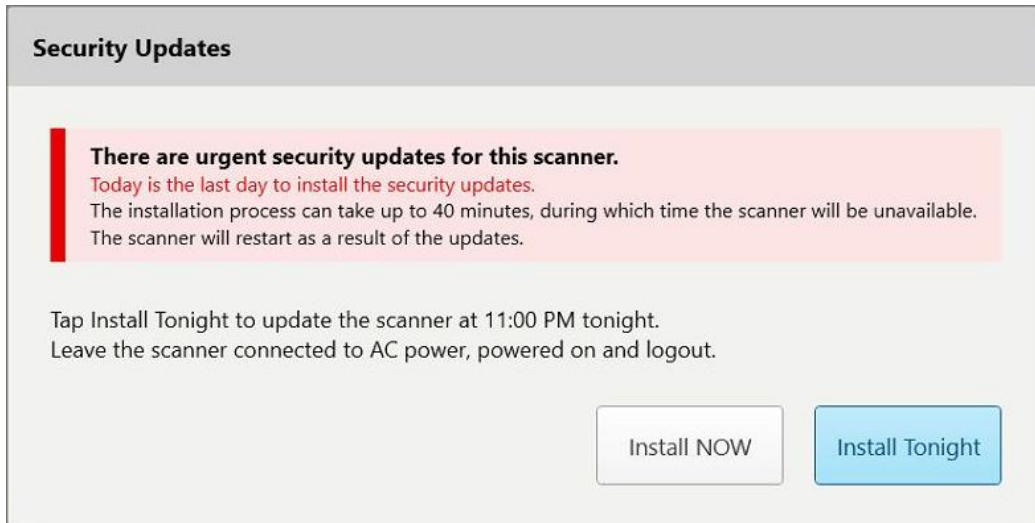
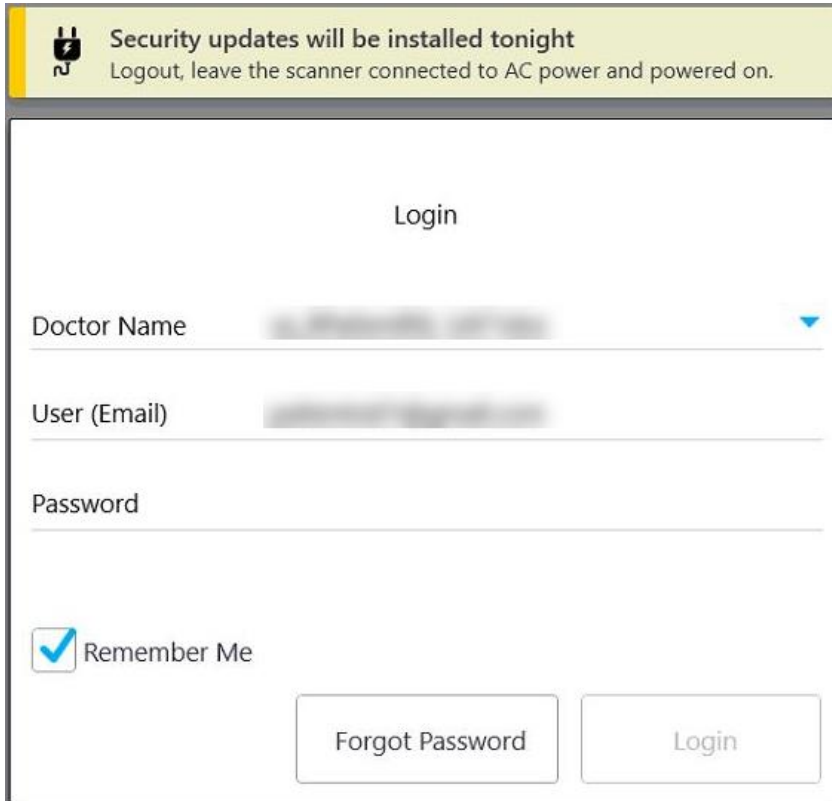

Figure 39: Security updates – last day

4.1.2.2 Install Tonight – Installing the security updates later that night

If you select to install the security updates later that night, a banner is displayed above the scanner *Login* window and the home screen reminding you that the scanner needs to be connected to the AC power and switched on, and that you need to log out.



The screenshot shows a notification banner at the top with a yellow background and a plug icon. The banner text reads: "Security updates will be installed tonight" followed by "Logout, leave the scanner connected to AC power and powered on." Below the banner is the "Login" window. The window has a title "Login" and three input fields: "Doctor Name" (with a dropdown arrow), "User (Email)", and "Password". There is a "Remember Me" checkbox with a blue checkmark. At the bottom, there are two buttons: "Forgot Password" and "Login".

Figure 40: Security updates notification – Login window

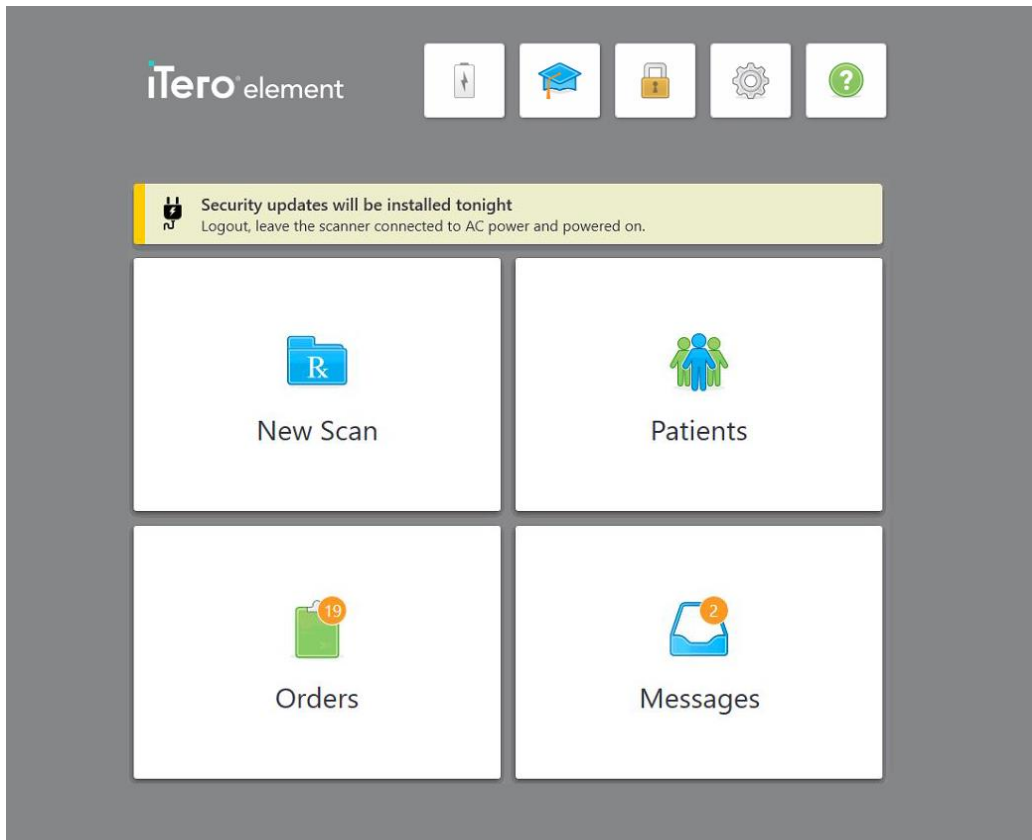



Figure 41: Security updates notification – home screen

4.2 Logging out of the scanner

In order to protect the patient information, you should log out of the scanner when it is not in use. Your password will *not* be remembered by the system.

By default, you will be logged out after a predefined period of inactivity, which can be defined in the **Login** settings, described in [Defining the login settings](#).

To log out of the scanner:

1. Tap  to return to the home screen.

2. Tap  to log out of the system.

The *Login* window is displayed, ready for the next user to log in to the system.

4.3 Shutting down the scanner

It is recommended to shut down the system at the end of each day to allow software updates to be installed.

Note: If you do not shut down the scanner correctly, the next time you log on, a message will be displayed notifying you of this and will remain until you acknowledge it. Incorrect shutdown can be caused by letting the battery run down and by pressing the Power button for longer than 4 seconds.

To shut down the scanner:

- Press and release the Power button to shut down the system. The Power button is located on the bottom right of the screen in iTero Element 2 systems and on the top right of the screen in iTero Element 2 Plus systems.

Warning: Pressing the button for more than 4 seconds activates a hard reset, which can cause problems such as gray and blue screens.

4.4 Moving the scanner

4.4.1 Moving the iTero Element 2 wheel-stand configuration scanner

The scanner can be moved between rooms within the office.

Note: To ensure maximum system protection, it is recommended to have 2 people move the scanner.

To move the scanner between rooms:

1. Ensure that the wand is firmly positioned in the cradle.
2. Unplug the system from the wall outlet.
3. Move the system to its new location and plug it into a wall outlet.

4.4.2 Transporting the iTero Element Flex intraoral scanner

To ensure maximum system protection, it is recommended to follow the instructions below when transporting the system:

1. Attach the blue protective sleeve onto the wand.

2. Place all items in the supplied carrying case to move the system between offices.



Figure 42: iTero Element Flex intraoral scanner in the supplied carrying case

3. Make sure the case is kept dry to protect the system components from humidity.

4.4.3 Moving the iTero Element 2 Plus cart-configuration scanner

The scanner can be moved between rooms within the office and while you are seated, with a patient.

To move the scanner between rooms:

1. Ensure that the wand is firmly positioned in the cradle.
2. Unplug the system from the wall outlet and carefully wrap the power cable around the upper handle, to prevent the cable from being caught between the wheels.
3. Using the upper handle, move the system to its new location and plug it into a wall outlet.

Note: If the scanner needs to be lifted, lift it using the upper handle and the post.

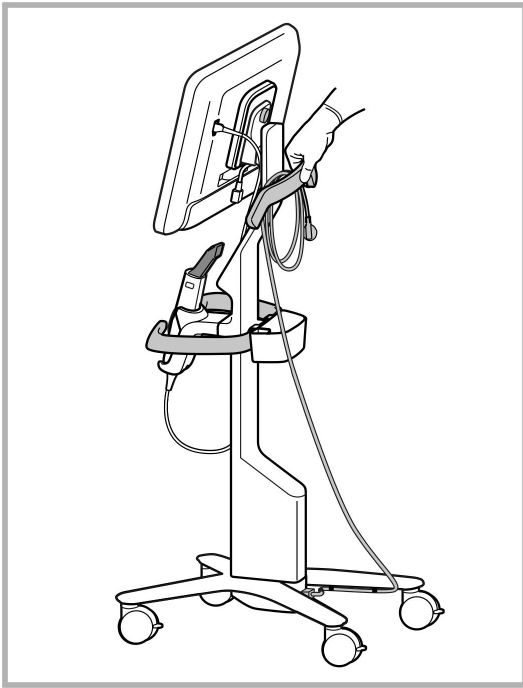

Figure 43: Moving the scanner

To move the cart-configuration scanner while in a seated position:

- Use the main handle to move the scanner.
- The screen height is optimized for a more ergonomic experience while seated. If required, you can adjust the tilt of the screen.

Note: Do not use the wand or the wand cable to move the scanner, in order to prevent the scanner from toppling over or damage to the cable.

4.4.4 Carrying the iTero Element 2 Plus mobile-configuration scanner within the clinic

The mobile-configuration scanner can be carried between rooms within the clinic as well as transported between clinics.

When carrying the scanner, you should always move the handle to the carrying position and wind the wand cable around the cradle.

To carry the mobile-configuration scanner within the clinic:

1. Ensure that the wand is firmly positioned in the cradle.
2. Disconnect the power cable from the mains and then from the back of the computing unit.
3. While holding the computing unit with one hand, slide the locking latch to unlock the handle and then move the handle to the carrying position. For more information, see [Moving the scanner within the clinic](#).

4. Loosely wrap the cable around the cradle for easy and safe portability.

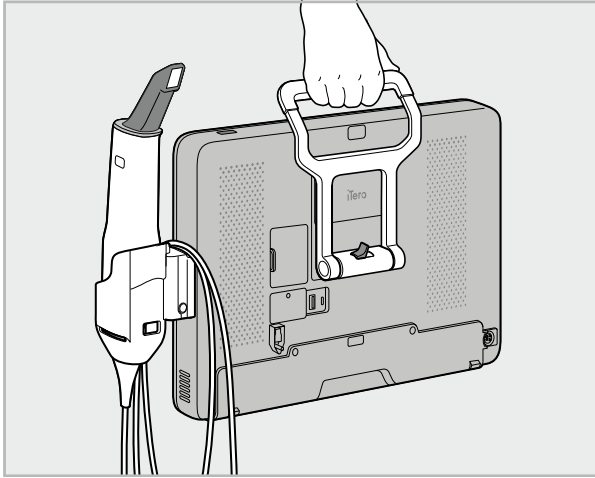

Figure 44: Carrying the scanner between rooms within the clinic

4.4.5 Transporting the iTerio Element 2 Plus mobile-configuration scanner between clinics

When transporting the mobile-configuration scanner between clinics, always pack the scanner in its supplied trolley. For more details, see [Using the trolley for transportation](#).

To transport the scanner between clinics:

1. Turn off the scanner.
2. Disconnect the power cable from the mains and then from the back of the computing unit.
3. Disconnect the scanner components and pack them in their designated compartments in the trolley. For more information, see [Using the trolley for transportation](#).
4. Close and secure the trolley flap and then close the trolley by lifting the side with the fastened flap and zipping it closed.



Figure 45: Transporting the scanner between clinics

- If required, use the optional protective cover to protect the trolley against wear and tear and adverse weather conditions. For more information, see [Optional protective trolley cover](#).

4.5 User interface

The iTero system provides an intuitive user interface for performing digital scans for Restorative or Orthodontic use. The touch screen and wand buttons are used to respond to screen instructions during the scanning process.

For a list of the touch-screen gestures that can be used, see [Touch-screen gestures](#).

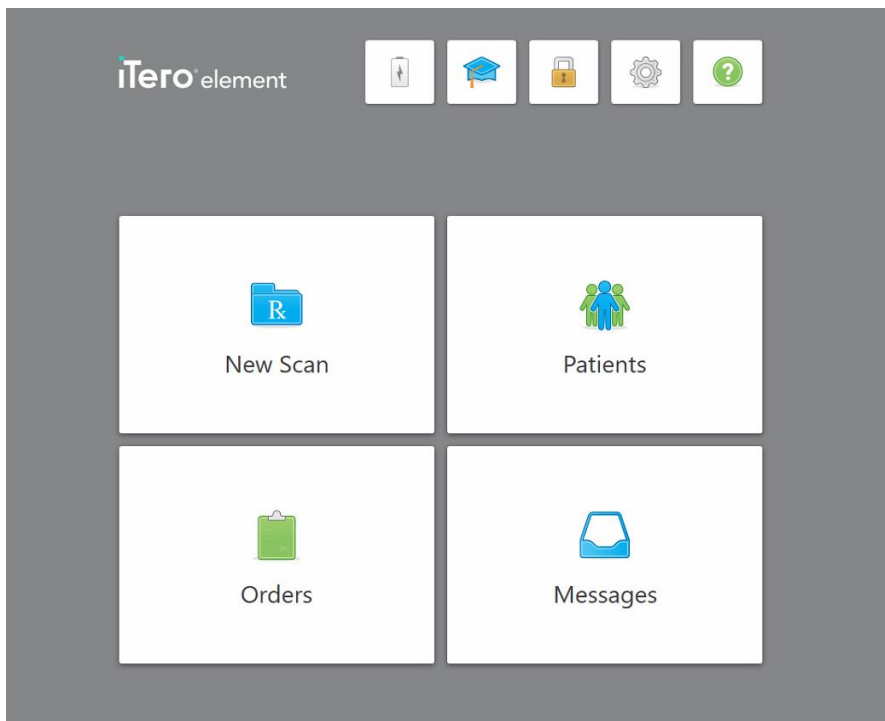

Figure 46: iTero home screen

The following buttons are displayed on the home screen:



Displays the status of the external battery:

- A lightning bolt indicates that the scanner is connected to the power, and the battery is charging.
- When using battery power, the remaining charge level is displayed on the battery icon. When the remaining charge level falls below 25%, the battery

icon is displayed in red.



- Tap the battery icon to view the percentage of remaining charge:

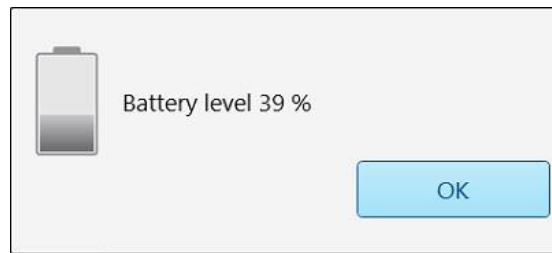

Figure 47: Percentage of remaining battery charge



Learning Center: Tap to access training materials and educational videos for the iTerio scanner.



Lock: Tap to log out of your account whenever the scanner is not in use, as described in [Logging out of the scanner](#). This helps ensure that the dental practice is HIPAA compliant, and that all medical information is secure.

Tip: You should lock the system while cleaning it, in order to avoid unintended entries.



Settings: Tap to adjust the scanner preferences, for example, for wand configuration, localization, user settings, and more. For more information, see [Defining the scanner settings](#).



Help: Tap to display a translucent Help overlay with hints to aid in the navigation of features and tools.

In this view, the **Help** button changes to two new buttons – e-manual and Customer Support:

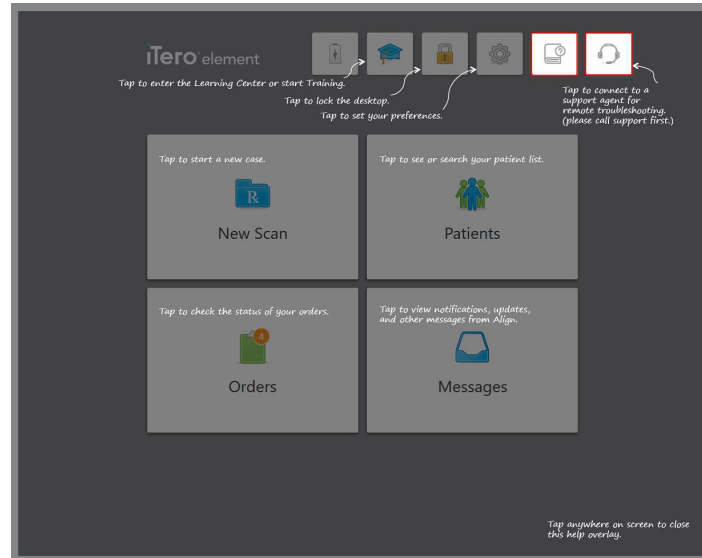

Figure 48: Help overlay including the e-manual and Customer Support buttons



Tap to access the relevant e-manual.



Tap for remote assistance from Customer Support. Customer Support is available from every Help overlay.

Note: Please call Customer Support before trying to connect remotely.

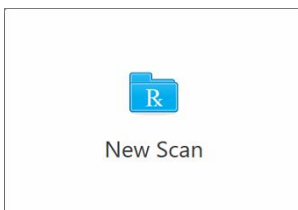

New Scan: Tap to open the *New Scan* window to fill in the Rx before starting a new scan. For more information, see [Starting a new scan](#).



Patients: Tap to view the *Patients* page with a list of all patients registered in your iTero system, and if relevant, their chart number, date of birth, and the date of their last scan. For more information, see [Working with patients](#).

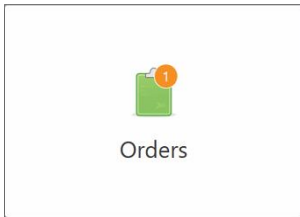

Orders: Tap to display a list of all your orders. For more information, see [Working with orders](#).

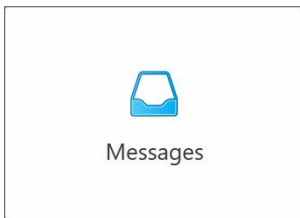

Messages: Tap to view the messages from Align Technology. For more information, see [Viewing messages](#).

The **Battery** and **Settings** buttons are displayed on each of the scanner windows as well, as described in [Scanner toolbar](#).

4.5.1 Scanner toolbar

The following toolbar is displayed on the top of each of the scanner windows:



Figure 49: Scanner toolbar

The 4 center buttons indicate the status of the scan process. Tap the buttons to navigate through the scan flow.



Tap to return to the home screen.

New Scan

Displays the current stage in the scanning process, also indicated by the relevant highlighted button in the toolbar.



Tap to return to the *New Scan* window to view the Rx, as described in [Filling in the Rx](#).



Tap to move to Scan mode to scan the patient, as described in [Scanning the patient](#).



Tap to move to View mode to view the scanned model, as described in [Viewing the scan](#).



Tap to send the scanned model to the lab or your chairside milling software, as described in [Sending the scan](#).



Displays the status of the external battery:

- A lightning bolt indicates that the scanner is connected to the power, and the battery is charging.
- When using battery power, the remaining charge level is displayed on the battery icon. When the remaining charge level falls below 25%, the battery icon is displayed

in red .

- Tap the battery icon to view the percentage of the remaining charge:

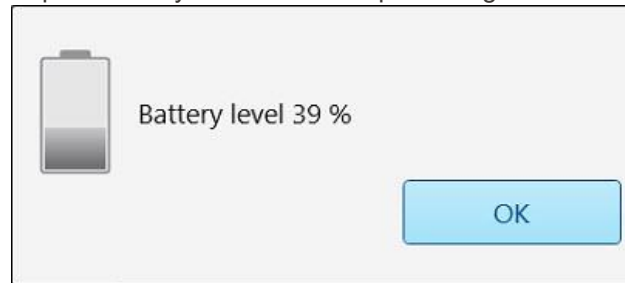

Figure 50: Percentage of remaining battery charge



Tap to adjust the scanner preferences, for example, for wand configuration, localization, user settings, and more.

For more information on the Settings preferences, see [Defining the scanner settings](#).



Tap to display a translucent Help overlay with hints to aid in the navigation of features and tools.

In this view, the **Help** button changes to two new buttons – e-manual and Customer Support:

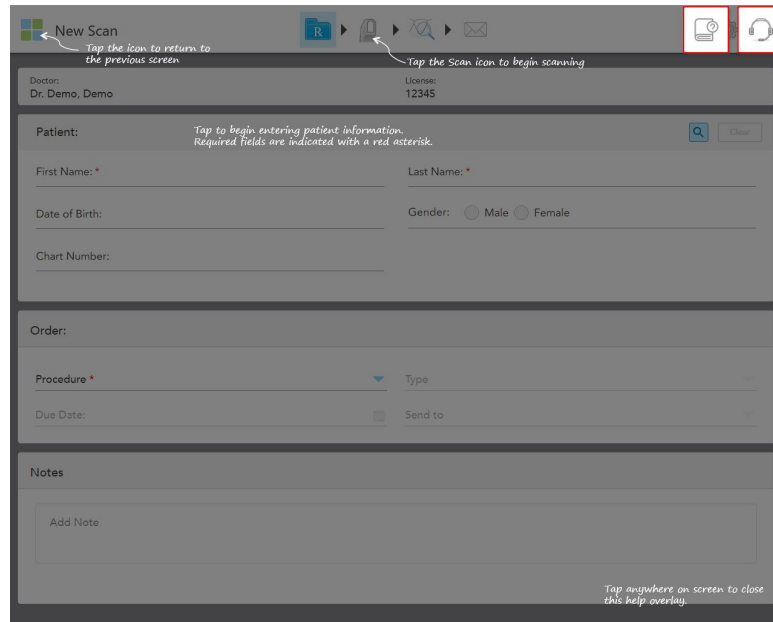

Figure 51: Help overlay including e-manual and Customer Support buttons



Tap to access the relevant e-manual.



Tap for remote assistance from Customer Support. Customer Support is available from every Help overlay.

Note: Please call Customer Support before trying to connect remotely.

4.5.2 Touch-screen gestures

The iTero software supports touch-screen (also known as multi-touch) gestures. These gestures are predefined motions used to interact with multi-touch devices.

Examples of common touch-screen gestures:



Tap



Double tap



Long press



Scroll



Rotate



Swipe



Pan



Zoom out



Zoom in

4.6 Defining the scanner settings

The scanner settings enable you to define your preferences and the settings that are displayed by default when you use the scanner.

To define the scanner settings:

1. Tap the  button.

The *Settings* window is displayed.

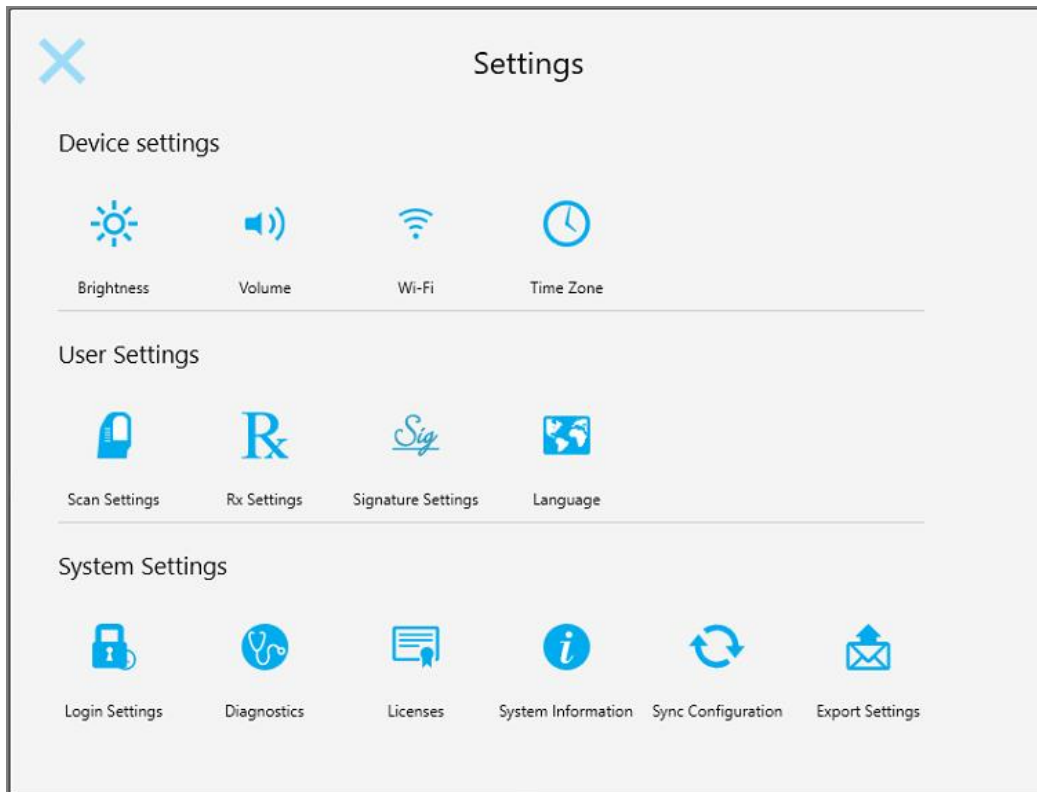

Figure 52: Settings window

2. Tap the settings you would like to define.
 - [Defining the Device settings](#)
 - [Defining the User settings](#)
 - [Defining the System settings](#)

The relevant window opens.

3. Make your required changes and then tap  to save the changes and return to the *Settings* window.

4.6.1 Defining the Device settings

The Device settings enable you to define the brightness, volume, Wi-Fi, and time-zone settings for the scanner.

4.6.1.1 Defining the default brightness setting

To define the default brightness setting, tap the **Brightness** button, move the slider to the required brightness level, and then tap  to save the changes and return to the *Settings* window.



Figure 53: Brightness settings

4.6.1.2 Defining the default volume setting

To define the default system volume, tap the **Volume** button, move the slider to the required volume level, and then tap  to save the changes and return to the *Settings* window.



Figure 54: Volume settings

In addition to the system sounds, the volume settings define the volume for the content from the Learning

Center .

4.6.1.3 Defining the Wi-Fi settings

The first time you connect the scanner to the clinic's Wi-Fi network, you will need to add the password. After that, by default, the scanner will connect automatically. If you want to connect to a different Wi-Fi network, select the new network and enter the relevant password.

To reconnect to a Wi-Fi network:

1. Tap the **Wi-Fi** button.

A list of nearby Wi-Fi networks is displayed.



Figure 55: List of nearby Wi-Fi networks

2. Select the clinic network, for example, Pegasus - 5, and then tap **Connect**.

3. Enter the network security key (password) in the window that opens and then tap **Connect**.

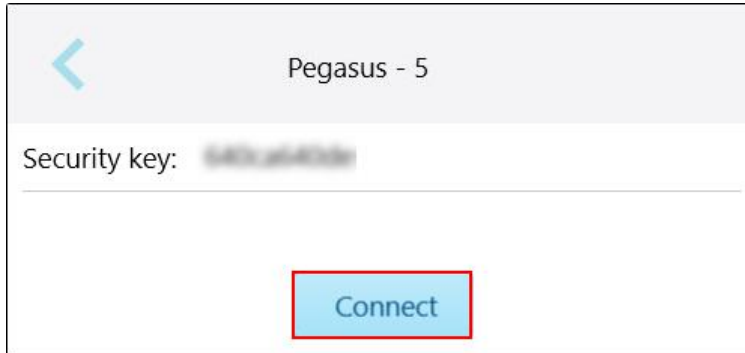

Figure 56: Connecting to the clinic Wi-Fi network

The scanner connects to the Wi-Fi network, and the status changes to **Connected**.

4. If you do not want to connect to the network automatically, tap the network you are connected to and then tap **Forget**.

You will need to select the required network and enter the Wi-Fi password the next time you want to connect.

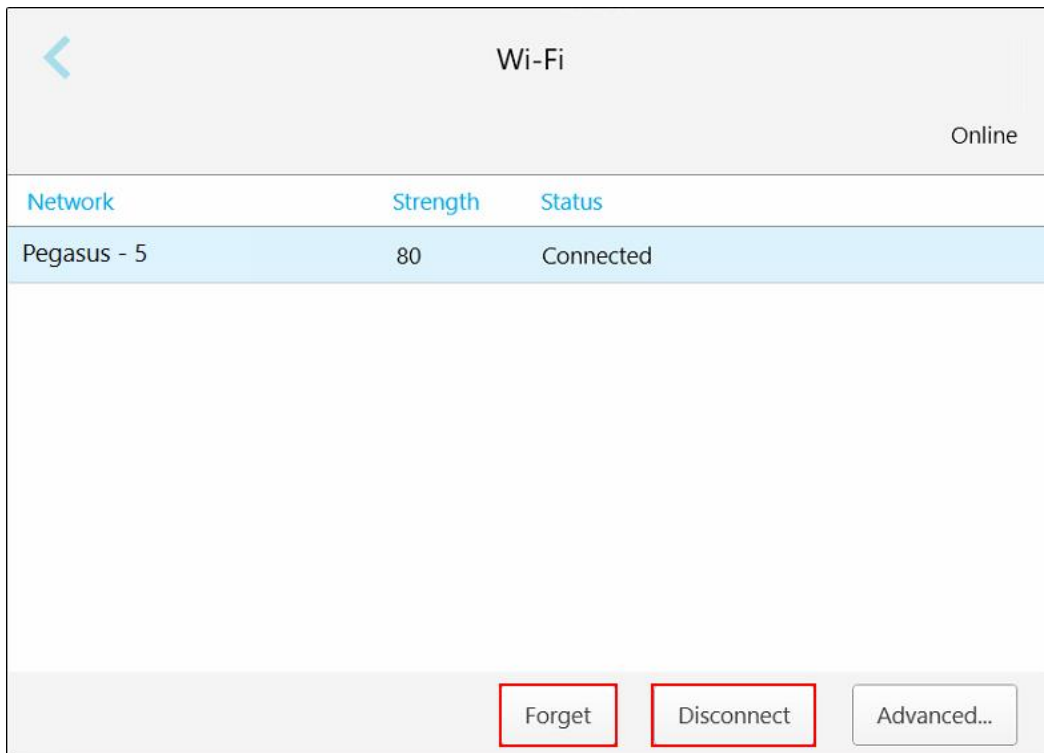



Figure 57: Forgetting or Disconnecting from the network

5. To disconnect from the network, tap **Disconnect**.
6. Tap  to save the settings and return to the *Settings* window.

4.6.1.4 Defining the time zone

To define the time zone, tap the **Time Zone** button, select the time zone from the drop-down list, and then tap  to save the changes and return to the *Settings* window.

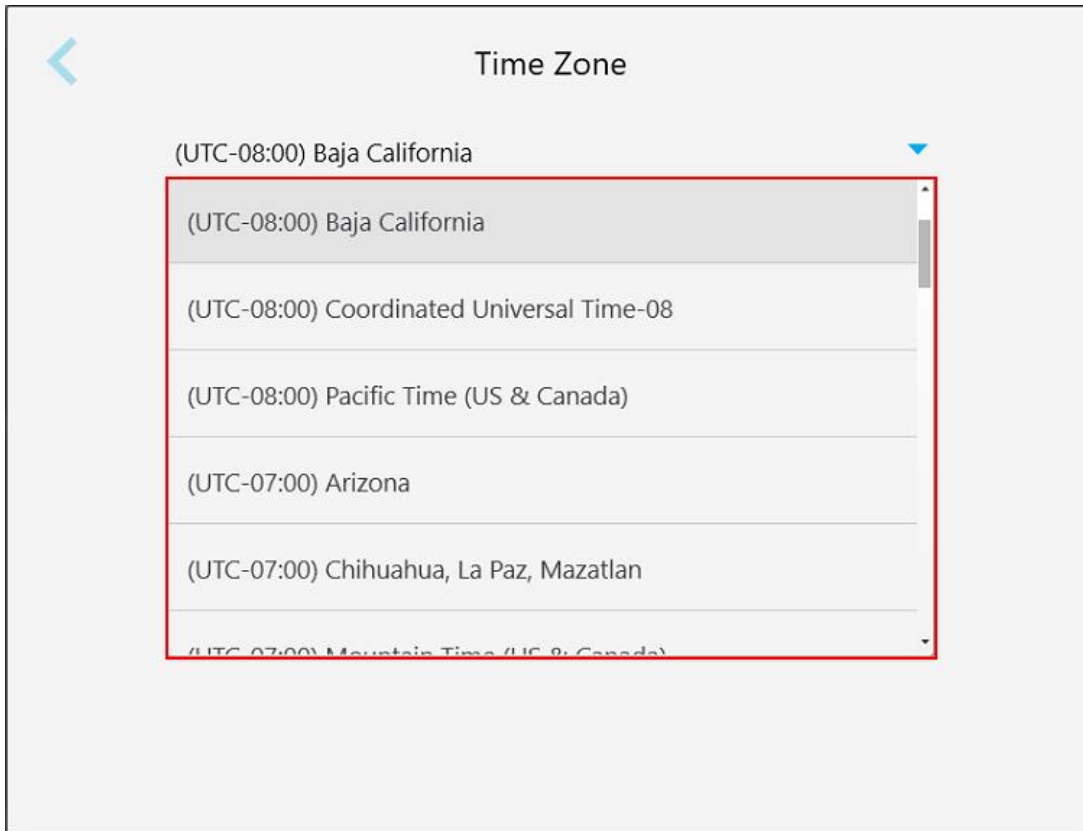

Figure 58: Time zone settings

Note: The time zone settings can be accessed only when you are logged in to the scanner.

4.6.2 Defining the User settings

The User settings enable each user to define the settings that are displayed by default when the specific user logs in to the scanner.

4.6.2.1 Defining the scan settings

You can define the default settings that are taken into account when scanning a patient.

To define the scan settings:

1. Tap the **Scan Settings** button.

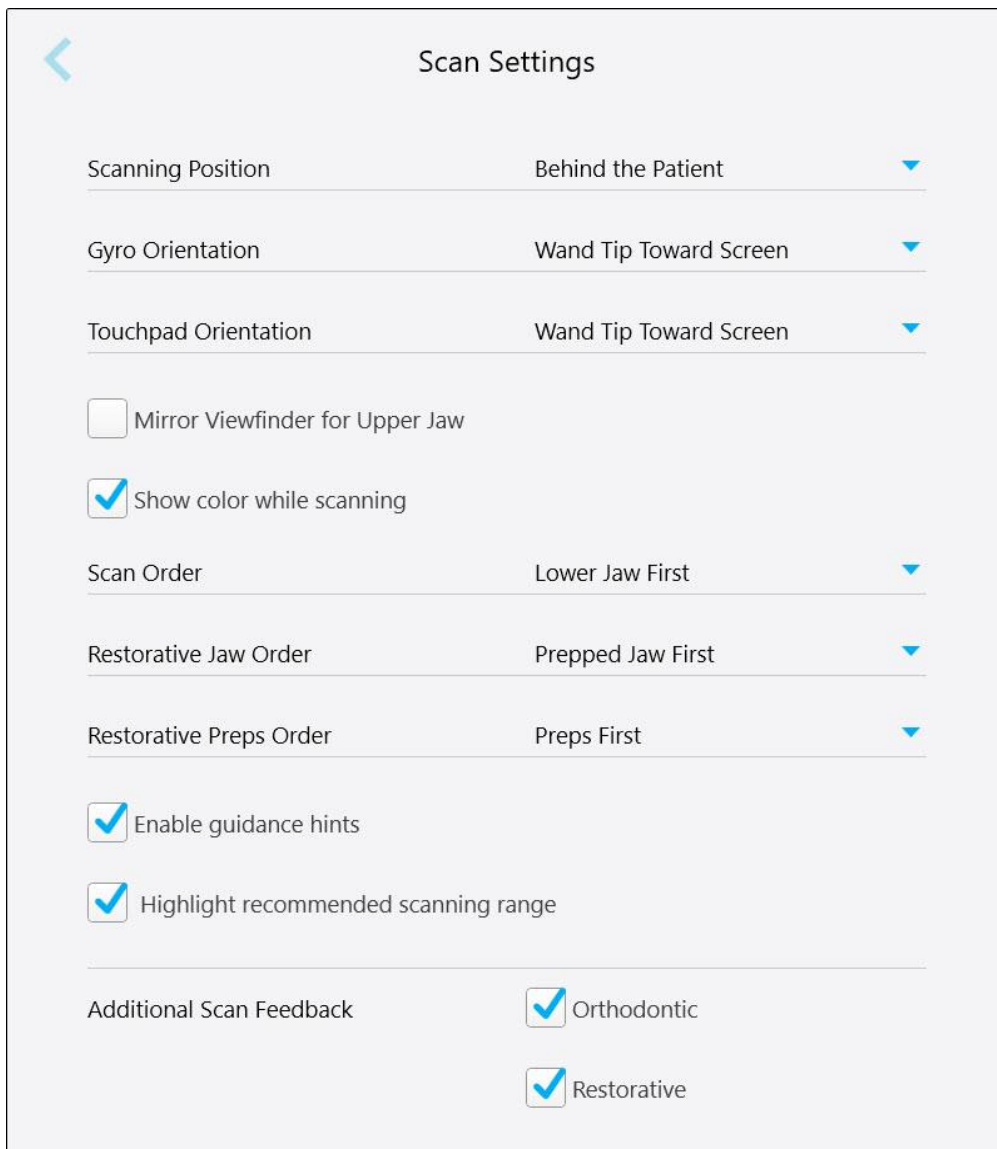

Figure 59: Scan Settings window

2. Select the default scanning preferences from the *Scan Settings* window.

Scan setting	Scan options
Scanning Position	Select your position while scanning the patient: <ul style="list-style-type: none"> • Behind the patient • In front of the patient
Gyro Orientation	Select the default gyro orientation: <ul style="list-style-type: none"> • Wand Tip Toward Screen • Wand Base Toward Screen
Touchpad Orientation	Select the default touchpad orientation: <ul style="list-style-type: none"> • Wand Tip Toward Screen • Wand Base Toward Screen
Mirror Viewfinder for Upper Jaw check box	Select this check box to define the orientation of the viewfinder when scanning the upper jaw.
Show color while scanning check box	Select this check box to show the 3D model in color while scanning, by default.
Scan Order	Select the order in which to scan the jaws: <ul style="list-style-type: none"> • Upper Jaw First • Lower Jaw First
Restorative Jaw Order	Select the order in which to scan the jaws for fixed restorative procedures: <ul style="list-style-type: none"> • Opposite Jaw First • Prepped Jaw First
Restorative Preps Order	Select the order in which to scan the prepped teeth and the arches in fixed restorative procedures: <ul style="list-style-type: none"> • Preps First • Arch First • No Guidance
Enable guidance hints check box	Select this check box to display guidance when scanning, as described in Scanning guidance .

Scan setting

Highlight recommended scanning range check box

Scan options

Select this check box to highlight only the scanning range on the navigation controls.

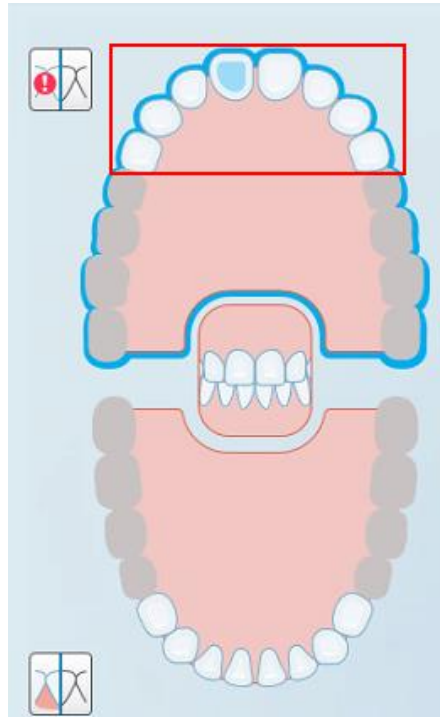



Figure 60: Only the scanning range is highlighted

Additional Scan Feedback

Select the relevant check boxes to display areas of missing anatomy while scanning, as described in [Additional scan feedback](#).

- Orthodontic
- Restorative

3. Tap  to save the changes and return to the *Settings* window.

4.6.2.2 Defining the Rx settings

You can define the settings that are displayed by default when you open the *Scan Details* window to fill in a new Rx.

To define the Rx settings:

1. Tap the **Rx Settings** button.

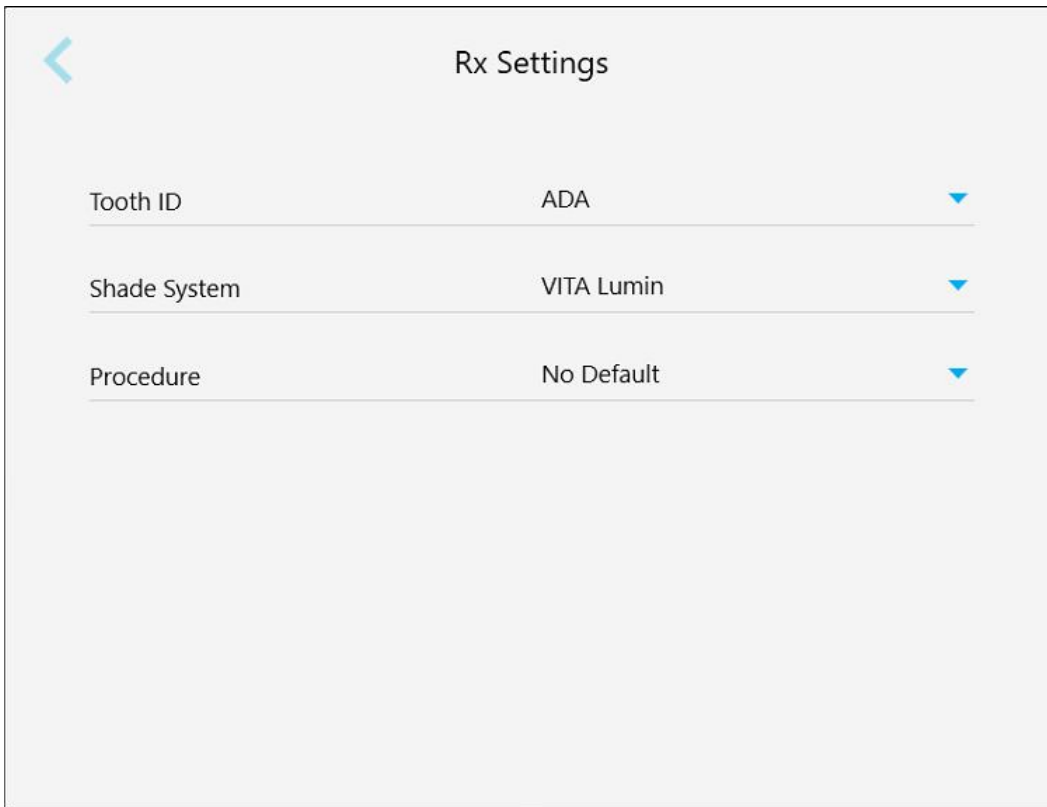



Figure 61: Rx Settings window

2. Select the default Rx preferences from the *Rx Settings* window.

Rx setting	Rx options
Tooth ID	Select the default tooth ID system: <ul style="list-style-type: none"> • FDI • ADA • Quadrant
Shade System	Select the default shade system: <ul style="list-style-type: none"> • VITA Lumin • VITApan 3D Master • Other
Procedure	Select the default procedure: <ul style="list-style-type: none"> • Appliance • Denture/Removable • Fixed Restorative • Implant Planning • Invisalign • Study Model/iRecord • No Default <p>Note: The list of available procedures changes according to your iTero subscription package.</p>

3. Tap  to save the changes and return to the *Settings* window.

4.6.2.3 Defining the signature settings

You can define the default settings that are displayed when sending an order to the lab.

To define the signatures settings:

1. Tap the **Signature Settings** button.

Figure 62: Signature Settings window

2. Define the default signature settings.

Signature setting	Signature options
License	Add your license number.
Signature	Add your signature.
Signature Usage	Select one of the following signature options: <ul style="list-style-type: none"> • Sign once and save for use with each Rx. • Do not save my signature (requires a signature for each Rx). • Disable this function (for this user only).

3. Tap to save the changes and return to the *Settings* window.

4.6.2.4 Defining the language settings

Tap the **Language** button, select the required language from the drop-down list, and then tap  to save the changes and return to the *Settings* window.

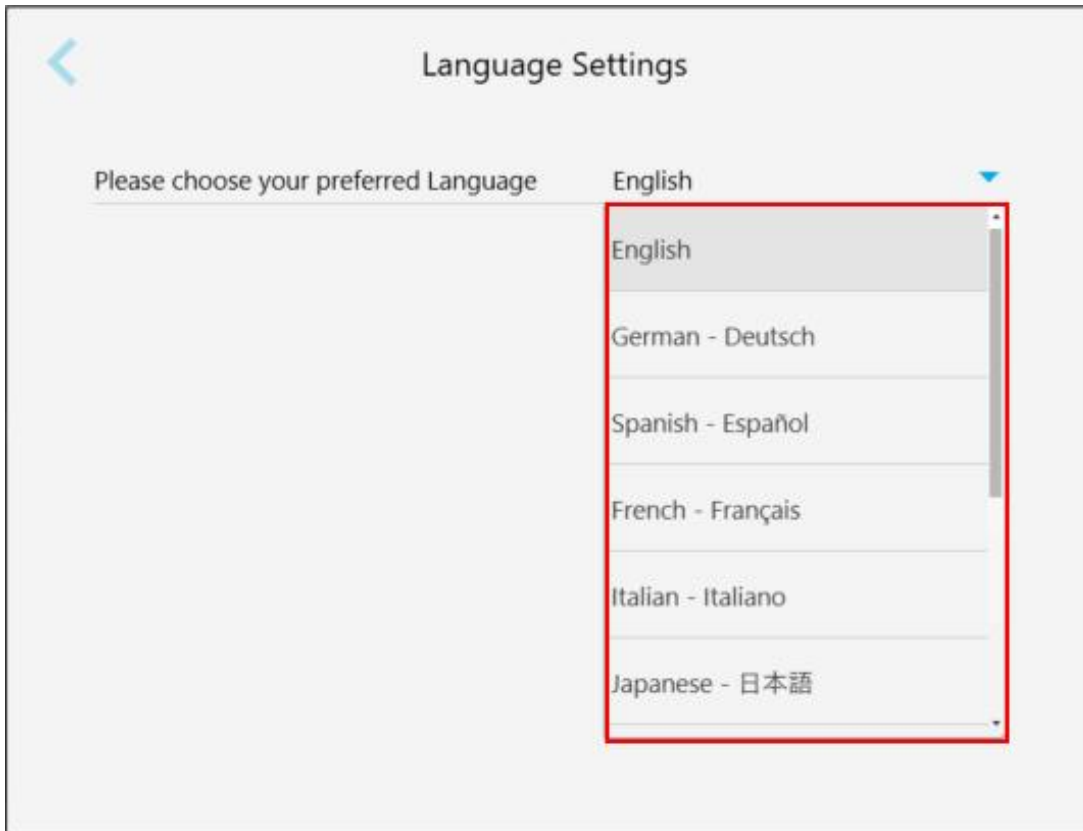

Figure 63: Language Settings window

4.6.3 Defining the System settings

The System settings enable you to set the login settings, run diagnostics, view the licenses, view the system information, synchronize new updates from the server, and define the export settings.

4.6.3.1 Defining the login settings

In order to comply with privacy and security regulations, you will be logged out of the scanner after a predefined period of inactivity. By default, this time is set to 1 hour, but you can change it if required.

Notes:

- To ensure patient privacy, it is recommended to not increase the inactivity period to more than the default 1 hour.
- You will not be logged out of the scanner while the scanner is in Scan mode.

To define the period of inactivity:

1. Tap the **Login Settings** button.

The *Login Settings* window is displayed.

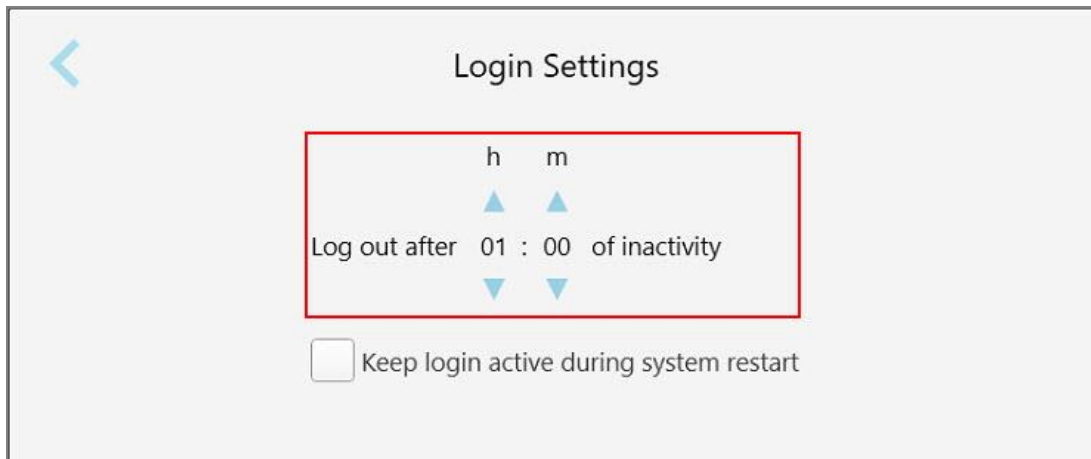



Figure 64: Login Settings window

2. Select the period of inactivity after which the user will be logged out of the scanner. (Min time: 10 minutes, Max time: 8 hours)
3. Select the **Keep login active during system restart** check box to remember the user's password if the system restarts before the inactivity logout period has elapsed.
4. Tap  to save the changes and return to the *Settings* window.

4.6.3.2 Running diagnostics

Tap the **Diagnostics** button to check the network connection and speed.

To run system diagnostics:

1. Tap the **Diagnostics** button.

The network connection and speed are checked.

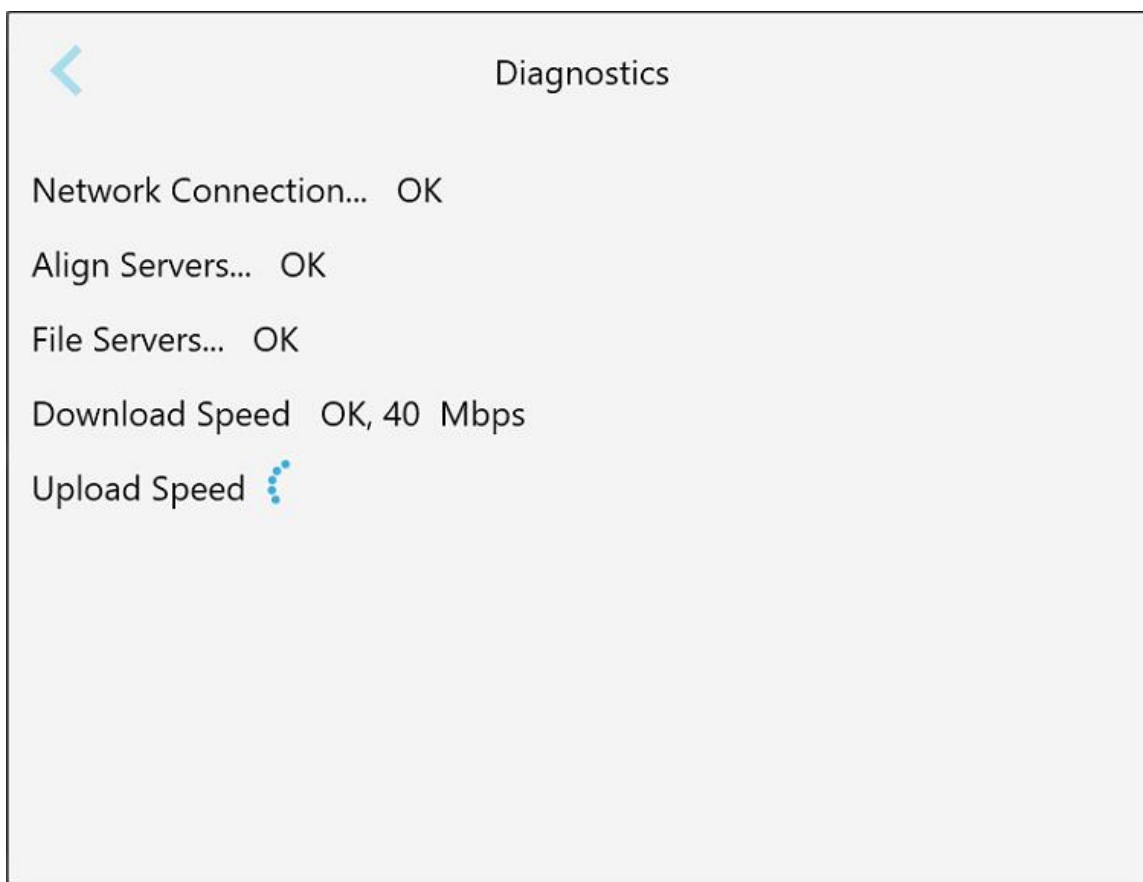



Figure 65: Diagnostics window

2. Tap  to return to the *Settings* window.

4.6.3.3 Licenses

Tap the **Licenses** button to view a list of third-party software components installed on the scanner and then tap  to return to the *Settings* window.

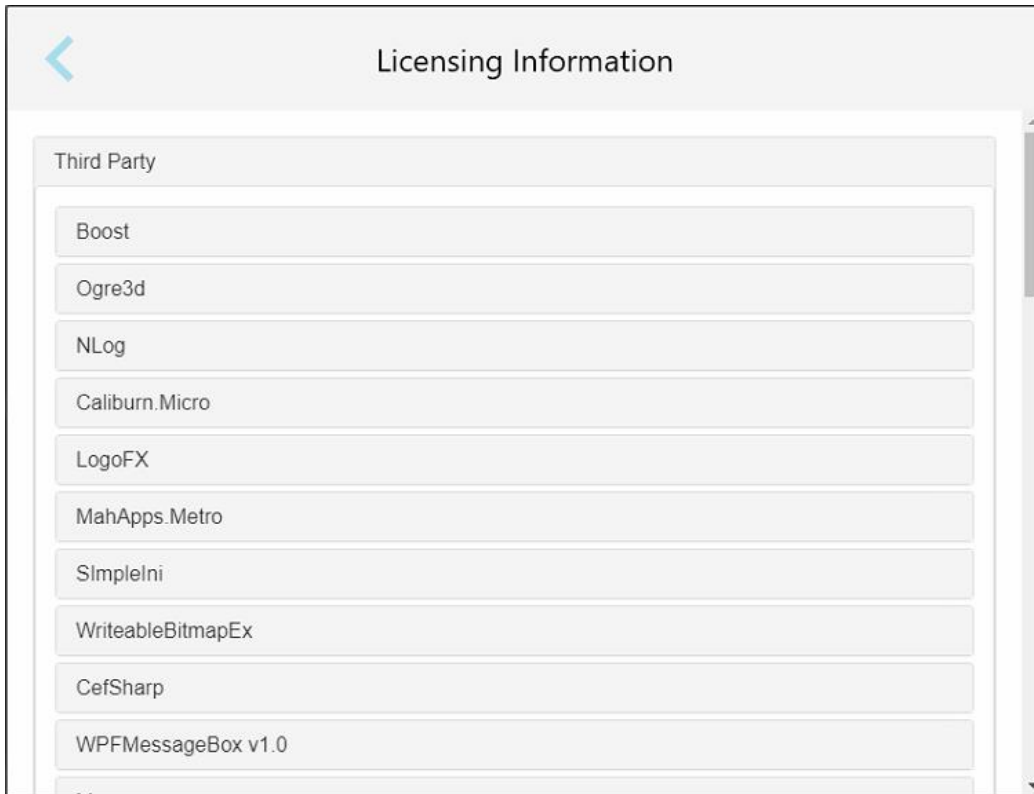



Figure 66: Licensing Information window

4.6.3.4 System information

Tap the **System Information** button to view details about the software versions currently installed and the hardware serial numbers and ID, and then tap  to return to the *Settings* window.

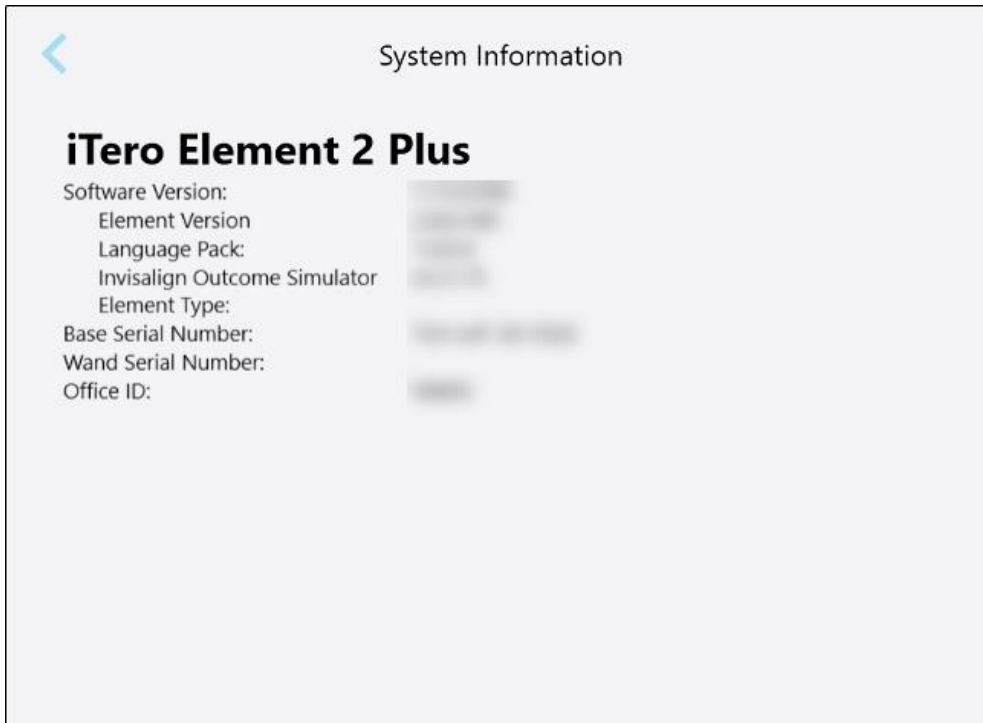

Figure 67: System Information window – iTero Element 2 Plus

4.6.3.5 Sync configuration

Tap the **Sync Configuration** button to synchronize any new updates from the server, for example, new software options.

4.6.3.6 Export settings

You can define how long exported files should be kept before being deleted. In addition, you can view the local network address of the exported files, in boldface letters (starting with “\”). This address is accessible from any computer within the local network.

Note: If required, you can export the files at any time from MyiTero.

To edit the export settings:

1. Tap the **Export Settings** button.
2. Select the number of days after which exported files should be deleted. By default, this is set at 30 days.



Figure 68: Export Settings window – deleting exported files

3. If required, tap **Clear Export Data Now** to delete the exported files immediately.
4. Tap  to return to the *Settings* window.

5 Starting a new scan

Before starting a new scan, you must:

- Check whether there are any particles on the wand. If so, repeat the cleaning and disinfection process, described in [Cleaning and disinfecting the wand](#).
- Apply a new wand sleeve to prevent cross-contamination, as described below.
Note: If you notice any damage, do not use the sleeves and contact Customer Support.
- Fill in the Rx form in the *New Scan* window.
 - Enter the details of a new patient into your iTero system, described in [Adding new patients](#), or search for an existing patient, described in [Searching for existing patients](#).
 - Enter the details of the procedure required, described in [Filling in the Rx](#).

5.1 Applying a wand sleeve

To apply a wand sleeve:

1. Gently remove the blue protective sleeve from the wand.
2. Gently slide a new sleeve onto the tip of the wand until it clicks into place.

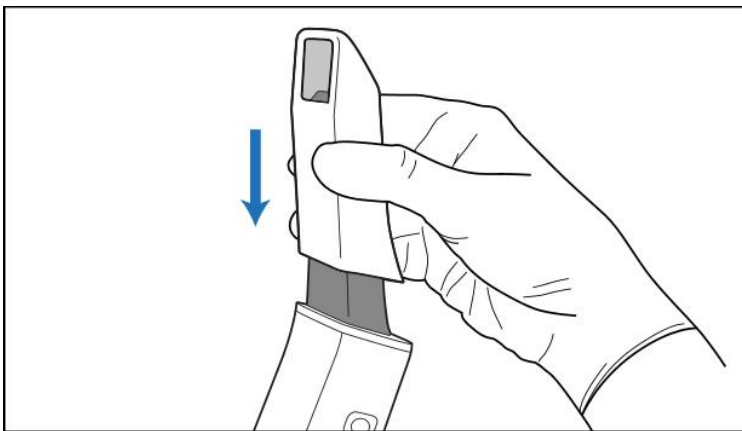
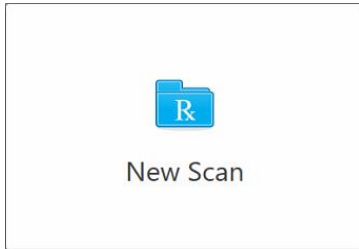

Figure 69: Gently slide the new sleeve into place

5.2 Starting the scanning process

On the home screen, tap the **New Scan** button to start the scanning process.



The *New Scan* window is displayed, as well as a toolbar that shows your progress throughout the scanning process.

A screenshot of the 'New Scan' application window. At the top, there is a title bar with 'New Scan' and a toolbar with icons for 'R', a scanner, a magnifying glass, and an envelope. Below the title bar, the form is divided into sections: 'Doctor' (Dr. Demo, Demo; License: 12345), 'Patient' (with fields for First Name, Last Name, Date of Birth, Gender, and Chart Number), 'Order' (with fields for Procedure, Type, Due Date, and Send to), and 'Notes' (with an 'Add Note' field).

Figure 70: New Scan window showing an empty Rx form and progress toolbar

The *New Scan* window shows the Rx form, which is made up of the following areas:

- **Doctor:** Displays the doctor's name and license number.
- **Patient:** Enables you to add a new patient to your iTerio system or search for an existing patient for whom to prescribe the treatment. Once the patient's details are displayed, you can edit them, or clear the details from the *New Scan* window. For more information, see [Patient management](#).
- **Order:** Enables you to define the details of the required procedure, for example, Invisalign.
- **Scan Options:** Enables you to turn on toggles regarding, for example, whether the order should include a multi-bite scan.

- **Notes:** Enables you to enter any specific notes to the lab regarding the patient's treatment. For example, you can write special instructions for delivery or manufacturing. Tap anywhere outside the **Notes** area to add the note. Each note shows the author of the note, with a timestamp, and can be edited and deleted.

Additional areas and options may be displayed, depending on the procedure and procedure type selected in the **Order** area.

The scanning process requires the following steps, which are displayed on the toolbar:



[Filling in the Rx](#)



[Scanning the patient](#)



[Viewing the scan](#)



[Sending the scan](#)

Your current progress is highlighted on the toolbar.

5.3 Filling in the Rx

The first step in the scanning process is filling in the Rx (prescription) form. The *New Scan* window has a simple, intuitive workflow that fulfills all restorative and orthodontic application needs. It enables efficient collaboration with the labs and reduced back and forth by ensuring that all information required by the lab for production is included.

After entering the patient details, you can enter the details about the required procedure and procedure type, if relevant, as well as enter notes for the lab regarding the scan. Fields marked with a red asterisk are mandatory before scanning.

Note for Fixed Restorative and Denture/Removable procedures: Some fields become mandatory only after scanning, before sending the scan.

The screenshot shows the 'New Scan' window with the following fields and sections:

- Doctor:** Dr. Demo, Demo; License: 12345
- Patient:** Search icon, Clear button, First Name, Last Name, Date of Birth, Gender (Male/Female), Chart Number.
- Order:** Procedure, Type, Due Date, Send to.
- Notes:** Add Note.

Figure 71: New Scan window

To fill in the Rx:

1. In the **Patient** area, enter the first name and last name of the new patient.
If required, enter the patient's date of birth, gender, and a unique chart number.

Or

Tap  to search for an existing patient, as described in [Searching for existing patients](#).

- In the **Order** area, from the **Procedure** drop-down list, select the required procedure.

Note: The list of procedures displayed depends on your iTero subscription package.

The screenshot shows a form titled 'Order:'. On the left, there is a dropdown menu labeled 'Procedure *' with a blue downward arrow. A red rectangular box highlights this dropdown menu, which is currently open, showing a list of procedure options: 'Study Model/iRecord', 'Invisalign', 'Fixed Restorative', 'Implant Planning', 'Denture/Removable', and 'Appliance'. To the right of the dropdown menu, there are two more dropdown menus: 'Type' and 'Send to', both with blue downward arrows. Below these dropdowns, there is a large empty rectangular input field.

Figure 72: Selecting the required procedure

The following procedures are available by default, depending on whether you have a Restorative or Orthodontic subscription package:

- **Study Model/iRecord:** A simple scan with no additional modification, mainly used for studying purposes and referencing instead of storing the plaster model, as required by law. It can also be scanned as iCast, and is available on your Invisalign Doctor Site. For more information, see [Filling in the Rx for Study Model/iRecord procedures](#).
- **Invisalign:** The basic scan for all Invisalign treatments, including retainers. For more information, see [Filling in the Rx for Invisalign procedures](#).
- **Fixed Restorative:** A scan for all restorative treatments, for example, crowns and bridges. For more information, see [Filling in the Rx for Fixed Restorative procedures](#).
- **Implant Planning:** Enables ordering a surgical guide from the lab. For more information, see [Filling in the Rx for Implant Planning procedures](#).
- **Denture/Removable:** Enables comprehensive planning and fabrication of partial and full dentures. For more information, see [Filling in the Rx for Denture/Removable procedures](#).
- **Appliance:** Enables you to create a prescription for various dental appliances, for example, night guards and Apnea/Sleep appliances. For more information, see [Filling in the Rx for Appliance procedures](#).

The **Order** and **Scan Options** areas of the *New Scan* window are displayed according to the selected procedure.

- If relevant, from the **Type** drop-down list, select the procedure type required.

Note: Procedure types are not relevant for Study Model/iRecord and Fixed Restorative procedures.
- If required, tap the calendar in the **Due Date** field and then select the date the case is due back from the lab.
- If required, from the **Send To** drop-down list, select the lab to which the scan should be sent, or your own chairside software. If you do not select anything, the scan will be sent to MyiTero only.
- Depending on the procedure selected, fill in the relevant additional details.

7. In the **Scan Options** area, turn on/off the following toggles, depending on the procedure selected, as required.
 - **Multi-Bite:** Turn on the **Multi-Bite** toggle if a multi-bite scan is required. This enables you to preserve the 2-bite relation based on your needs, and delivers comprehensive bite information to the lab for appliance fabrication.

For Invisalign from Study Model/iRecord procedures, it is recommended that the first bite is scanned bilaterally. Only the first bite will be used in the ClinCheck software.
 - **Pre-Treatment Scan:** Turn on the **Pre-Treatment Scan** toggle if you would like to scan the patient before prepping the relevant tooth. In this case, the patient must be scanned twice – before and after the tooth has been prepped. The pre-treatment scan enables the lab to copy the original anatomy to the new restoration.
8. Depending on the procedure and procedure type selected, enter the relevant details in the additional areas that are displayed, for example, the **Tooth Diagram** area or the **Denture Details** area.
9. In the **Notes** area, if required, enter any specific notes to the lab regarding the patient's treatment. For example, special instructions for delivery or manufacturing. Tap anywhere outside the **Notes** area to add the note. Each note shows the author of the note, with a timestamp, and can be edited and deleted.
10. Tap  on the toolbar to move to Scan mode to scan the patient, as described in [Scanning the patient](#).

5.3.1 Filling in the Rx for Study Model/iRecord procedures

The **Study Model/iRecord** procedure requires a simple scan without any additional modification.

If you are an Invisalign doctor, all scans will be uploaded to the Invisalign Doctor Site and will be available in the ClinCheck software.

To fill in the Rx for a Study Model/iRecord procedure:

1. In the **Patient** area, enter a patient's details or search for an existing patient, as described in [Searching for existing patients](#).
2. In the **Order** area, select **Study Model/iRecord** from the **Procedure** drop-down list.

The *New Scan* window expands to display a **Scan Options** area and is displayed as follows:

The screenshot shows the 'New Scan' window with the following sections:

- Header:** Doctor: Dr. Demo, Demo; License: 12345
- Patient:** Search bar with 'Clear' button. Fields for First Name (Patient), Last Name (Demo), Date of Birth, Gender (Male/Female), and Chart Number.
- Order:** A red box highlights this section. It contains a message: 'All Study Model/iRecord scans are available for Invisalign.' Below it, a 'Procedure' dropdown is set to 'Study Model/iRecord', an 'Ortho Model/iCast' toggle is turned on, a 'Due Date' field, and a 'Send to' dropdown.
- Scan Options:** A red box highlights this section. It contains a 'Multi-Bite' toggle.
- Notes:** A text area with the placeholder 'Add Note'.

Figure 73: Order and Scan Options areas – Study Model/iRecord procedure

3. If required, turn on the **Ortho Model/iCast** toggle to order a digital dental case.
4. Continue filling in the prescription from step 5, as described in [Filling in the Rx](#).

5.3.2 Filling in the Rx for Invisalign procedures

The Invisalign procedure is used to create prescriptions for all Invisalign orders, including retainers. The model must be scanned without any holes to ensure that the aligners are a perfect fit with the patient's teeth.

To fill in the Rx for an Invisalign procedure:

1. In the **Patient** area, enter a patient's details or search for an existing patient, as described in [Searching for existing patients](#).
2. In the **Order** area, select **Invisalign** from the **Procedure** drop-down list.

The *New Scan* window is displayed as follows:

The screenshot shows the 'New Scan' window with the following fields:

- Doctor:** Dr. Demo, Demo
- License:** 12345
- Patient:**
 - First Name: * Patient
 - Last Name: * Demo
 - Date of Birth:
 - Gender: Male Female
 - Chart Number:
- Order:** (highlighted with a red box)
 - Procedure: * Invisalign
 - Type: * Invisalign Aligners
 - Treatment Stage
 - Current Aligner #:
- Notes:**
 - Add Note

Figure 74: Order area – Invisalign procedure

3. From the **Type** drop-down list, select the type of Invisalign procedure required, depending on your iTero subscription package:
 - Invisalign Aligners – Invisalign Outcome Simulator Pro is available only for **Invisalign Aligners** procedure types. For more information on Invisalign Outcome Simulator Pro, see [Invisalign Outcome Simulator Pro](#).
 - Invisalign First Aligners
 - Invisalign First Palatal Expander

Note: Excess soft tissue will not be removed automatically from around the edges of the model during scanning. If required, you can enable automatic cleanup by pressing on the screen and then tapping the Auto Cleanup tool. For more information, see [Disabling auto-cleanup](#).
 - Vivera Retainer – maintains the position of the teeth after treatment. If brackets are still present, they will be removed by the iTero software. The Vivera retainers will be provided at the debonding appointment.
 - Invisalign Retainer
4. For Invisalign Aligners, First Aligners, and First Palatal Expanders, you can select the **Treatment Stage**:
 - Initial Record – for the first Invisalign treatment scan. By default, the Current Aligner # is set to 0.
 - Progress Record – for multiple scans during the ongoing treatment. In addition, enter the patient's current Aligner number in the **Current Aligner #** field.
 - Final Record – for the scan done when treatment is completed. In addition, enter the patient's current Aligner number in the **Current Aligner #** field.
5. Continue filling in the prescription from step 8, as described in [Filling in the Rx](#).

For more information, refer to the Invisalign documentation.

5.3.3 Filling in the Rx for Fixed Restorative procedures

The Fixed Restorative procedure covers a range of restorations, including crowns, bridges, veneers, inlays, onlays, and implant-based restoration. When selecting fixed restorative procedures, you need to select the tooth that needs to be restored, the type of restoration required, as well as the material, shade, etc. of the restoration.

Note: Some fields are not mandatory before scanning the patient but must be filled in before you can send the scan.

To fill in the Rx for a Fixed Restorative procedure:

1. In the **Patient** area, enter a patient's details or search for an existing patient, as described in [Searching for existing patients](#).
2. In the **Order** area, select **Fixed Restorative** from the **Procedure** drop-down list.

The *New Scan* window expands and a **Scan Options** area and a **Tooth Diagram** area showing the tooth numbers and illustrations are displayed in the window.

The screenshot shows the 'New Scan' interface with the following fields and sections:

- Doctor:** Dr. Demo, Demo; **License:** 12345
- Patient:**
 - First Name: Patient1; Last Name: Demo
 - Date of Birth: ; Gender: Male Female
 - Chart Number:
- Order:**
 - Procedure: Fixed Restorative; Type:
 - Due Date: ; Send to:
- Scan Options:**
 - Pre-Treatment Scan:
- Tooth Diagram:** A grid of 32 tooth icons numbered 1 through 32, arranged in two rows of 16.
- Notes:** Add Note

Figure 75: Scan Options and Tooth Diagram areas – Fixed Restorative procedure

3. If required, tap the calendar in the **Due Date** field and then select the date the restoration is due from the lab.
4. If required, from the **Send To** drop-down list, select the lab to which the scan should be sent, or your own chairside software.
5. In the **Scan Options** area, turn on/off the following toggles, as required.
 - **Pre-Treatment Scan:** Turn on the **Pre-Treatment Scan** toggle if you would like to scan the patient before prepping the relevant tooth. In this case, the patient must be scanned twice – before and after the tooth has been prepped. The pre-treatment scan enables the lab to copy the original anatomy to the new restoration.
6. In the **Tooth Diagram** area, tap the tooth to be restored.

A list of available options for the selected tooth is displayed.

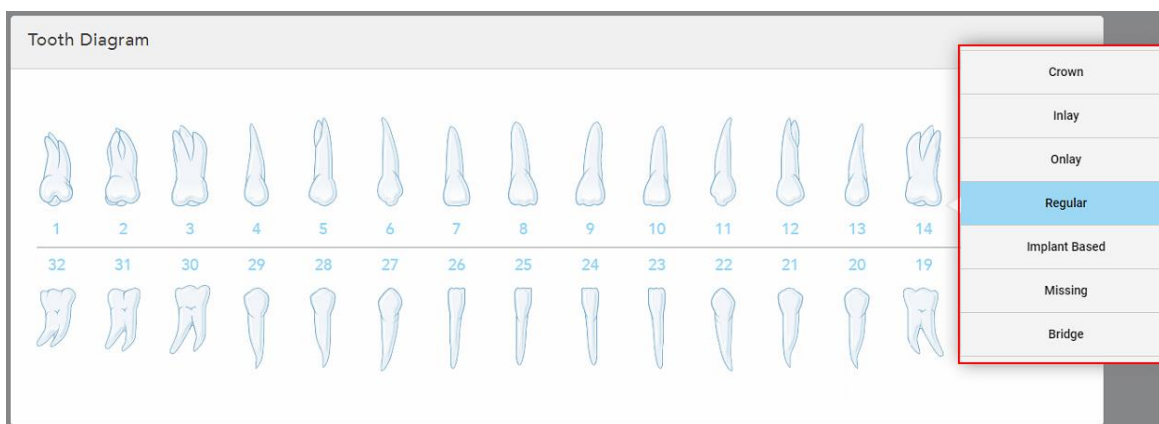

Figure 76: List of fixed restorative treatment options

7. Select the required treatment option.

Depending on the fixed restorative treatment option selected, a treatment window is displayed.

Note: Treatment options are mandatory before sending the scan, but can be filled in after scanning.

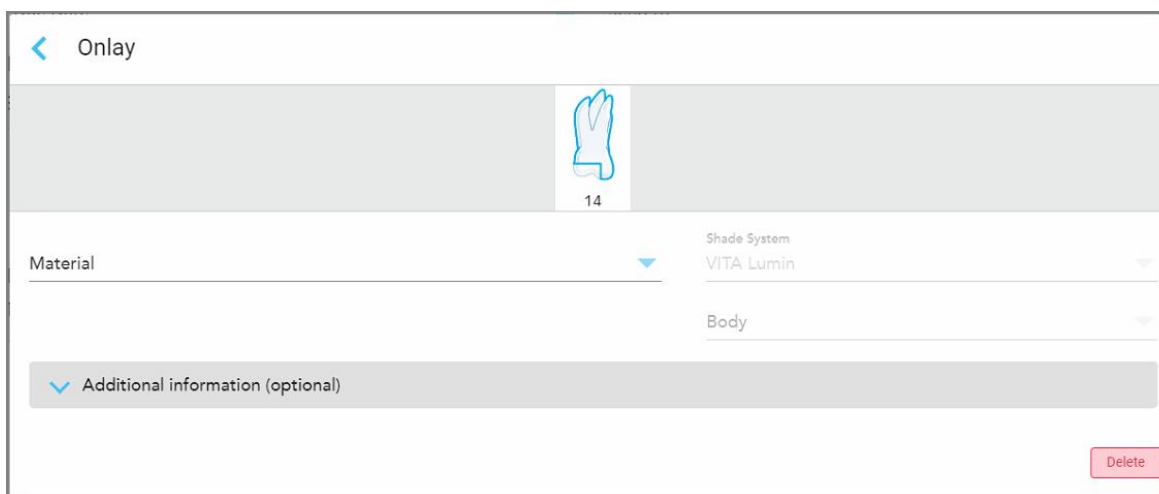

Figure 77: Treatment settings window – Onlay restoration

8. Select the relevant treatment settings for each tooth, according to the treatment option selected:
 - **Crown**, described in [Crown, Veneer, Laminates, Inlay, and Onlay restorations](#)
 - **Inlay/Onlay** (relevant for molars and premolars only), described in [Crown, Veneer, Laminates, Inlay, and Onlay restorations](#)
 - **Implant Based**, described in [Implant Based restorations](#)

Note: If an implant abutment is already in the mouth, select Crown from the drop-down list.

 - **Veneers/Laminates** (relevant for the incisors and premolars only), described in [Crown, Veneer, Laminates,](#)

[Inlay, and Onlay restorations](#)

- **Bridge**, described in [Bridge restorations](#)

In addition:

- If a tooth is missing, tap **Missing**
- To delete a restoration plan, tap **Regular**

9. Tap  to save the selection and return to the *New Scan* window.

The selected teeth are highlighted and the selected treatment options are displayed in the **Treatment Information** area below the **Tooth Diagram** area.

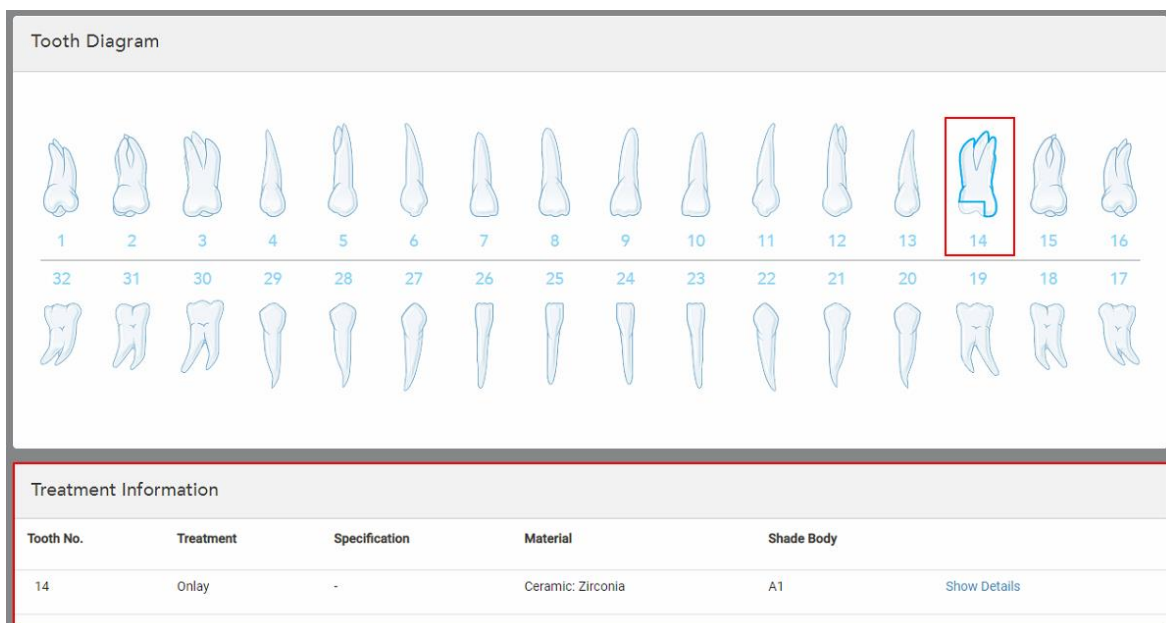

Figure 78: Selected tooth and Treatment Information area – Onlay restoration

You can change the selected treatment options at any time before sending the scan by tapping **Show Details** and editing the settings of a specific tooth.

10. In the **Notes** area, if required, enter any specific notes to the lab regarding the patient’s treatment. For example, special instructions for delivery or manufacturing. Tap anywhere outside the **Notes** area to add the note. Each note shows the author of the note, with a timestamp, and can be edited and deleted.

5.3.3.1 Crown, Veneer, Laminates, Inlay, and Onlay restorations

Follow the procedure below to complete filling in the Rx for Crown, Veneer, Laminates, Inlay, and Onlay restorations.

Note: If more than one tooth requires restoration, you can copy the treatment settings to each tooth requiring the same restoration type.

To fill in the Rx for a Crown, Veneer, Laminates, Inlay, or Onlay restoration:

1. In the **Tooth Diagram**, tap the tooth that needs restoration and then select the required treatment option from the drop-down list, for example, **Crown**.

The **Crown** treatment settings window is displayed.

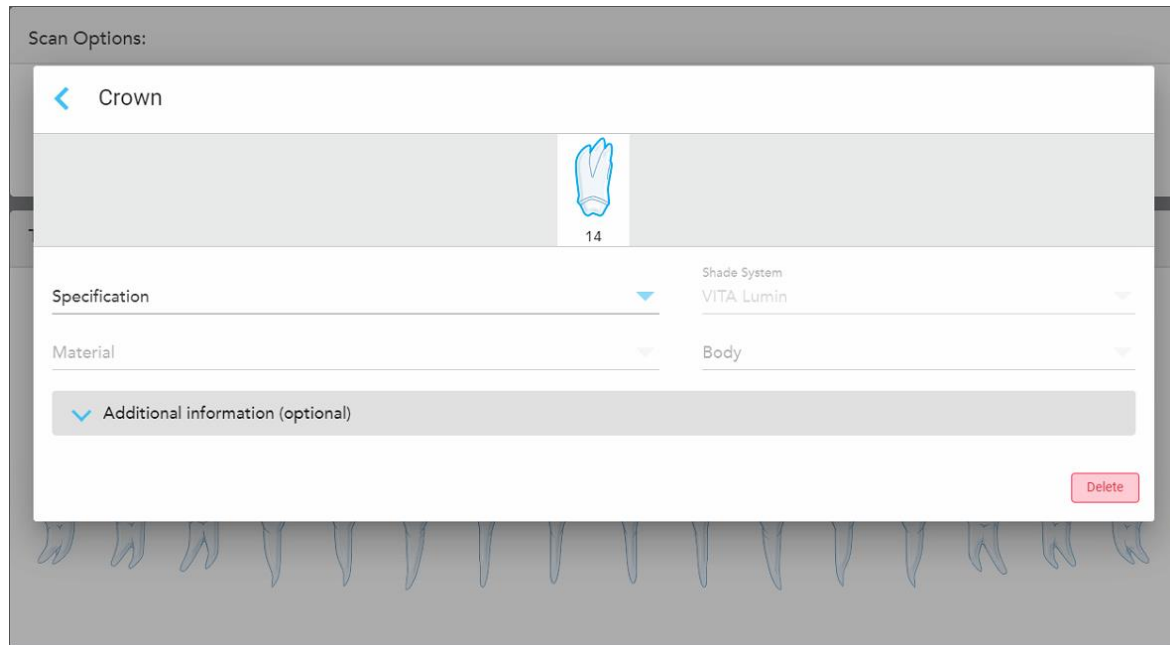

Figure 79: Treatment settings window – Crown restoration

2. Select the following mandatory settings from the relevant drop-down lists:
 - a. **Specification:** The type of crown to be fabricated.

Note: Relevant for Crown treatments only. Once you have selected the type of crown required, you can select the rest of the options.
 - b. **Material:** The material from which the restoration should be fabricated, depending on the specification selected. This can be copied to all teeth included in the restoration.
 - c. **Shade System:** The system used for choosing the shade of the restoration.
 - d. **Body:** The shade for the body area of the restoration.

3. If required, tap  to expand the **Additional information** area to display additional optional settings:

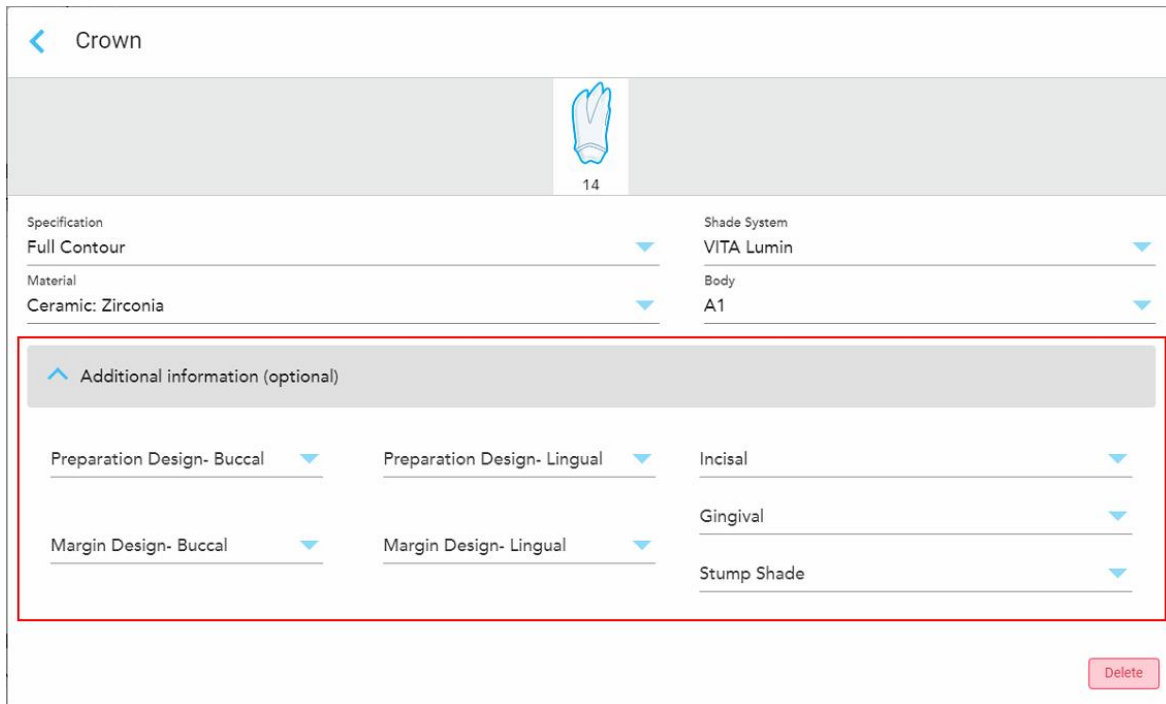



Figure 80: Additional information area – Crown restoration

- **Preparation Design (Buccal and Lingual):** The shape of the finishing line (margin line) created by the user during the preparation. You can choose this for both the buccal and the lingual.
 - **Margin Design (Buccal and Lingual):** The type of ceramic-metal border relationship required for the selected metal-based crown. You must choose this for both the buccal and the lingual. This is relevant only for metal dental work.
 - **Incisal:** The shade for the incisal area of the restoration.
 - **Gingival:** The shade for the gingival area of the restoration.
 - **Stump Shade:** The shade of the prepped tooth.
4. Tap  to save the selection and return to the *New Scan* window.

The selected treatment options are displayed in the **Treatment Information** area below the **Tooth Diagram** area. You can change the selected treatment options at any time before sending the scan by tapping **Show Details** and editing the settings of a specific tooth.

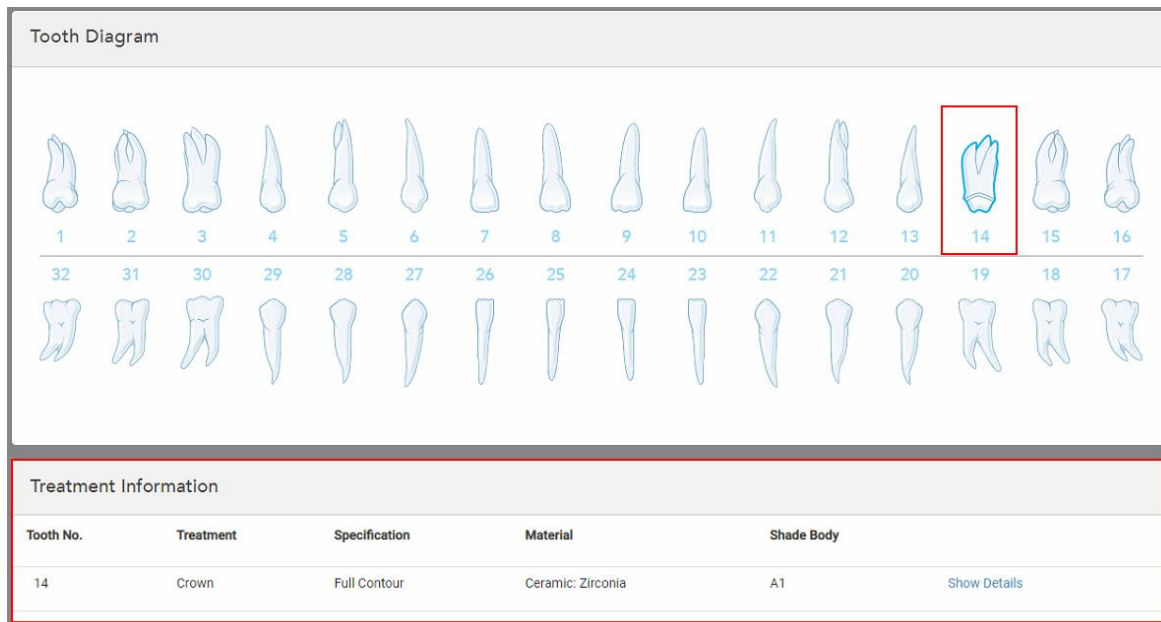

Figure 81: Selected tooth and Treatment Information area – Crown restoration

- Repeat this procedure for each tooth requiring treatment.

If a tooth requires the same treatment as a tooth for which you have already defined the treatment settings, you can copy the settings by tapping the tooth and then selecting **Copy From Tooth #** from the drop-down list.

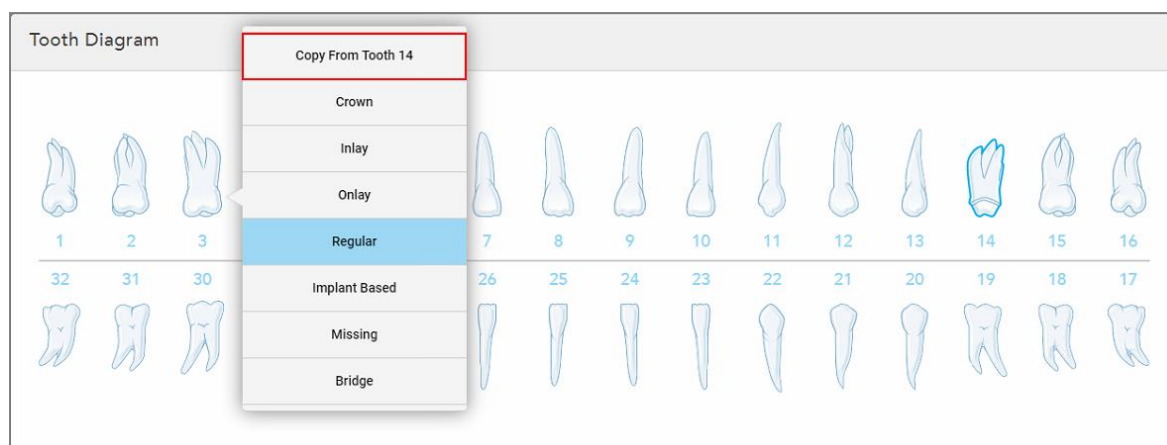

Figure 82: Copy restoration settings from a tooth requiring the same treatment type

The treatment settings are copied to the tooth and are displayed in the **Treatment Information** area below the **Tooth Diagram** area.

- Complete filling in the details in the *New Scan* window, as described in [Filling in the Rx for Fixed Restorative procedures](#).

5.3.3.2 Implant Based restorations

Implant Based restorations are created as part of Fixed Restorative procedures, described in [Filling in the Rx for Fixed Restorative procedures](#).

After starting to fill in the Rx for Fixed Restorative procedures, continue with the procedure below for Implant Based restorations.

Note: If an implant abutment already exists, you should select the **Crown** restoration, as described in [Crown, Veneer, Laminates, Inlay, and Onlay restorations](#).

To fill in the Rx for an Implant Based restoration:

1. In the **Tooth Diagram**, tap the tooth that needs an implant abutment and then select **Implant Based** from the drop-down list.

The **Implant Based** treatment settings window is displayed.

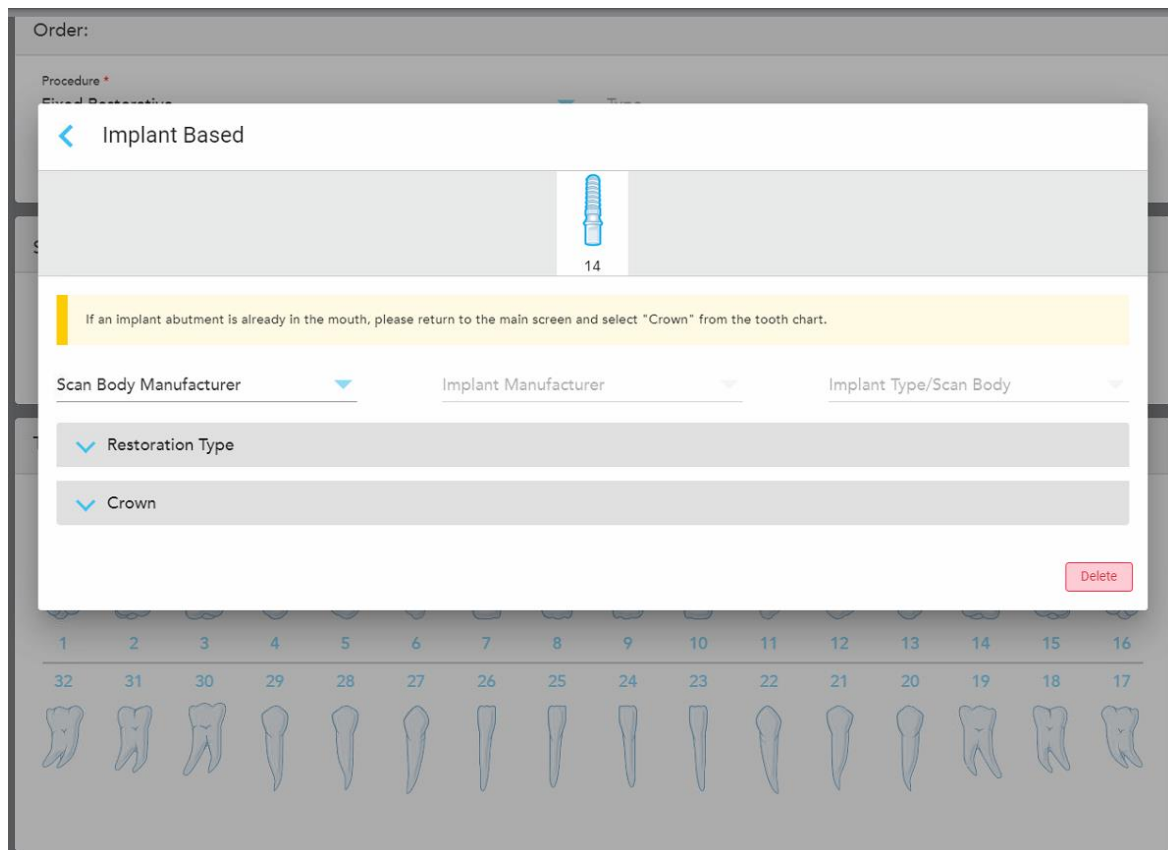

Figure 83: Treatment settings window – Implant Based restoration

2. Select the scan body manufacturer, implant manufacturer, and then the implant type/scan body from the relevant drop-down lists.



- Tap  to expand the **Restoration Type** area and then select the restoration type, abutment type, and abutment material from the relevant drop-down lists. If a titanium base is in place, turn on the **Ti-Base** toggle. You can select these options after scanning, but they must be selected before sending the scan.



Figure 84: Expanded Restoration Type area

- Tap  to expand the **Crown** area and then select the required settings from the relevant drop-down lists, as described in [Crown, Veneer, Laminates, Inlay, and Onlay restorations](#). You can select these options after scanning, but they must be selected before sending the scan.

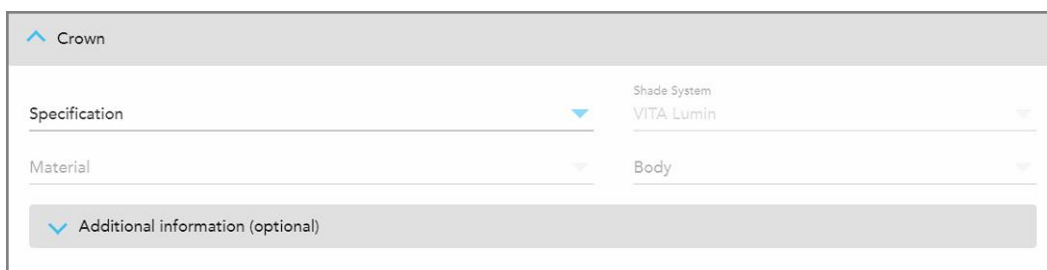



Figure 85: Expanded Crown area

- Tap  to save the selection and return to the *New Scan* window.
- Complete filling in the details in the *New Scan* window, as described in [Filling in the Rx for Fixed Restorative procedures](#).

5.3.3.3 Bridge restorations

Follow the procedure below to complete filling in the Rx for Bridge restorations.

To fill in the Rx for a Bridge restoration:

- In the **Tooth Diagram** area, tap one of the teeth to be included in the bridge and then select **Bridge** from the drop-down list.

The **Bridge** treatment settings window is displayed.

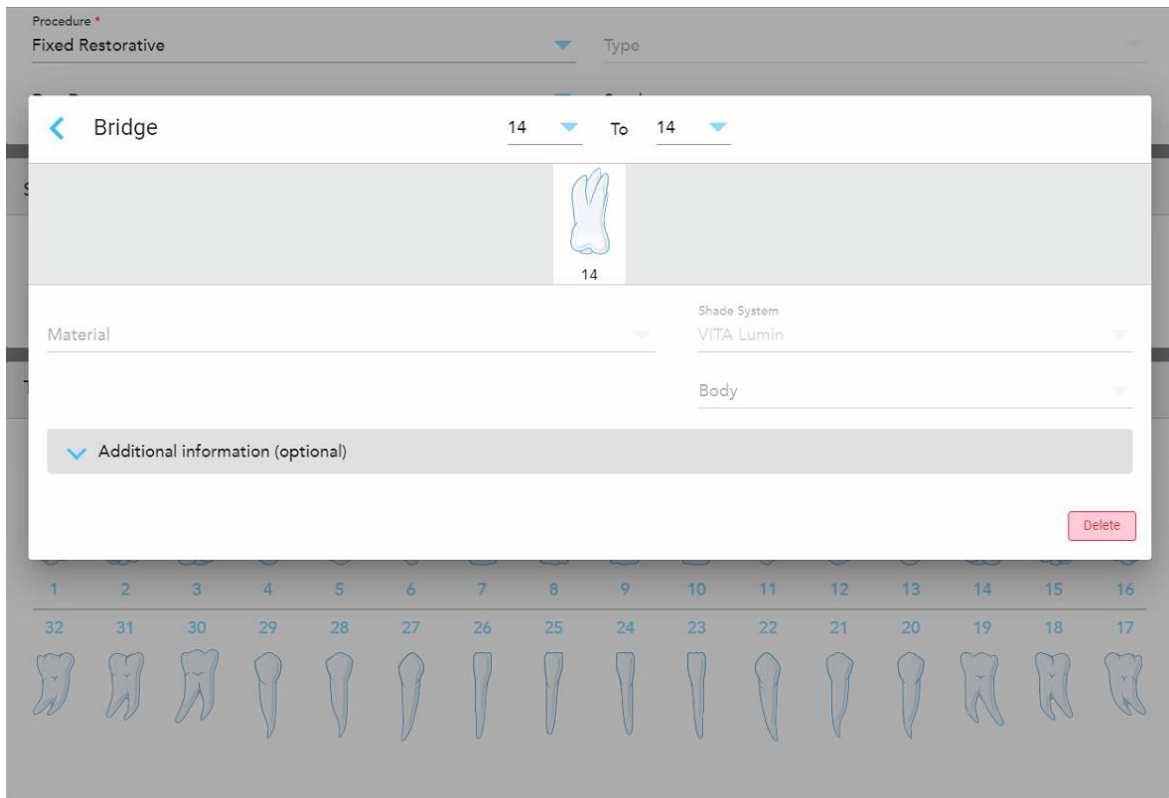

Figure 86: Treatment settings window – Bridge restoration

2. Select the span of the teeth to be included in the bridge from the arrows at the top of the window.

The teeth to be included in the bridge are displayed.

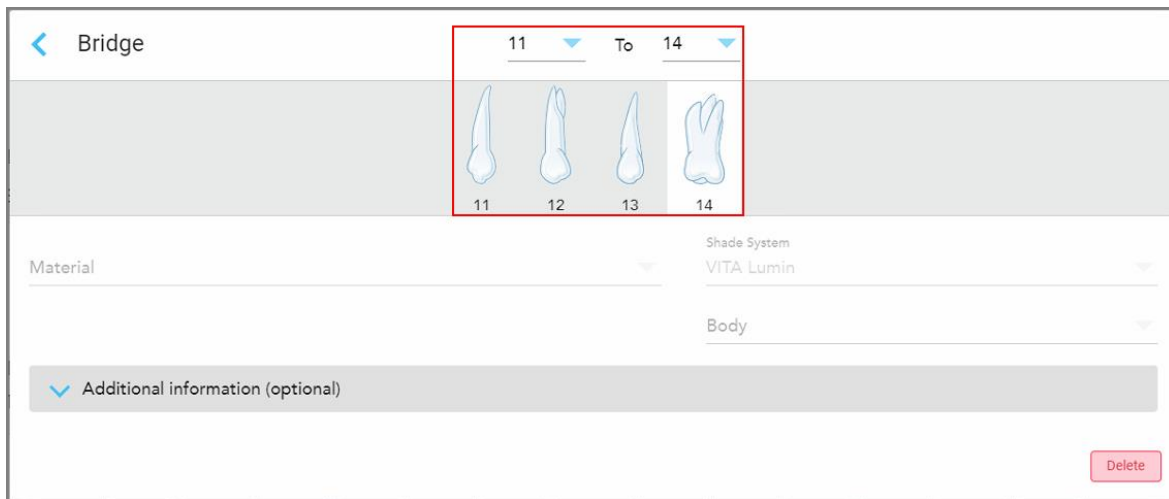

Figure 87: Bridge range and teeth to be included

3. Tap each tooth in the tooth range and then select the in-bridge treatment option from the list:

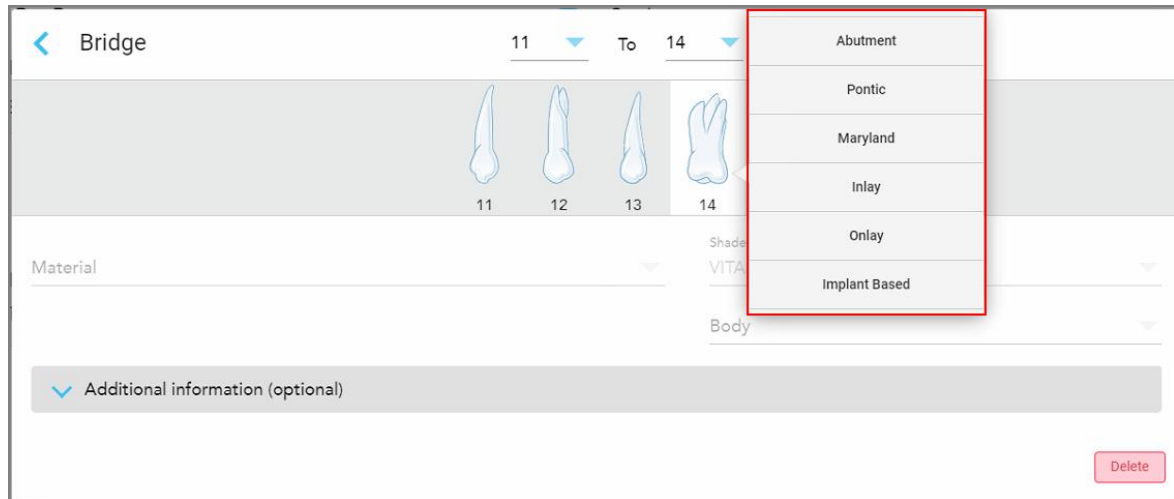

Figure 88: List of in-bridge treatment options

4. For all options besides **Implant Based**:

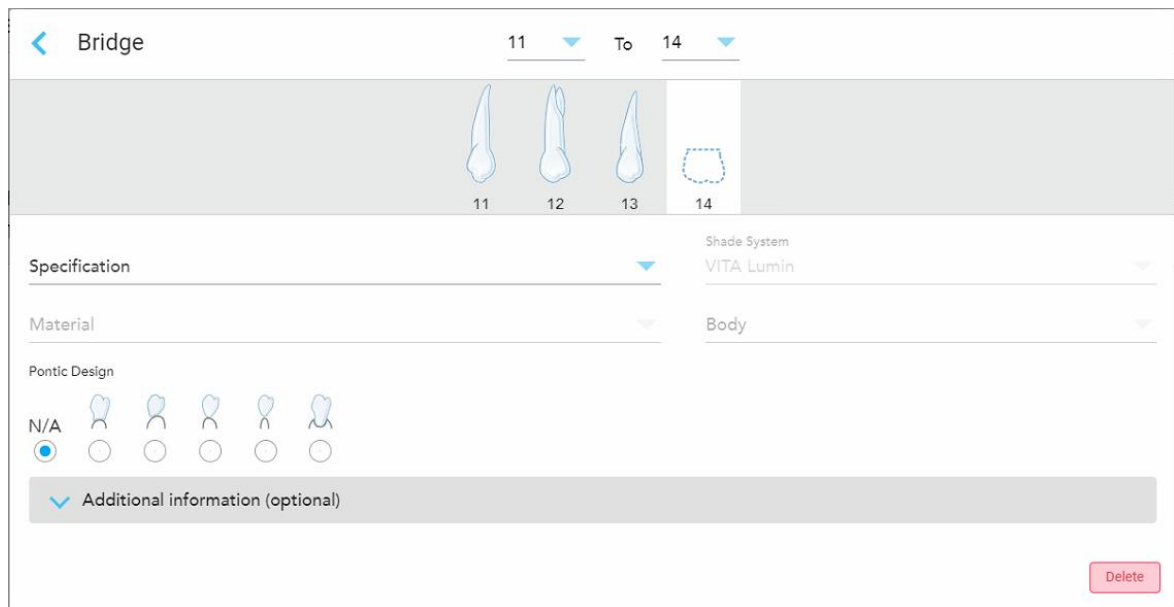

Figure 89: Bridge restoration – Pontic settings

- a. **Specification:** The type of restoration to be fabricated.
- b. **Material:** The material from which the restoration should be fabricated. This is automatically copied to each tooth in the restoration.
- c. **Shade System:** The system used for choosing the shade of the restoration.
- d. **Body:** The shade for the body area of the restoration.
- e. **Pontic Design:** Relevant only if **Pontic** was selected as the in-bridge treatment option.

5. If required, tap  to expand the **Additional information** area to display other optional settings:

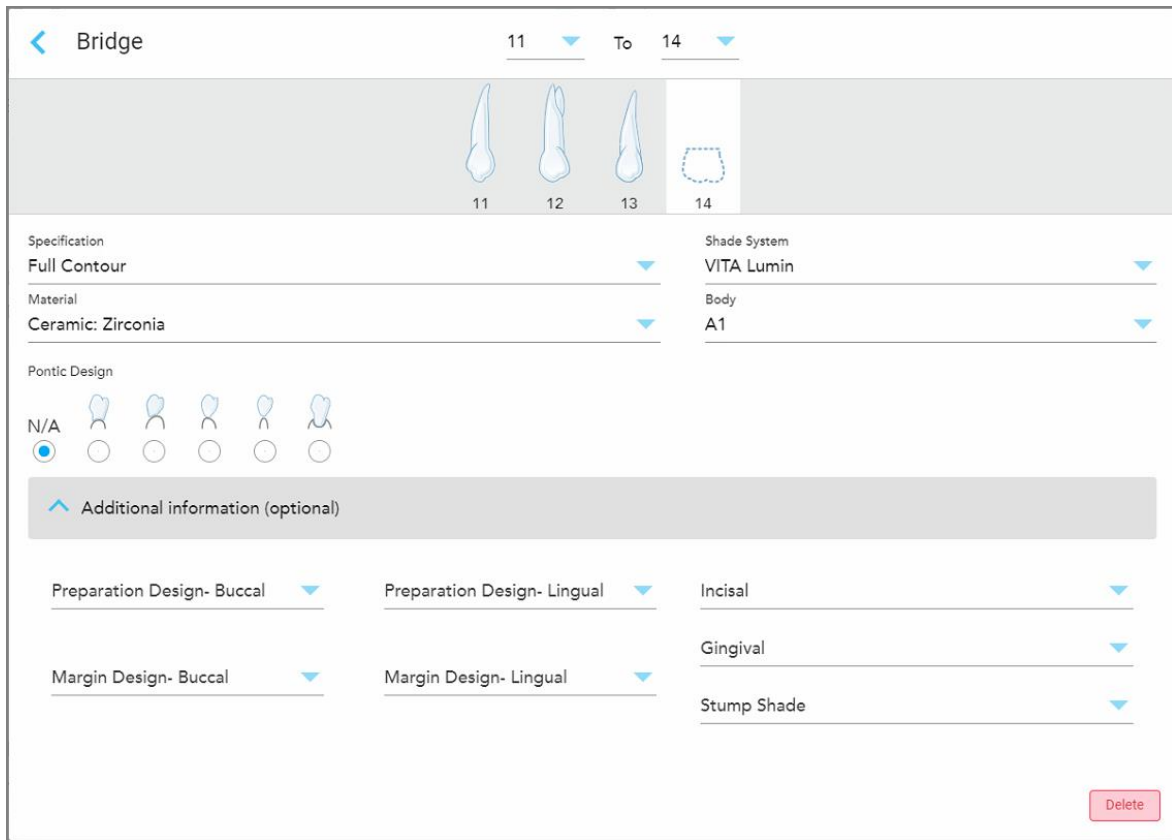

Figure 90: Additional information area – Bridge restoration

- **Preparation Design (Buccal and Lingual):** The shape of the finishing line (margin line) created by the user during the preparation. You can choose this for both the buccal and the lingual.
- **Margin Design (Buccal and Lingual):** The type of ceramic-metal border relationship required for the selected metal-based crown. You must choose this for both the buccal and the lingual. This is relevant only for metal dental work.
- **Incisal:** The shade for the incisal area of the restoration.
- **Gingival:** The shade for the gingival area of the restoration.
- **Stump Shade:** The shade of the prepped tooth.

6. If you selected **Implant Based**, the Bridge treatment options are displayed as follows:

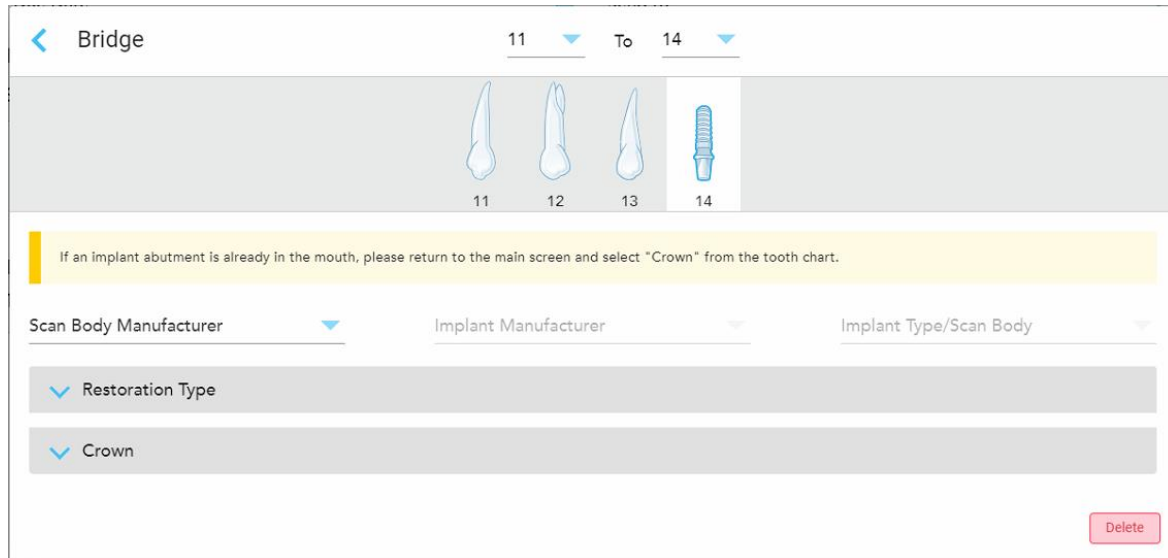



Figure 91: Bridge treatment options – Implant Based

- Select the scan body manufacturer, implant manufacturer, and implant type/scan body from the drop-down lists.
- Tap  to expand the **Restoration Type** area and then select the restoration type, abutment type, and abutment material from the relevant drop-down lists. If a titanium base is in place, turn on the **Ti-Base** toggle.

You can select these options after scanning, but they must be selected before sending the scan.



Figure 92: Expanded Restoration Type area

- Tap  to expand the **Crown** area and then select the required settings from the relevant drop-down lists, as described in [Crown, Veneer, Laminates, Inlay, and Onlay restorations](#).

You can select these options after scanning, but they must be selected before sending the scan.

Figure 93: Expanded Crown area

7. Tap  to save the selection and return to the *New Scan* window.
8. Complete filling in the details in the *New Scan* window, as described in [Filling in the Rx for Fixed Restorative procedures](#).

5.3.4 Filling in the Rx for Implant Planning procedures

The **Implant Planning** procedure enables efficient communication with the labs regarding surgical-guide prescription requirements. If required, orders can also be sent to your chairside software and seamlessly imported directly into exoplan™ or other chairside planning software.

To fill in the Rx for an Implant Planning procedure:

1. In the **Patient** area, enter a patient's details or search for an existing patient, as described in [Searching for existing patients](#).
2. In the **Order** area, select **Implant Planning** from the **Procedure** drop-down list.
3. From the **Type** drop-down list, select the type of surgical guide required:

Figure 94: Implant Planning procedure types

The *New Scan* window expands to show the **Tooth Diagram** area:

The screenshot shows the 'New Scan' window with the following sections:

- Doctor:** Dr. Demo, Demo; License: 12345
- Patient:** Patient1; Last Name: Demo; Gender: Male (selected), Female
- Order:** Procedure: Implant Planning; Type: Surgical Guide Tooth Supported; Due Date: [calendar icon]; Send to: [dropdown]
- Tooth Diagram:** A grid of 32 numbered tooth icons (1-16 in the top row, 32-17 in the bottom row) representing the dental arch.
- Notes:** A text area with the placeholder 'Add Note'.

Figure 95: Implant Planning procedure – Tooth Diagram for Surgical Guide Tooth Supported

- If required, tap the calendar in the **Due Date** field and then select the date the plan is due.
- If required, from the **Send To** drop-down list, select the lab to which the scan should be sent, or your own chairside software.

- In the **Tooth Diagram** area, select each tooth to be implanted and select **Implant Position** from the drop-down list.

If you selected **Surgical Guide Tooth Supported** as the procedure type, you can also select each supporting tooth and then select **Supporting Tooth** from the drop-down list. Supporting teeth are displayed in the **Tooth Diagram** area with a line under them.

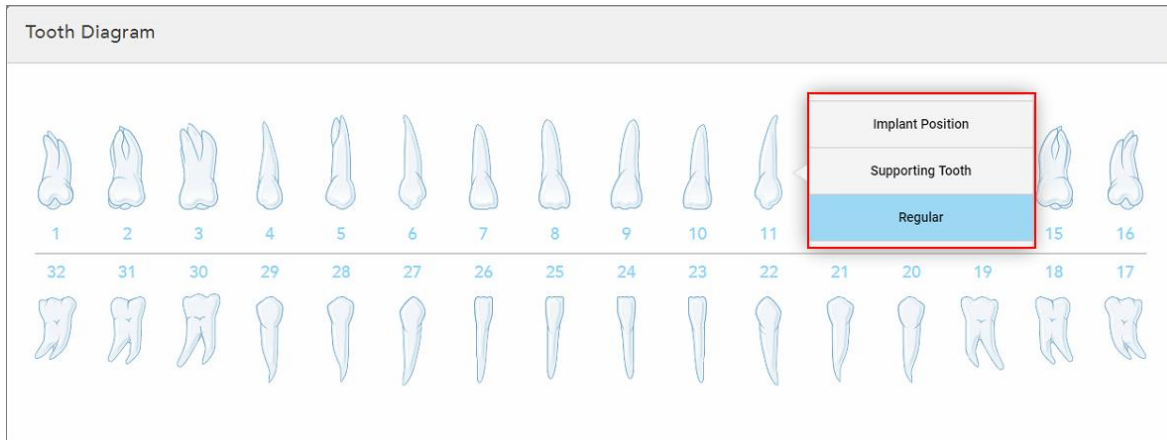

Figure 96: Defining the teeth that need to be implanted

For each tooth selected to be implanted, the *Implant Position* window is displayed.

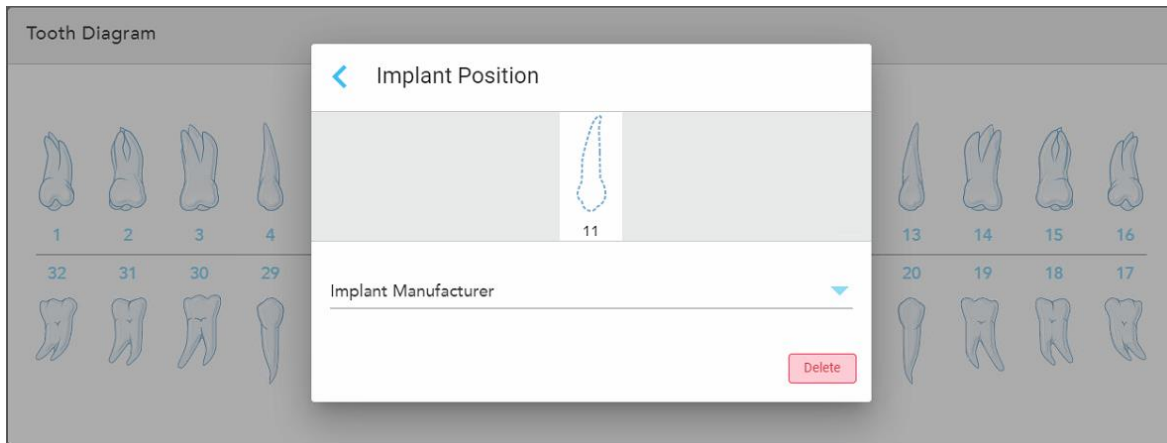



Figure 97: Implant Position window

- Select the implant manufacturer from the drop-down list.
- Tap  to save your changes and return to the *New Scan* window.

The teeth to be implanted and the supporting teeth, if relevant, are displayed in the **Tooth Diagram** area. Supporting teeth have a line under them and the teeth to be implanted are shown with a dotted line.

The details of each relevant tooth are displayed in the *Treatment Information* area below the **Tooth Diagram** area.

Tooth Diagram

Treatment Information

Tooth No.	Treatment	Specification	Material	Shade Body
8	Supporting Tooth	-	-	Show Details
9	Implant Position	-	-	Show Details
10	Implant Position	-	-	Show Details
11	Implant Position	-	-	Show Details
12	Supporting Tooth	-	-	Show Details

Figure 98: Supporting teeth and teeth to be implanted displayed in the Tooth Diagram and Treatment Information areas

- In the **Notes** area, if required, enter any specific notes to the lab regarding the patient’s treatment. For example, special instructions for delivery or manufacturing. Tap anywhere outside the **Notes** area to add the note. Each note shows the author of the note, with a timestamp, and can be edited and deleted.

5.3.5 Filling in the Rx for Denture/Removable procedures

The Denture/Removable procedure enables comprehensive planning and fabrication of partial and full dentures.

Note: Some fields are not mandatory before scanning the patient but must be filled in before you can send the scan.

To fill in the Rx for a Denture/Removable procedure:

- In the **Patient** area, enter a patient's details or search for an existing patient, as described in [Searching for existing patients](#).
- In the **Order** area, select **Denture/Removable** from the **Procedure** drop-down list.

- From the **Type** drop-down list, select the type of denture required.

The screenshot shows a form titled "Order:" with several sections. The "Procedure" section has a dropdown menu set to "Denture/Removable" and a "Due Date" field with a calendar icon. The "Denture Details:" section includes a "Stage" dropdown, a "Mould" dropdown, a "Teeth Shade" dropdown, and a "Gingival" dropdown. At the bottom, there are two toggle switches for "Upper Denture" and "Lower Denture". A red box highlights the "Type" dropdown menu, which is open and shows four options: "Partial Denture/Framework", "Immediate Denture", "Full Denture Tissue Based", and "Full Denture Implant Based".

Figure 99: Denture/Removable procedure types

- If required, tap the calendar in the **Due Date** field and then select the date the denture is due from the lab.
- If required, from the **Send To** drop-down list, select the lab to which the scan should be sent, or your own chairside software.
- If required, in the **Denture Details** area, select the denture stage (relevant only for full tissue-based and full implant-based procedure types), mould, and shade system, including the teeth shade and the gingiva shade from the relevant drop-down lists.

Upper/Lower Denture: The relevant arch toggle turns on automatically according to the tooth indications in the **Tooth Diagram** area.

- In the **Scan Options** area, turn on/off the following toggles, as required.
- In the **Tooth Diagram** area, define the teeth to be included in the denture according to the procedure type selected. This area is not relevant for Full Denture Tissue Based procedure types.

The screenshot shows a "Tooth Diagram" area with a grid of 32 tooth outlines, numbered 1 to 32. The top row contains teeth 1 through 16, and the bottom row contains teeth 32 through 17. A red box highlights a dropdown menu for tooth 11, which is currently set to "Implant Based" and has "Missing" visible below it.

Figure 100: Defining the teeth to be included in the denture – Full Denture Implant Based procedure type

- Partial Denture/Framework – Tap each relevant tooth and select either **Clasp** or **Missing**.
- Immediate Denture – Tap each relevant tooth and select either **Clasp** or **To Be Removed**.
- Full Denture Implant Based – Tap each relevant tooth and select either **Implant Based** or **Missing**. If you select **Implant Based**, the *Implant Based* settings window is displayed, with all fields mandatory.

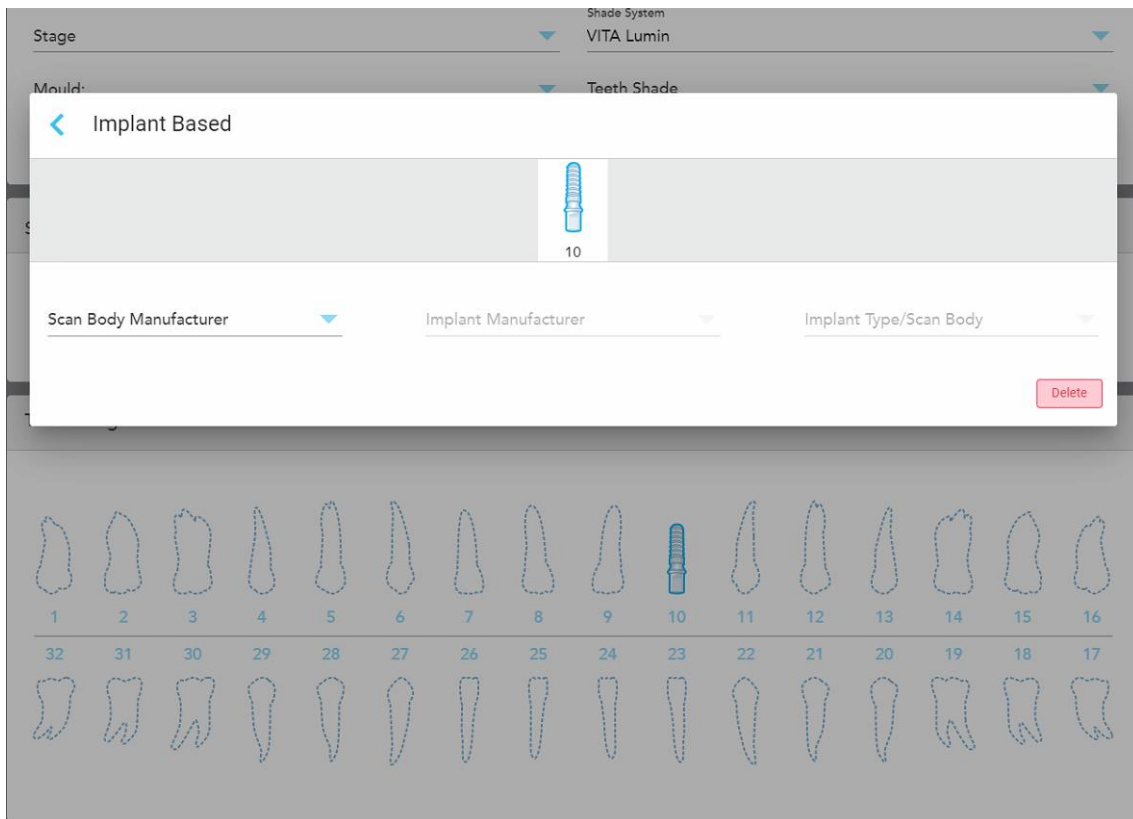



Figure 101: Implant Based settings window

- For each Implant-based tooth, select the scan body manufacturer, the implant manufacturer, and the implant type/scan body from the relevant drop-down lists.
 - Tap  to save your changes and return to the *New Scan* window.
- The **Treatment Information** area displays all indications for each tooth. If required, edit the details for each tooth by tapping **Show Details**.
 - In the **Notes** area, if required, enter any specific notes to the lab regarding the patient's treatment. For example, special instructions for delivery or manufacturing. Tap anywhere outside the **Notes** area to add the note. Each note shows the author of the note, with a timestamp, and can be edited and deleted.

11. Tap  on the toolbar to move to Scan mode, as described in [Scanning the patient](#).

Note: Excess soft tissue will not be removed automatically from around the edges of the model during scanning. If required, you can enable automatic cleanup by pressing on the screen and then tapping the Auto Cleanup tool. For more information, see [Disabling auto-cleanup](#).

5.3.6 Filling in the Rx for Appliance procedures

The Appliance procedure enables you to create a prescription for various dental appliances, such as night guards and sleep appliances.

To fill in the Rx for an Appliance procedure:

1. In the **Patient** area, enter a patient's details or search for an existing patient, as described in [Searching for existing patients](#).
2. In the **Order** area, select **Appliance** from the **Procedure** drop-down list.
3. From the **Type** drop-down list, select the type of appliance required. If the required appliance is not listed, select **Ortho Appliance** and then enter your requirements in the **Notes** area at the bottom of the window.

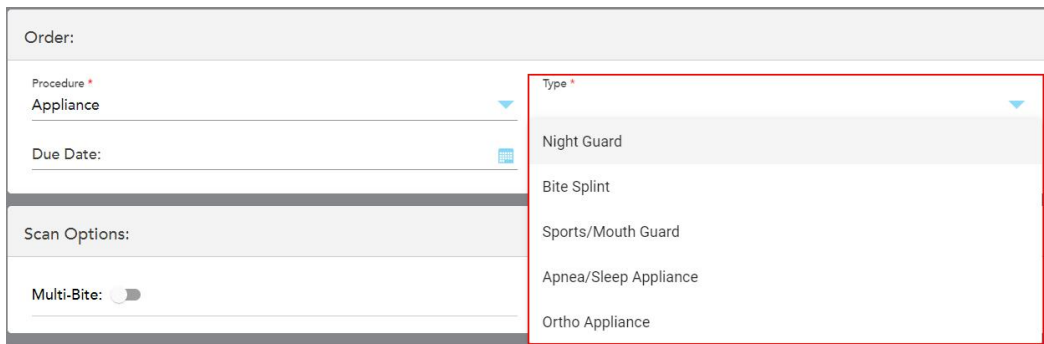

The screenshot displays the 'Order' section of the software interface. It features a 'Procedure' dropdown menu currently set to 'Appliance'. Below it is a 'Due Date' field with a calendar icon. To the right, a 'Type' dropdown menu is open, listing five options: 'Night Guard', 'Bite Splint', 'Sports/Mouth Guard', 'Apnea/Sleep Appliance', and 'Ortho Appliance'. Below the 'Order' section is the 'Scan Options' section, which includes a 'Multi-Bite' toggle switch.

Figure 102: Appliance procedure types

4. Continue filling in the prescription from step 5, as described in [Filling in the Rx](#).

5.4 Patient management

You control the patient's data-management process from the **Patient** area in the *New Scan* window.

- Add a new patient, as described in [Adding new patients](#)
- Search for an existing patient, as described in [Searching for existing patients](#)
- Edit a patient's details, as described in [Editing the patient details](#)
- Clear the patient data from the *New Scan* window, as described in [Clearing the patient details from the New Scan window](#)

5.4.1 Adding new patients

You can add a new patient while filling in the Rx. The patient's details will be saved once you move to the *Scan* window and can later be edited, as described in [Editing the patient details](#).

In addition, you can add new patients using MyiTero or your Dental Program Management Services (DPMS) software.

To add a new patient:

1. In the *New Scan* window, in the **Patient** area, enter the patient's first name and last name.
2. If required, enter the patient's date of birth in DD/MM/YYYY format, select the patient's gender, and enter a unique identifier as the patient's chart number.

The new patient's details are displayed in the **Patient** area of the *New Scan* window.

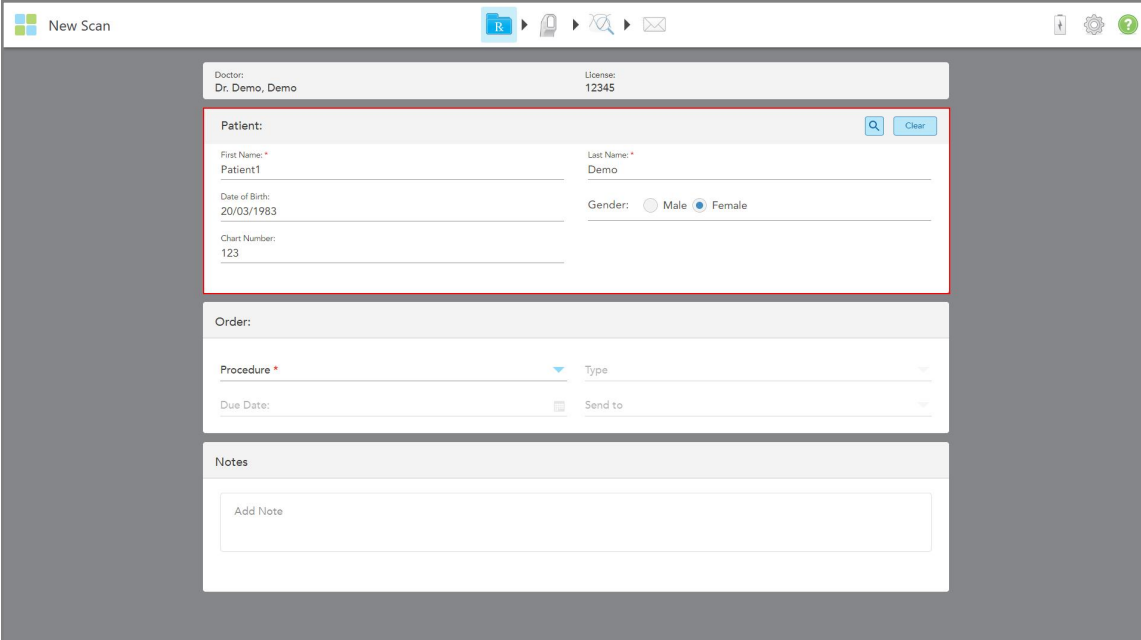

The screenshot shows the 'New Scan' window with a patient form. The form is divided into sections: Doctor, Patient, Order, and Notes. The Patient section is highlighted with a red border. The Patient section contains the following fields: First Name (Patient1), Last Name (Demo), Date of Birth (20/03/1983), Chart Number (123), and Gender (Male, Female). The Order section contains Procedure, Type, Due Date, and Send to. The Notes section contains an 'Add Note' button.

Figure 103: Adding a new patient

Note: If you try adding a patient who already exists, the **First Name**, **Last Name**, and **Chart Number** fields are highlighted, and a message is displayed notifying you that a patient with the same details already exists.

The screenshot shows a 'Patient' form with the following fields: First Name (*), Last Name (*), Date of Birth, Gender (Male/Female), and Chart Number. The 'First Name' field contains 'Patient2', 'Last Name' contains 'Demo', and 'Chart Number' is empty. All three fields are highlighted with a red underline. A yellow message box at the bottom states: 'A patient with the same details already exists: Demo, Patient2. Load existing patient or edit highlighted fields above to create a new patient.' There are search and clear buttons in the top right corner.

Figure 104: Message notifying that a patient with the same details exists

- If the new patient and the existing patient are the same person, tap **Load existing patient**.
- If the new patient and the existing patient are different people, edit the highlighted fields – First Name, Last Name, or Chart Number – to create a new patient.

The patient's details are displayed in the *New Scan* window.

5.4.2 Searching for existing patients

When searching for an existing patient, you must enter at least 3 characters of the patient's name in the search field to see a list of patients who match the search criteria.

In addition, you can search for a patient from the **Patients** page, described in [Searching for patients](#).

To search for an existing patient:

- In the *New Scan* window, in the **Patient** area, tap .

The screenshot shows the 'Patient' form from the 'New Scan' window. The search icon in the top right corner is highlighted with a red square. The form fields are: First Name (*), Last Name (*), Date of Birth, Gender (Male/Female), and Chart Number. The search and clear buttons are visible in the top right.

Figure 105: Patient area of the New Scan window – searching for an existing patient

The *Search Patient* window is displayed.

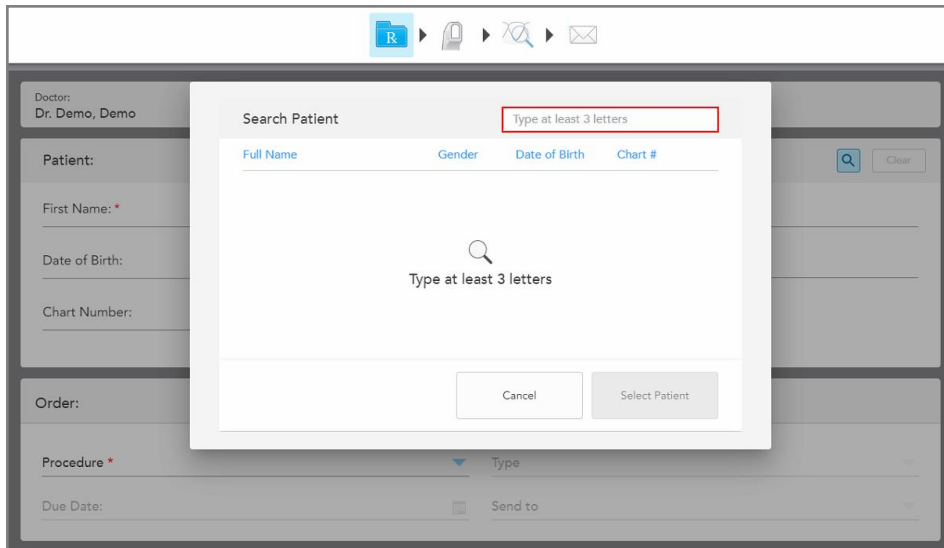

Figure 106: Search Patient window with a search field

- In the *Search Patient* window, enter at least three letters in the search field to display a list of patients matching the search criteria.

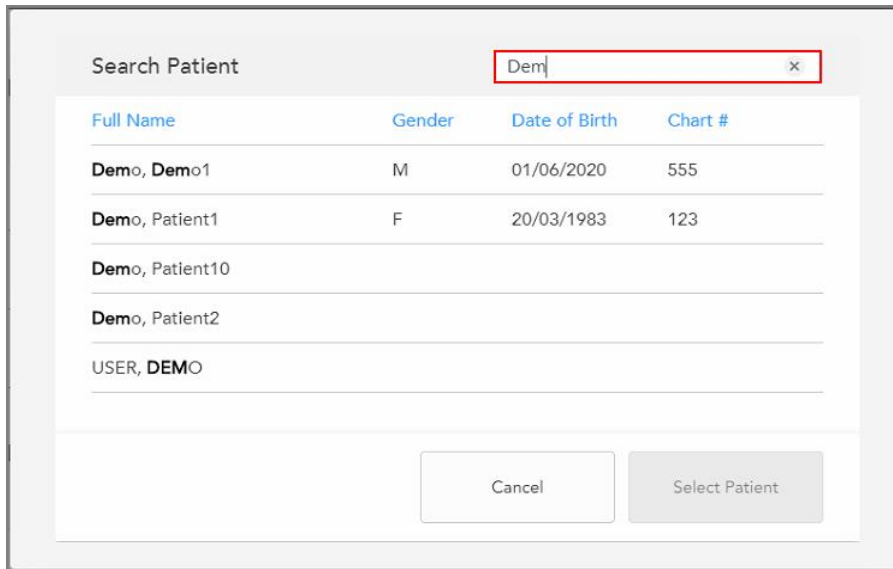

Figure 107: Search criteria in the search field and list of matching patients

3. Select the required patient, and then tap **Select Patient**.

Full Name	Gender	Date of Birth	Chart #
Demo, Demo1	M	01/06/2020	555
Demo, Patient1	F	20/03/1983	123
Demo, Patient10			
Demo, Patient2			
USER, DEMO			

Figure 108: Selecting the required patient

The selected patient is displayed in the **Patient** area of the *New Scan* window.

Doctor: Dr. Demo, Demo License: 12345

Patient: ✎ Clear

First Name: Patient1 Last Name: Demo

Date of Birth: 20/03/1983 Gender: Male Female

Chart Number: 123

Figure 109: Selected patient displayed in the Patient area of the New Scan window

5.4.3 Editing the patient details

After you have searched for and selected a patient, or after you have added a new patient, you can edit the patient's details.

In addition, you can edit the patient's details when opening the Rx from the patient's profile page, as described in [Viewing the Rx](#).

To edit a patient's details:

1. Search for an existing patient, as described in [Searching for existing patients](#).

The patient is displayed in the *New Scan* window.

2. In the **Patient** area, tap .

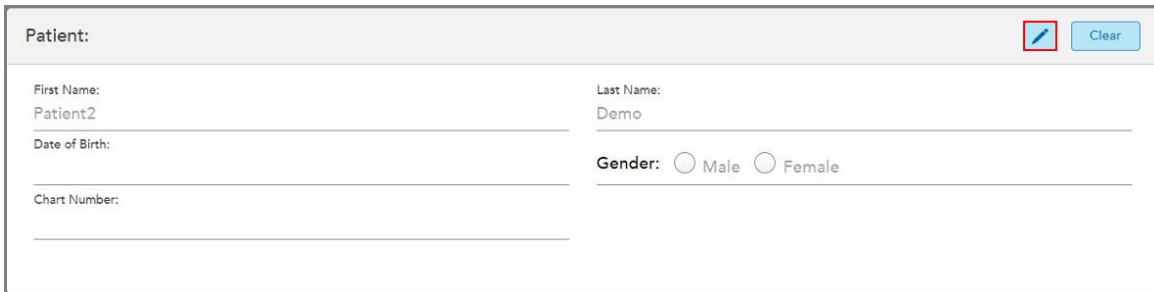

Patient: 

First Name: Patient2
Last Name: Demo

Date of Birth: _____ Gender: Male Female

Chart Number: _____

Figure 110: Patient area of New Scan window – editing a patient

The *Edit Patient* window is displayed.

3. Edit the patient's details as required and then tap **Update**.

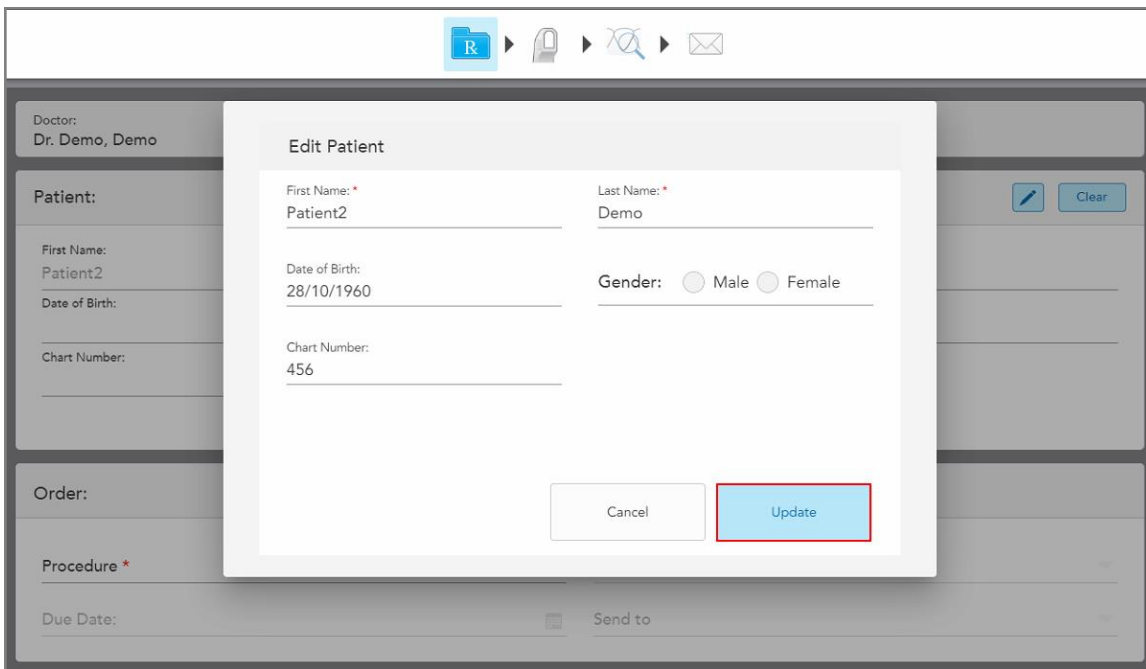

Doctor: Dr. Demo, Demo

Patient: 

First Name: Patient2
Last Name: Demo

Date of Birth: 28/10/1960
Gender: Male Female

Chart Number: 456

Order: _____

Procedure * _____

Due Date: _____

Cancel

Figure 111: Edit Patient window and Update button

If, while editing the patient's name, you enter the same details as an existing patient, a message is displayed notifying you of such.

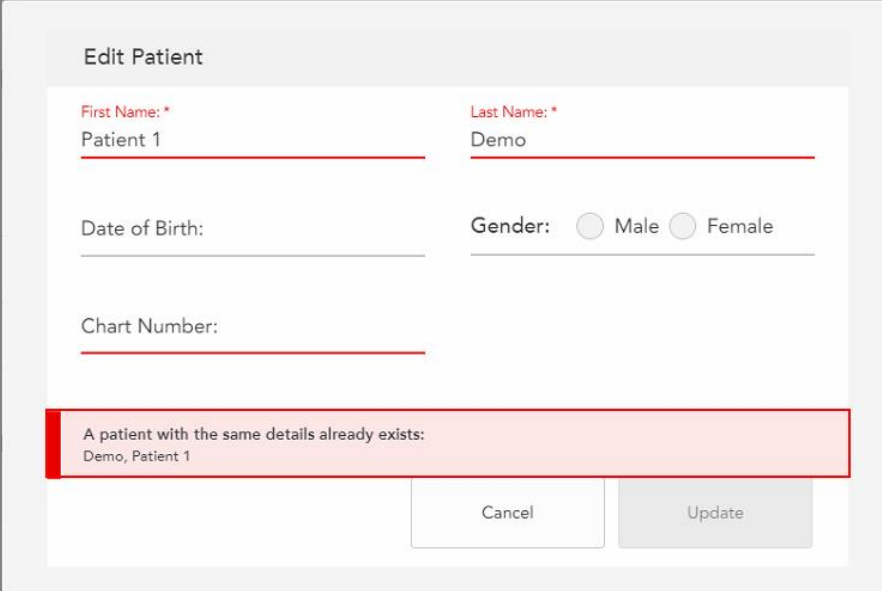

The screenshot shows the 'Edit Patient' form with the following fields: 'First Name: *' (Patient 1), 'Last Name: *' (Demo), 'Date of Birth:', 'Gender: Male Female', and 'Chart Number:'. A red message box at the bottom states: 'A patient with the same details already exists: Demo, Patient 1'. There are 'Cancel' and 'Update' buttons at the bottom right.

Figure 112: Message that a patient with the same details already exists

To differentiate between patients with the same details, enter a unique identifier in the **Chart Number** field.

5.4.4 Clearing the patient details from the New Scan window

If required, you can remove the currently-displayed patient's details from the *New Scan* window.

To clear the patient details from the New Scan window:

1. In the **Patient** area, tap .

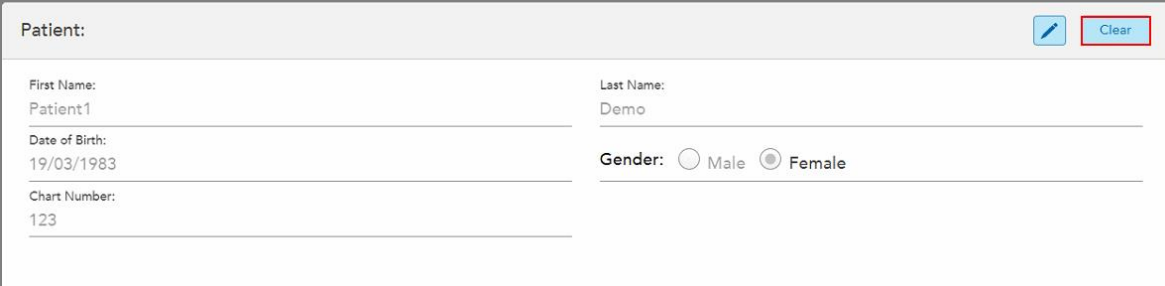

The screenshot shows the 'Patient' form with the following fields: 'First Name: Patient1', 'Last Name: Demo', 'Date of Birth: 19/03/1983', 'Gender: Male Female', and 'Chart Number: 123'. A 'Clear' button is highlighted in red in the top right corner.

Figure 113: Clear patient details button

A confirmation message is displayed.

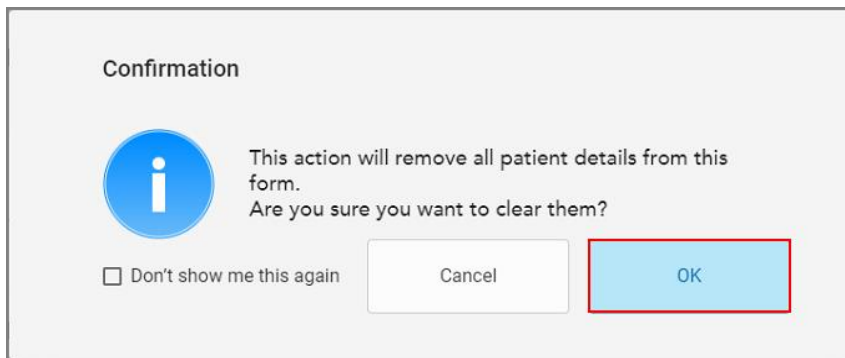



Figure 114: Clear confirmation message

2. Tap **OK** to clear the patient's details.

If required, you can select the **Don't show me this again** check box. In the future, the patient details will be cleared from the *New Scan* window as soon as you tap the **Clear** button.

All data is cleared from the *New Scan* window, and you can now add a new patient or search for an existing patient, if required.

5.5 Scanning the patient

After you have filled in the Rx, tap  on the toolbar to enter Scan mode. The *Scan* window is displayed, enabling you to start scanning the patient.

While in Scan mode, you can perform the following actions:

- View additional scan feedback, described in [Additional scan feedback](#)
- Toggle between color and monochrome mode, described in [Scan color toggle](#)

You can also edit the scan, as follows:

- Delete a segment, as described in [Deleting a segment](#)
- Delete a selected area, as described in [Deleting a selection](#)
- Capture areas with missing anatomy, as described in [Filling in missing anatomy](#)
- Display the excess tissue around the edges of the 3D model, as described in [Disabling auto-cleanup](#)

When you have finished scanning the patient, tap  on the toolbar to move to **View** mode, where you can review the scan.

5.5.1 Scanning guidance

As soon as you move to Scan mode, the recommended scanning sequence for the selected scan segment is displayed in the center of the scanner window. It will automatically disappear after a short while, or you can tap anywhere on the screen to hide it.

iTerо recommends you follow the scanning sequence for best results.

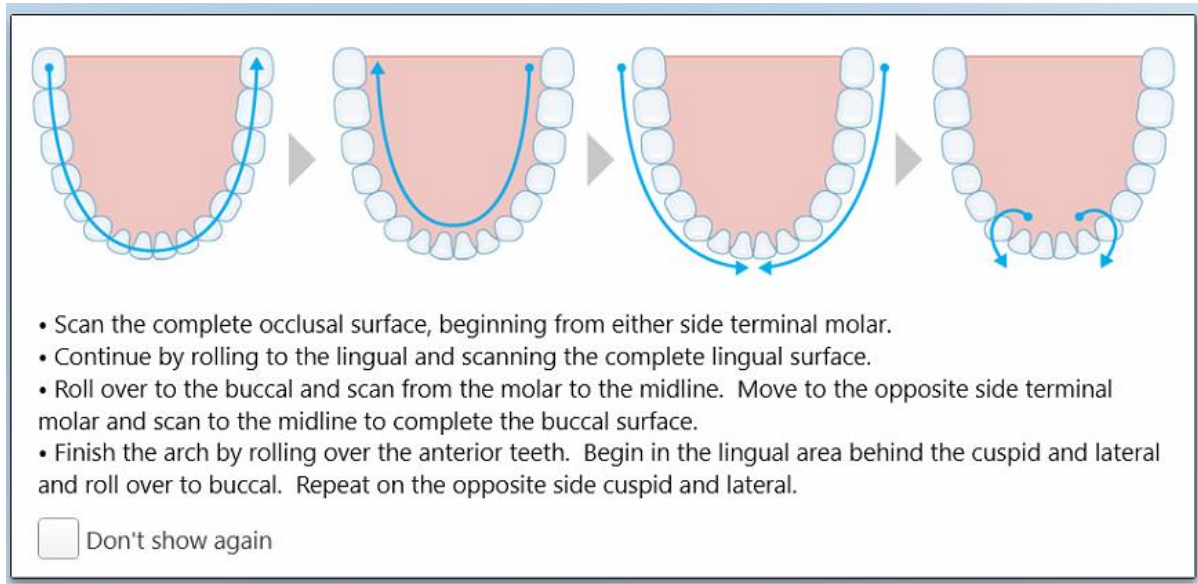

Figure 115: Recommended scanning sequence – lower jaw

Note: If you select the **Don't show again** check box, this guidance will not be displayed in future scans. You can return the guidance by enabling it in the **Scan** settings, as described in [Defining the scan settings](#).

In addition, if you press both wand buttons simultaneously, the following guidance is displayed:

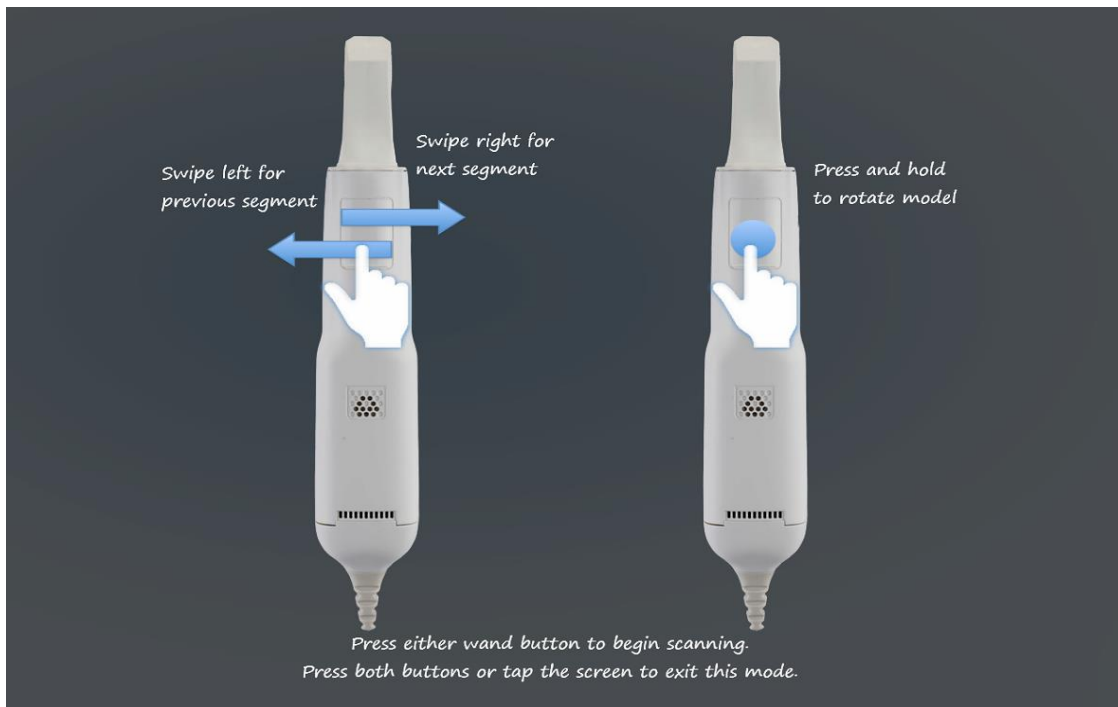

Figure 116: Wand guidance

Press either of the wand buttons to begin scanning.

5.5.2 Scanning best practices

iTero recommends the following best practices for scanning fixed restorative procedures:

- Ensure that the prepped tooth and the surrounding area are free of debris, saliva, and blood contamination.
- The prepped tooth should be dry, and the margin line should be clear of tissue.
- You should be familiar with proper scanning techniques and avoid over scanning.

5.5.3 Scan options

In Scan mode, you can select the following options:

- Additional scan feedback, described in [Additional scan feedback](#)
- Toggle color/monochrome, described in [Scan color toggle](#)
- Edit the scan:
 - Delete a segment, described in [Deleting a segment](#)
 - Delete a selection, described in [Deleting a selection](#)
 - Fill in missing anatomy, described in [Filling in missing anatomy](#)
 - Disable auto cleanup, described in [Disabling auto-cleanup](#)

5.5.3.1 Additional scan feedback



You can activate the additional scan feedback mode  to alert you to the areas that need additional scanning, to ensure that critical areas that could compromise the whole model are not missed.

Areas with missing anatomy are highlighted in red when scanning in monochromatic mode, and purple when scanning in color mode.

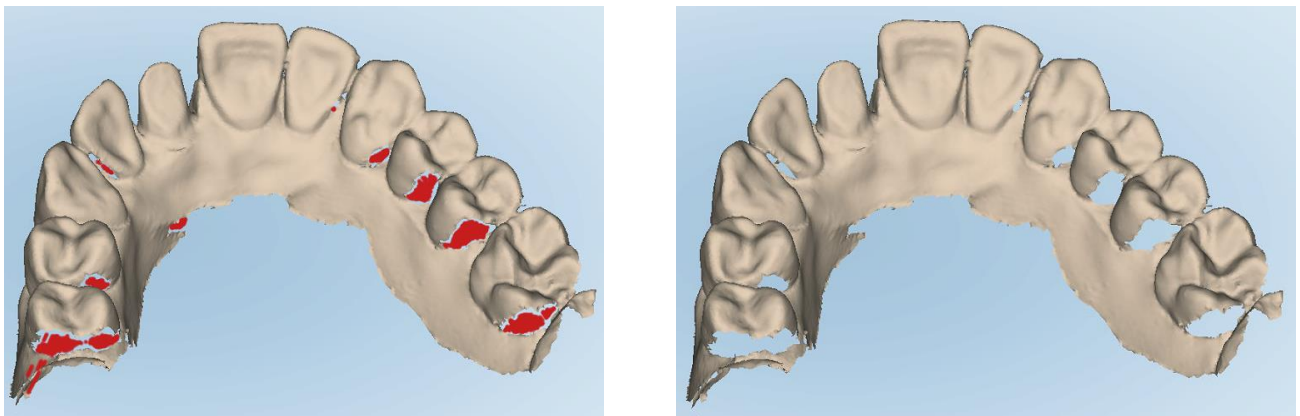

Figure 117: Areas with missing anatomy shown with and without additional scan feedback – monochrome

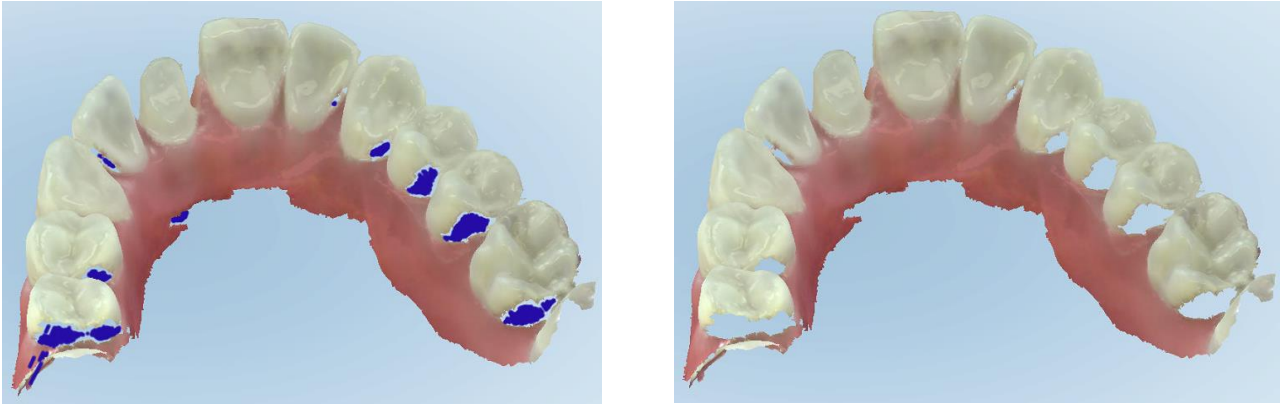



Figure 118: Areas with missing anatomy shown with and without additional scan feedback – color mode

By default, this mode is enabled, but it can be disabled per case by tapping  or by default in the Scan settings, as described in [Defining the scan settings](#).

5.5.3.2 Scan color toggle

The color toggle button  allows you to toggle between color and monochromatic modes. This applies to both scanning and viewing all procedures.

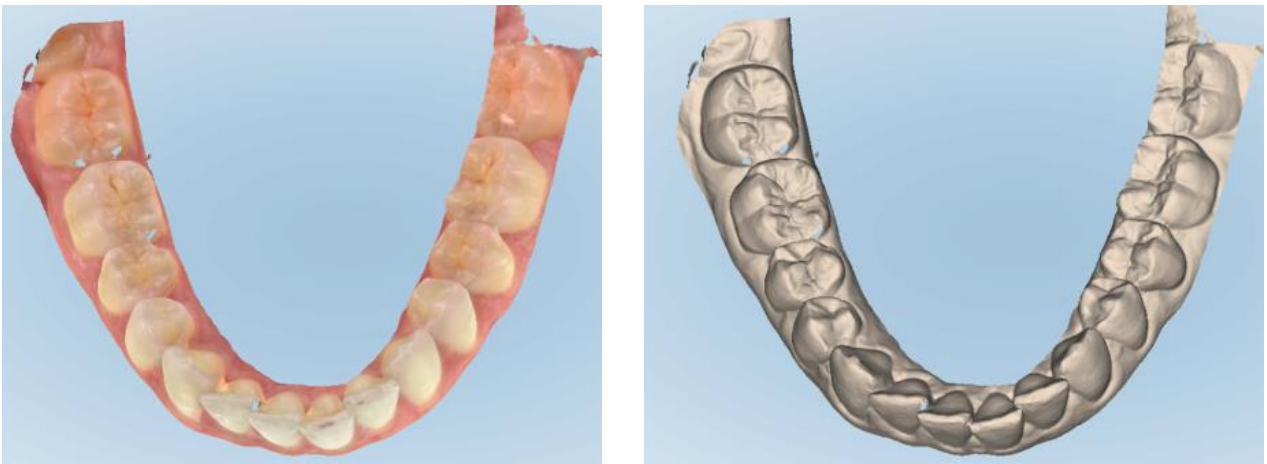



Figure 119: Model displayed in color and monochrome mode

By default, models are scanned in color, but you can toggle the display per case by tapping  or by default in the Scan settings, as described in [Defining the scan settings](#).

5.5.3.3 Switching to the next scan segment

During scanning, the current segment is highlighted in blue in the navigation controls, and also displayed in the segment indicator box, between the arrows.

Note: Before moving to the next segment, press either of the wand side buttons to stop the wand from scanning. The system emits a sound when stopping the scan and again when restarting the scan.

You can move to the next segment by:

- Tapping on the relevant arch, prepped tooth, or bite segment
- Tapping the arrows

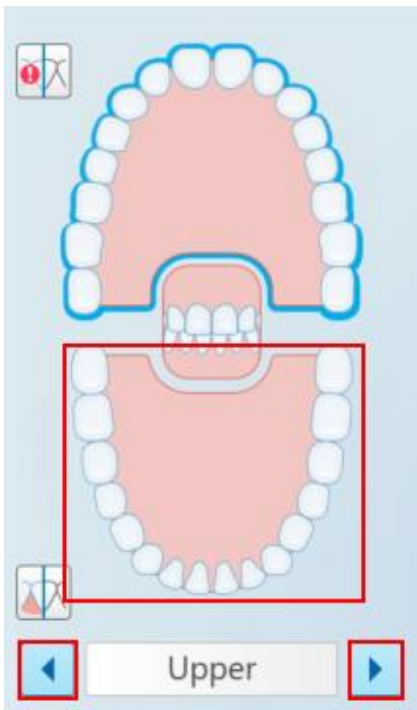

Figure 120: Tap the opposite arch or tap the arrows to select it

- Swiping to the left or the right on the wand touchpad.
To enable the wand touchpad, press and release both wand buttons simultaneously.

5.5.4 Editing a scan

After you have scanned the model, you can edit it using the following tools:

- Delete Segment tool, described in [Deleting a segment](#)
- Delete Selection tool, described in [Deleting a selection](#)
- Fill tool, described in [Filling in missing anatomy](#)
- Disable auto-cleanup tool, described in [Disabling auto-cleanup](#)

The editing tools are accessed by pressing on the screen.

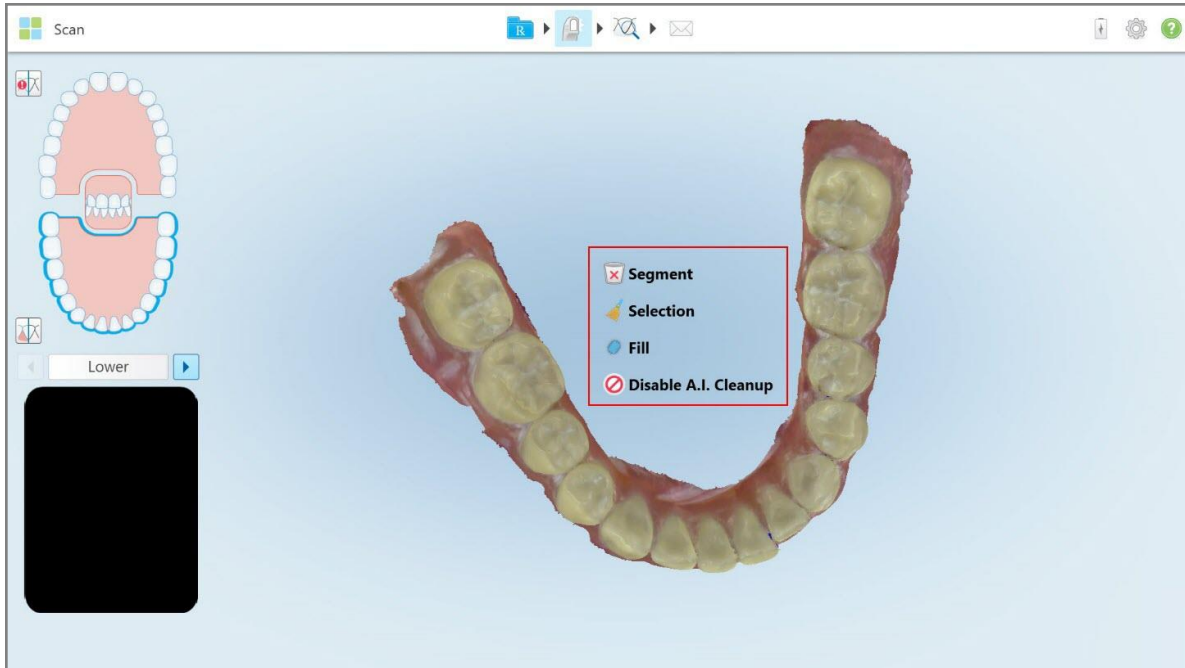



Figure 121: Editing tools

5.6 Viewing the scan

After scanning the patient, tap  to move to View mode. After the post-processing stage is complete, you can inspect the model in high resolution to ensure that sufficient anatomy has been captured, and that the model is accurate and complete.

If there are missing scan segments or missing bites, a message will be displayed at the beginning of the post-processing stage notifying you of this and enabling you to go back and add the missing areas of the scan. For more information, see [Missing scan segment notifications](#).

While viewing the scan, you can:

- Delete selected areas of a scan, as described in [Working with the Eraser tool](#)
- Manually create the die separation if the green hint point was not on the center of the prepped tooth during scanning, as described in [Working with the Die Separation tool](#)
- Define the margin line, as described in [Working with the Margin Line tool](#)
- Capture a screenshot of the model, as described in [Working with the Snapshot tool](#)

After you have reviewed the scan to ensure that it is complete, tap  on the toolbar to send the scan to the lab or your chairside software, as described in [Sending the scan](#).

Note for Fixed Restorative and Denture/Removable procedures: After viewing the scan, return to the *New Scan* window to fill in any mandatory fields that were not filled in. These fields were not mandatory when scanning the patient but must be filled in before sending the scan. If there are missing fields when sending the scan, a message is displayed, prompting you to fill in all mandatory fields highlighted in red in the **Treatment Information** area.

5.6.1 Missing scan segment notifications

If there are missing scan segments or bite scans when you tap the  button, you will be notified at the beginning of the post-processing stage, and you will be able to go back and add the missing areas of the scan, in order to reduce manual intervention later on.

Notifications are displayed in the following cases:

- Missing prep or arch – segments were not scanned or not stitched together properly
- Bite issues
- Missing bite
- Bite scanned from one side only
- Discrepancy between the left and the right bite scans

In addition, the bite section in the navigation controls is highlighted in red.

The message may be generic, or very specific to the issue including guidance on how to correct the issue. In some cases, you may be warned that the scan may be returned from the lab if you do not fix the issues.

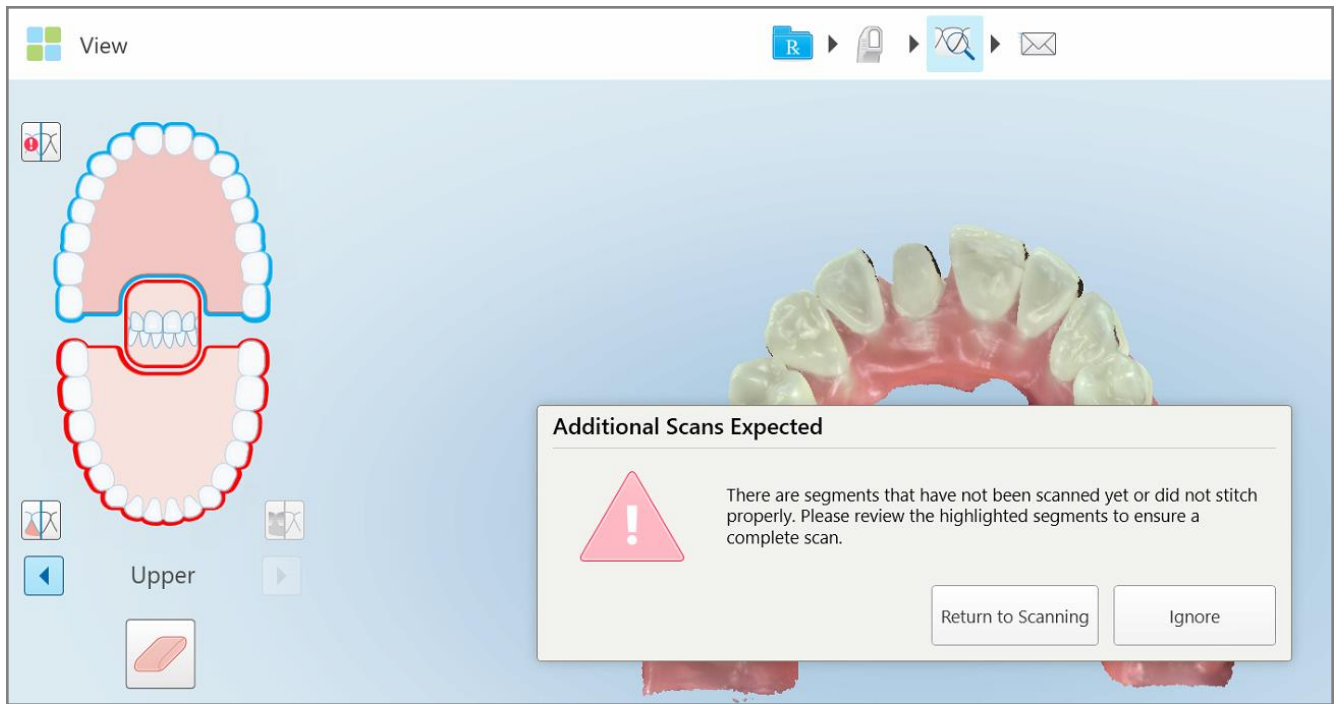



Figure 122: Missing scan message and missing segments highlighted in red

You can tap **Return to Scanning** to go back to Scan mode and rescan the missing segments, which are highlighted in red in the navigation controls.

5.6.2 Using the scan timer

The scan timer enables you to see how long it took to scan the model.

To view the scan time:

1. On the toolbar, tap the  button.

The scan time is displayed.



Figure 123: Scan timer button on the toolbar and scan time

2. Tap **OK** to close the window.

5.7 Sending the scan

After you have scanned the patient and reviewed the Rx to ensure that no data is missing, you can send the scan to the lab, chairside milling, or to storage, depending on the procedure.

Note: Before you can send the scan, you have to confirm that you have received the patient's consent to have their health data collected and processed by Align.

To send the scan:

1. Tap  on the toolbar to send the scan, including screenshots of the scanned model, if relevant.

Note for Fixed Restorative and Denture/Removable procedures: Some fields in the Rx become mandatory only after the patient has been scanned. If you have not completed all the mandatory information required, a message is displayed prompting you to fill in the missing fields.

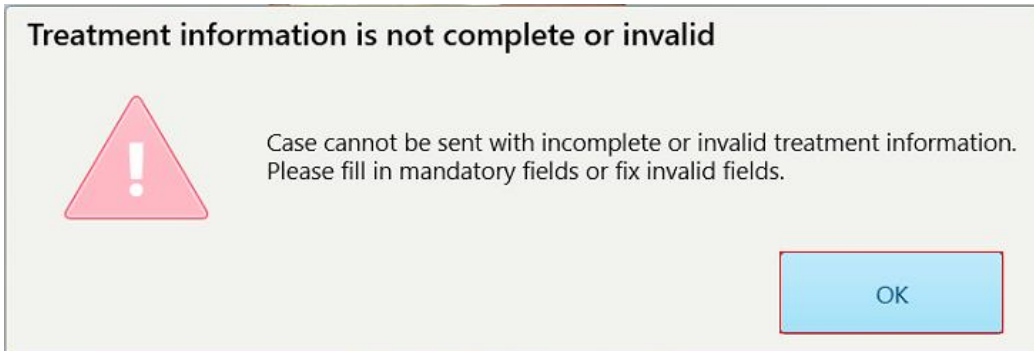

Figure 124: Notification about missing treatment information

- a. Tap **OK** to display the *Rx Details* page, showing a notification in the **Treatment Information** area for each treatment missing required fields.

Treatment Information					
Bridge : 14 - 16					
Tooth No.	Treatment	Specification	Material	Shade Body	
14	Implant Based	-	-	-	Show Details
Required Fields are Missing for Treatment					
15	Pontic	-	-	-	Show Details
Required Fields are Missing for Treatment					
16	Implant Based	-	-	-	Show Details
Required Fields are Missing for Treatment					

Figure 125: Missing fields highlighted in red in the Treatment Information area

- b. Tap **Show Details** to open the treatment options and fill in the missing details.

- c. Tap  to send the scan.

The *Send Confirmation* window is displayed.

2. Sign in the **Signature** area to authorize the order.

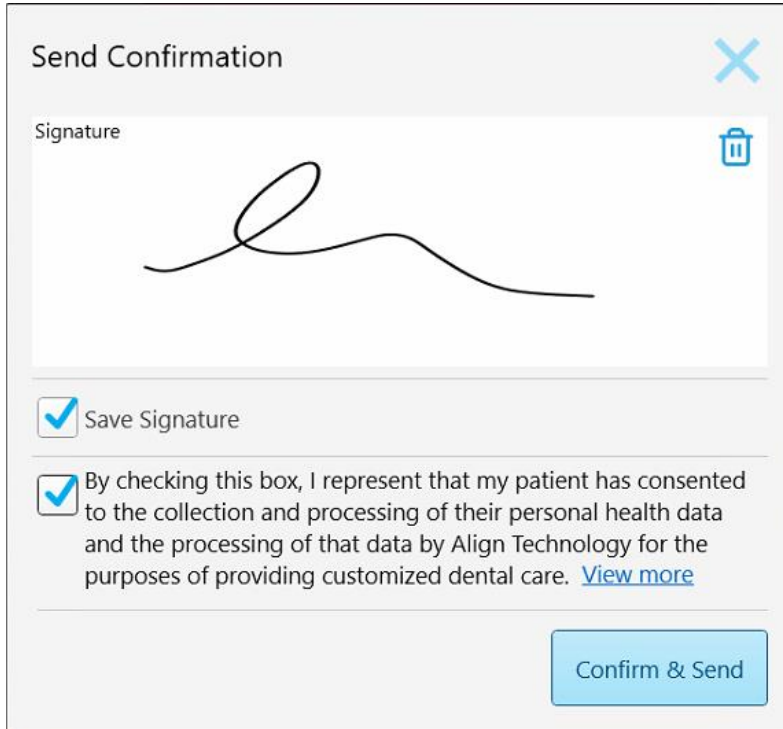

Send Confirmation

Signature

Save Signature

By checking this box, I represent that my patient has consented to the collection and processing of their personal health data and the processing of that data by Align Technology for the purposes of providing customized dental care. [View more](#)

Confirm & Send

Figure 126: Send Confirmation window

3. If required, select the **Save Signature** check box to save your signature for authorizing sending future scans.
4. If you have scanned a Study Model/iRecord procedure or an Invisalign Aligners procedure type, the **Initiate Invisalign Simulator Pro** check box is displayed and selected. Keeping this option selected will trigger the simulation. For more information regarding Invisalign Outcome Simulator Pro, see [Invisalign Outcome Simulator Pro](#).

Notes:

- In order to enable the simulation, ensure that your iTerо account is paired with your Invisalign Doctor Site account.
 - Invisalign Outcome Simulator Pro is supported on iTerо Element Plus series scanners only.
5. After receiving the consent of the patient to have their data processed and sent to Align, ensure that the patient consent check box is selected.
 6. Tap **Confirm & Send** to send the scan.

A notification is displayed that the model is being sent and then the patient's profile page is displayed showing the status of the order.

If you selected to run an Invisalign Outcome Simulator Pro simulation, the Viewer is displayed showing the progress of the simulation.

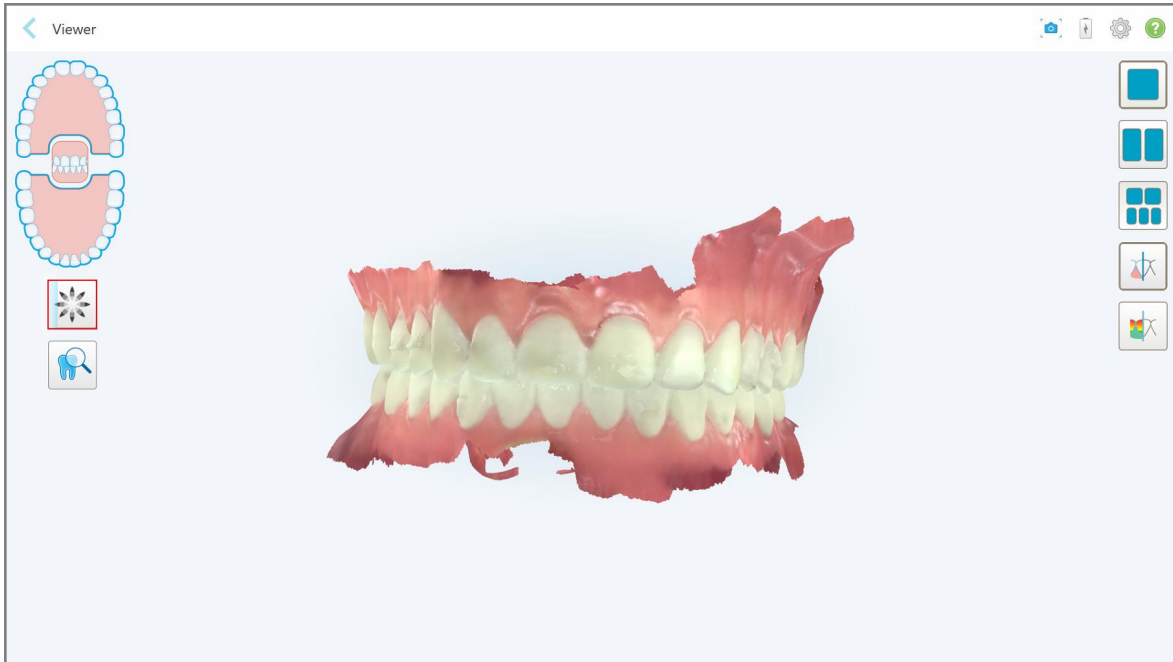

Figure 127: Invisalign Outcome Simulator Pro progress shown in the Viewer

You can also view the progress of the simulation in the patient's profile page.

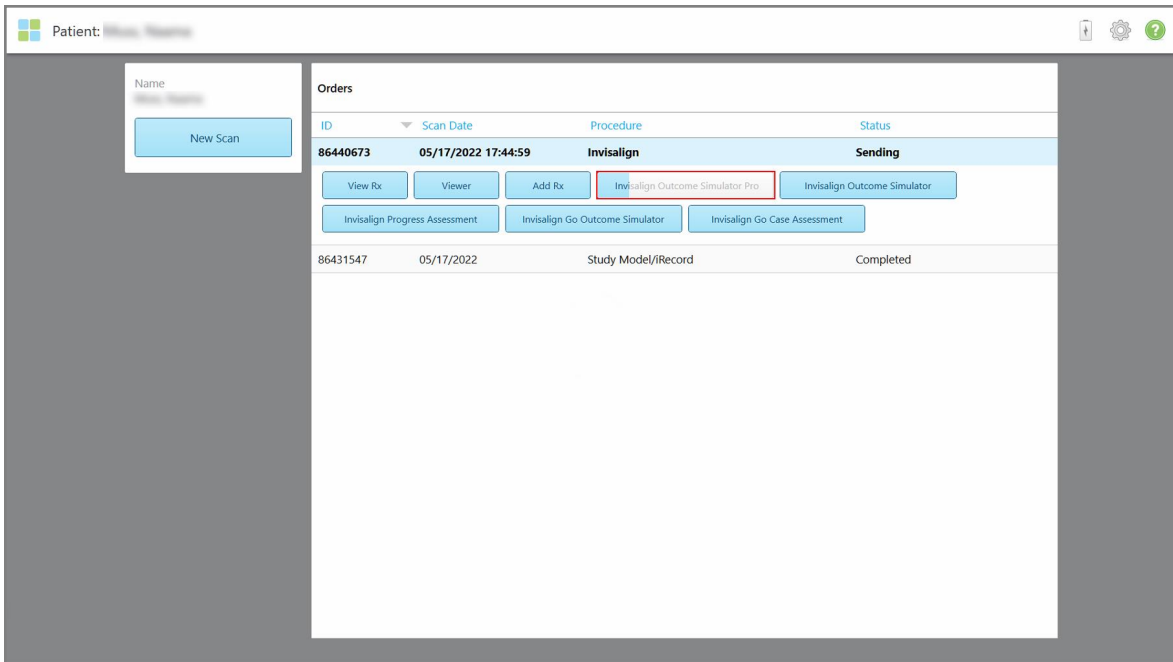

Figure 128: Invisalign Outcome Simulator Pro progress shown in the patient's profile page

If you did not select to run Invisalign Outcome Simulator Pro, a notification is displayed that the model is being sent and then the patient's profile page is displayed showing the status of the order.

5.8 Working with the Viewer

The Viewer is a tool that enables you to view and manipulate the digital model for case presentations. Only scans that have already been sent can be viewed in the Viewer.

The Viewer can be accessed from Past Orders in the *Orders* page, or from a specific patient's profile page.

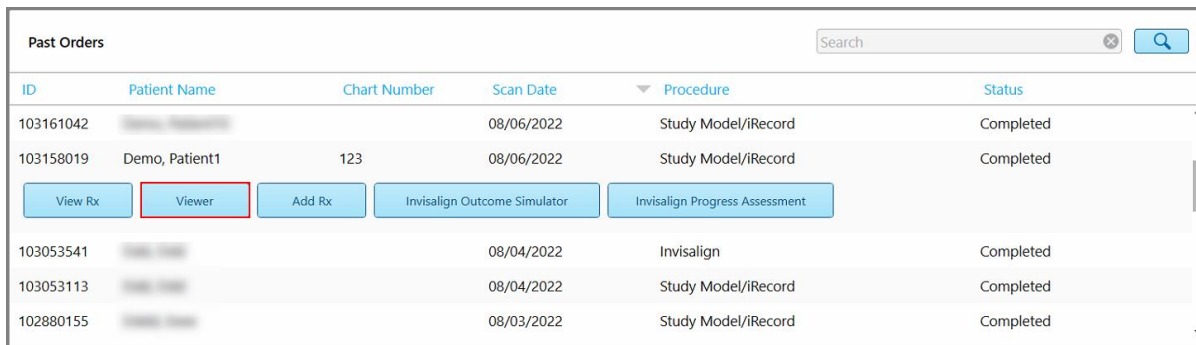

ID	Patient Name	Chart Number	Scan Date	Procedure	Status
103161042	[REDACTED]		08/06/2022	Study Model/iRecord	Completed
103158019	Demo, Patient1	123	08/06/2022	Study Model/iRecord	Completed
103053541	[REDACTED]		08/04/2022	Invisalign	Completed
103053113	[REDACTED]		08/04/2022	Study Model/iRecord	Completed
102880155	[REDACTED]		08/03/2022	Study Model/iRecord	Completed

Figure 129: Viewer option in the Past Orders pane in the Orders page

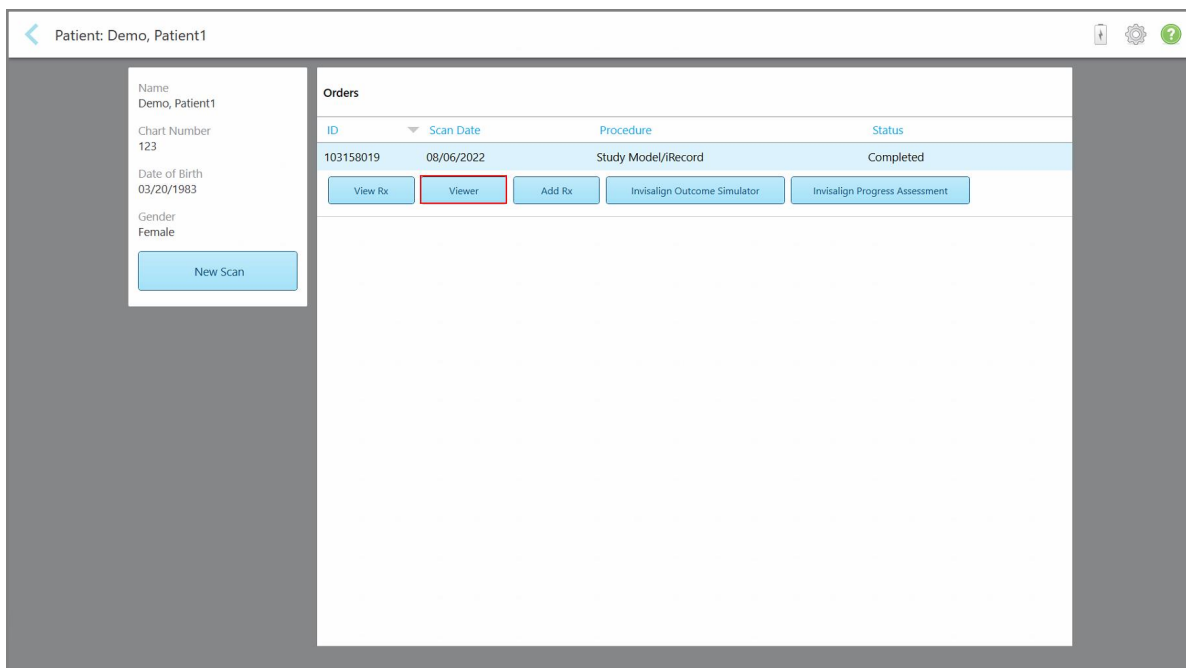

ID	Scan Date	Procedure	Status
103158019	08/06/2022	Study Model/iRecord	Completed

Figure 130: Viewer option in the patient's profile page

In the Viewer, you can tap the following to:



Show/hide the upper jaw.



Show/hide the lower jaw.



Show both jaws.



Display the Invisalign Outcome Simulator Pro tool, as described in [Invisalign Outcome Simulator Pro](#). Available only for Study Model/iRecord procedures and Invisalign Aligners procedure types.



Display the model in a 1-window view, with the upper and lower jaws in the same window (Frontal view).



Figure 131: Model in a 1-window view

Relevant for Orthodontic procedures only.



Display the model in a 2-window view, with the upper and lower jaws in separate windows (Occlusal view). Each model can be controlled separately, for better evaluation.



Figure 132: Model in a 2-window view

Relevant for Orthodontic procedures only.



Display the model in a 5-window view, with the upper and lower jaws separately, and both jaws from the left, center, and right (Gallery view). Each model can be controlled separately, for better evaluation.



Figure 133: Model in a 5-window view

Relevant for Orthodontic procedures only.



Display/hide the margin line of the prepped tooth.

Relevant for Restorative procedures only.



Show/hide the ditch created by the Modeling team. This will be enabled in the Viewer only after the modeling phase.

Relevant for Restorative procedures only.



Toggle between viewing the model in color or monochrome.



Show/hide the occlusal clearance between the opposing teeth, as described in [Working with the Occlusal Clearance tool](#). This option is enabled only if the bite was scanned.

Note: When the case status is **iTero Modeling**, it is in the early stages of modeling, and the margin line and die tools are disabled.

When the modeling process is completed, and the die and margin line have been edited, the changes appear in color on the model and the tools are displayed in color, indicating that they are active.

5.9 Removing the wand sleeve

The wand sleeves are intended for single-patient use and must be disposed of and replaced after each patient in order to avoid cross-contamination.

To remove the wand sleeve:

1. Once the scan is complete, or if the scan has been interrupted, press lightly on the center of the sleeve, slowly pull the sleeve off the wand, and discard it.

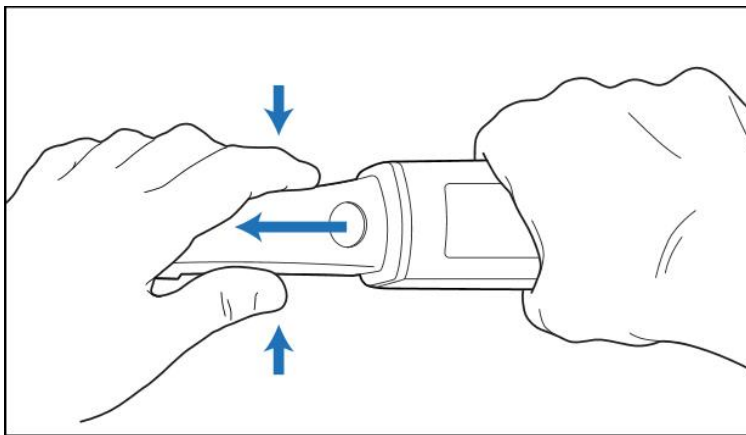

Figure 134: Removing a wand sleeve



CAUTION: Dispose of used sleeves according to standard operating procedures or local regulations for the disposal of contaminated medical waste.

CAUTION: OPTICAL SURFACE!

DO NOT touch the optical surface of the wand. Contact may cause damage. If additional cleaning, besides that listed in [Wand cleaning and disinfection](#) is necessary, use the anti-static cloth found inside the sleeve box. For more information, refer to the instructions in the box.

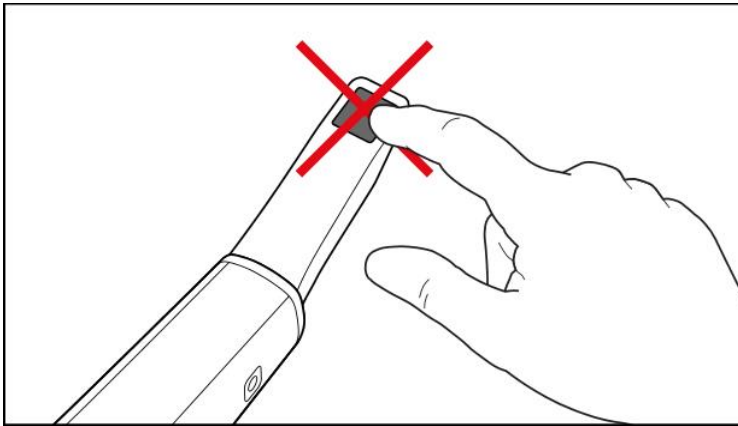

Figure 135: Optical surface of the wand

2. Clean and disinfect the wand, as described in [Cleaning and disinfecting the wand](#).
3. Gently slide a new sleeve onto the tip of the wand until it clicks into place.

Note: If the scanner will not be used immediately after cleaning and disinfection, attach the blue protective sleeve.

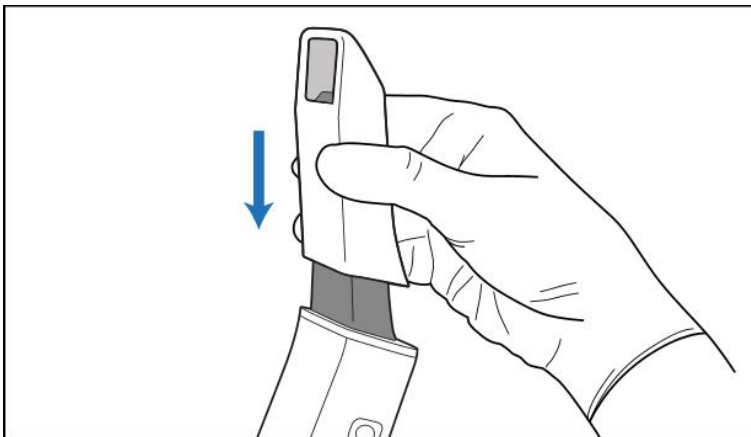

Figure 136: Gently slide the new sleeve into place

6 Working with patients

On the home screen, tap the **Patients** button to display the *Patients* page.



The *Patients* page displays a list of all patients registered in your iTero system, and if relevant, their chart number, date of birth, and the date of their last scan.

Patient Name	Chart Number	Date of Birth	Last Scan Date
[blurred]			08/04/2022
[blurred]			08/03/2022
[blurred]			07/31/2022
[blurred]			07/26/2022
[blurred]			07/25/2022
[blurred]			07/21/2022
[blurred]			07/19/2022
[blurred]			06/22/2022
[blurred]			02/15/2022
[blurred]			01/26/2022
[blurred]			11/16/2021
[blurred]			11/09/2021
[blurred]	12345	[blurred]	05/27/2021
[blurred]			04/29/2021
[blurred]			04/29/2021
[blurred]			02/07/2021

Figure 137: Patients page

Once you have selected a patient, you can view the patient's profile page with the patient's details.

6.1 Searching for patients

If required, you can search for patients in the iTero database using their names or chart numbers.

To search for a patient:

- In the *Patients* page, enter the patient's name or chart number (or part thereof) in the search field and then tap the search button .

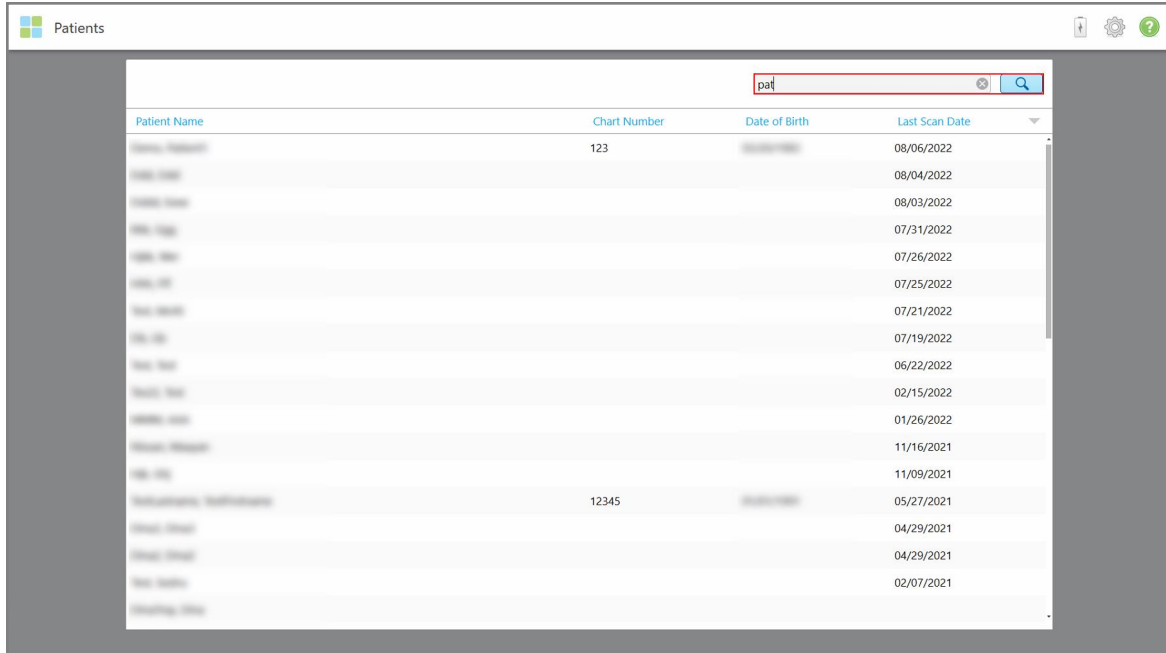
**Figure 138: Searching for a patient**

The patients that match the search criteria are displayed.

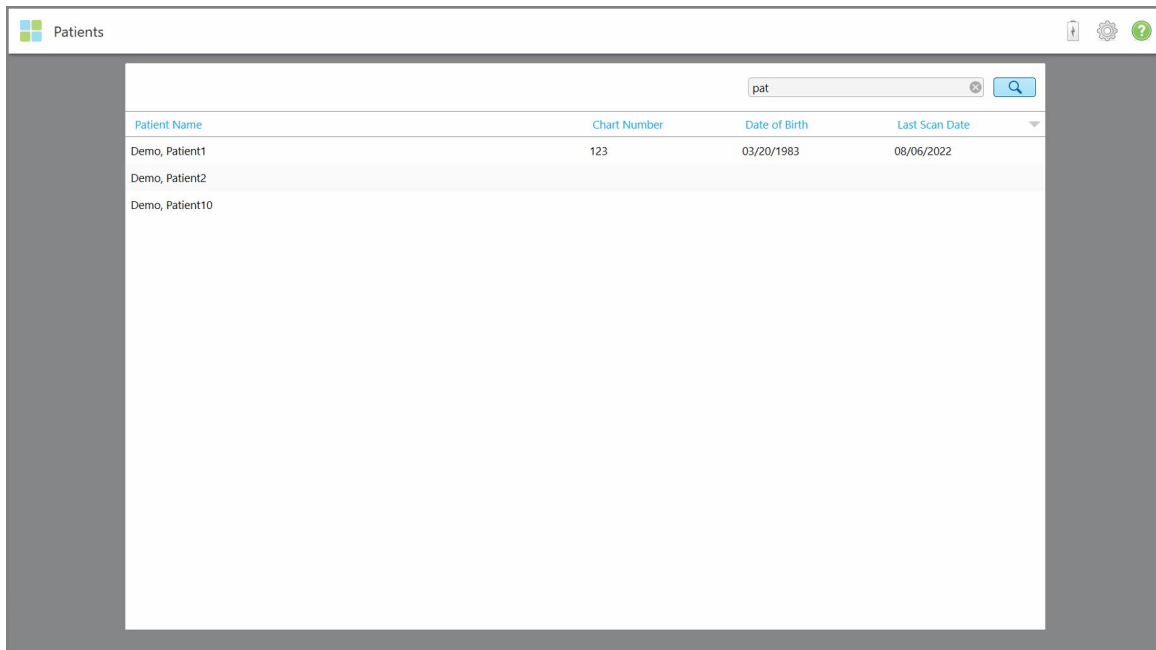
**Figure 139: Patients matching the search criteria are displayed**

6.2 Viewing the patient details

You can view the patient's details, including all the patient's previous scans, in the patient's profile page.

To view the patient details:

1. Tap the **Patients** button on the home screen.

The *Patients* page is displayed, showing a list of patients, their chart number, and the date of their last scan.

2. Select the required patient in the list.

The selected patient's profile page is displayed:

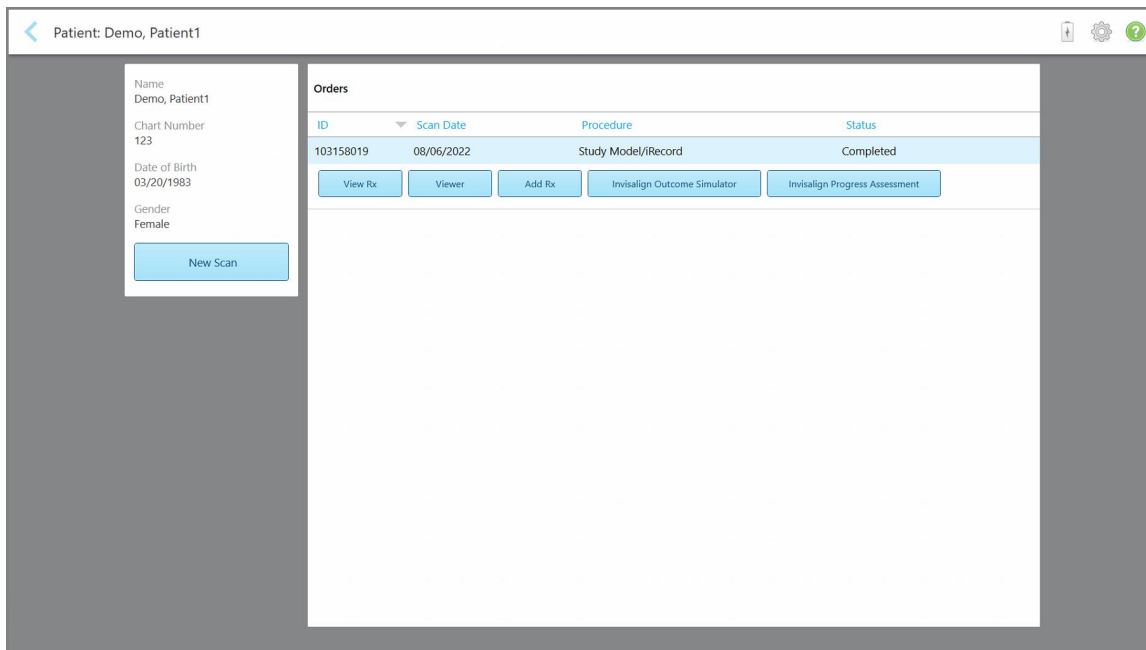

Figure 140: Patient's profile page

From the patient's profile page, you can:

- Create a new scan for the specific patient, described in [Creating a new scan for a specific patient](#)
- View the Rx details and edit the patient's details, described in [Viewing the Rx](#)
- View the patient's previous scans in the Viewer, described in [Viewing previous scans in the Viewer](#)
- Compare 2 previous scans using iTero TimeLapse technology, described in [Comparing previous scans using iTero TimeLapse technology](#)
- View any Invisalign-related processes

6.3 Creating a new scan for a specific patient

If required, you can create a new scan for a specific patient. The Rx opens with the patient's details already filled in.

To create a new scan for a specific patient:

1. In the patient's profile page, tap **New Scan**.

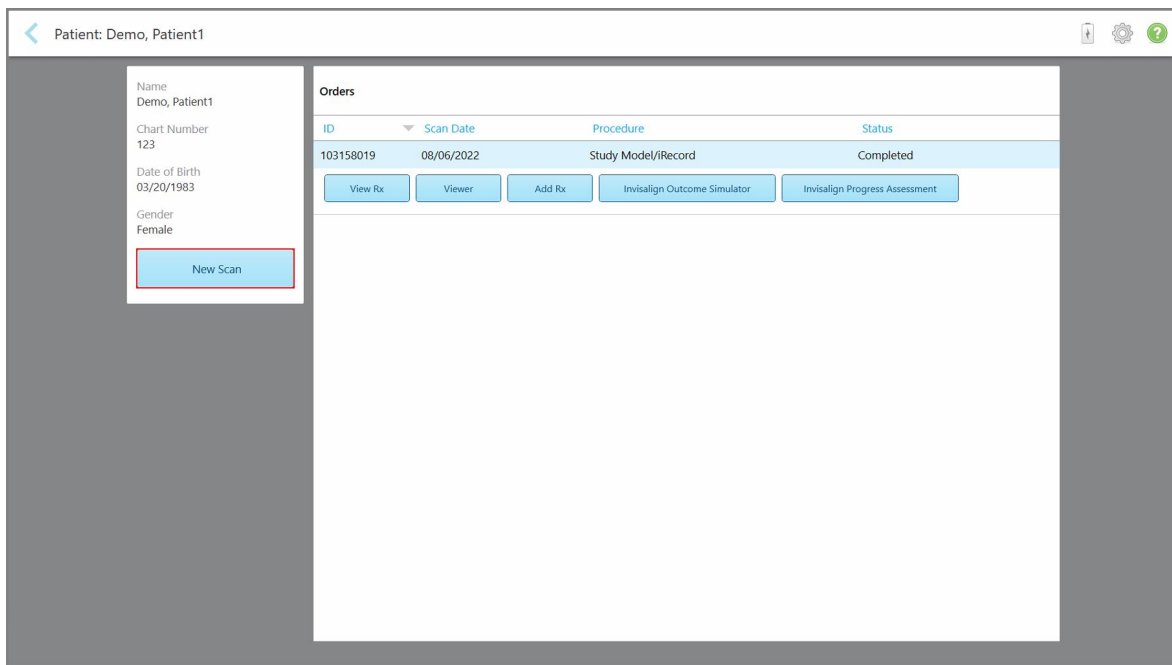

Figure 141: Patient's profile page – New Scan option

The *New Scan* window is displayed, with the patient's details already filled in.

The screenshot shows the 'New Scan' window with the following details filled in:

- Doctor:** Dr. Demo, Demo
- License:** 12345
- Patient:**
 - First Name: Patient1
 - Last Name: Demo
 - Date of Birth: 20/03/1983
 - Chart Number: 123
 - Gender: Male Female
- Order:**
 - Procedure * (dropdown menu)
 - Due Date: (calendar icon)
 - Type (dropdown menu)
 - Send to (dropdown menu)
- Notes:** Add Note (text input field)

Figure 142: New Scan window with patient's details already filled in

2. Fill in the rest of the Rx details according to the new requirements.

6.4 Viewing the Rx

If required, you can view the Rx of a previous order.

To view the Rx of a previous order:

1. In the patient's profile page, select the order for which to view the Rx and then tap **View Rx**.

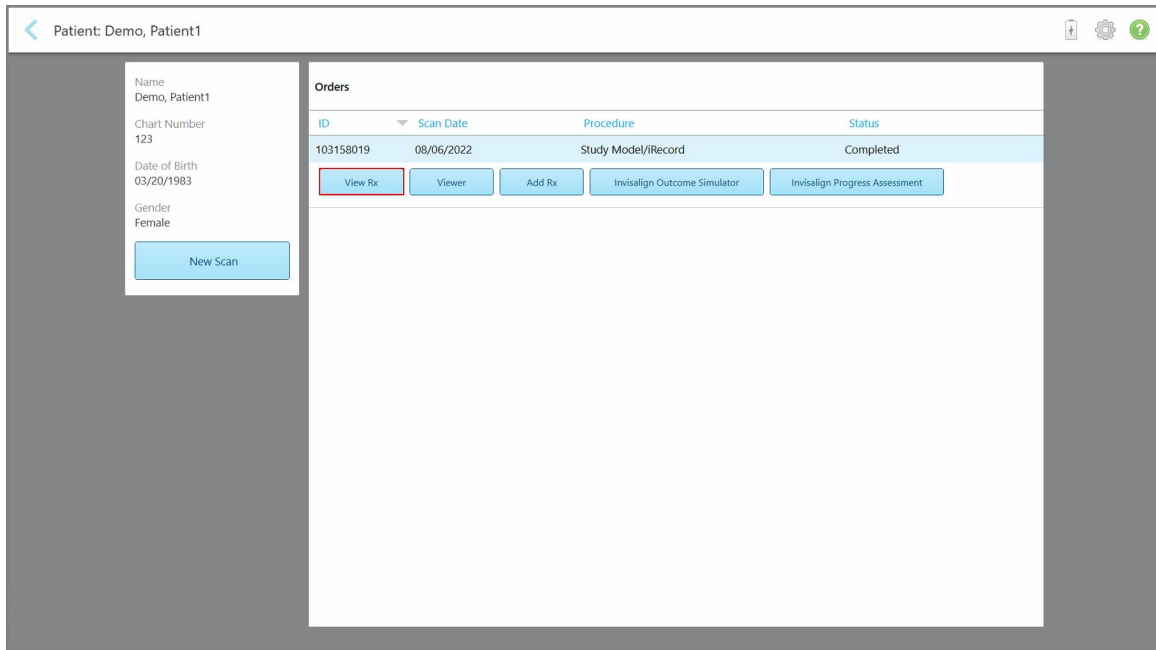



Figure 143: Patient's profile page – View Rx option

The *Rx Details* window is displayed.

The screenshot shows the 'Rx Details' window with the following content:

- Header: Rx Details (with back arrow, lock, settings, and help icons)
- Notice: This Form is Read-only.
- Doctor: Dr. Demo, Demo (License: 12345)
- Patient: First Name: Patient1, Last Name: Demo, Date of Birth: 20/03/1983, Chart Number: 123, Gender: Male Female
- Order: All Study Model/Record scans are available for Invisalign. Procedure: Study Model/Record, Ortho Model/Cast, Due Date, Send to
- Scan Options: Multi-Bite
- Notes

Figure 144: Rx Details window

2. Tap  to return to the patient's profile page.

6.5 Viewing previous scans in the Viewer

If required, you can display previous scans in the Viewer.

To view a previous scan in the Viewer:

1. In the patient's profile page, tap the scan you want to display in the Viewer and then tap **Viewer**.

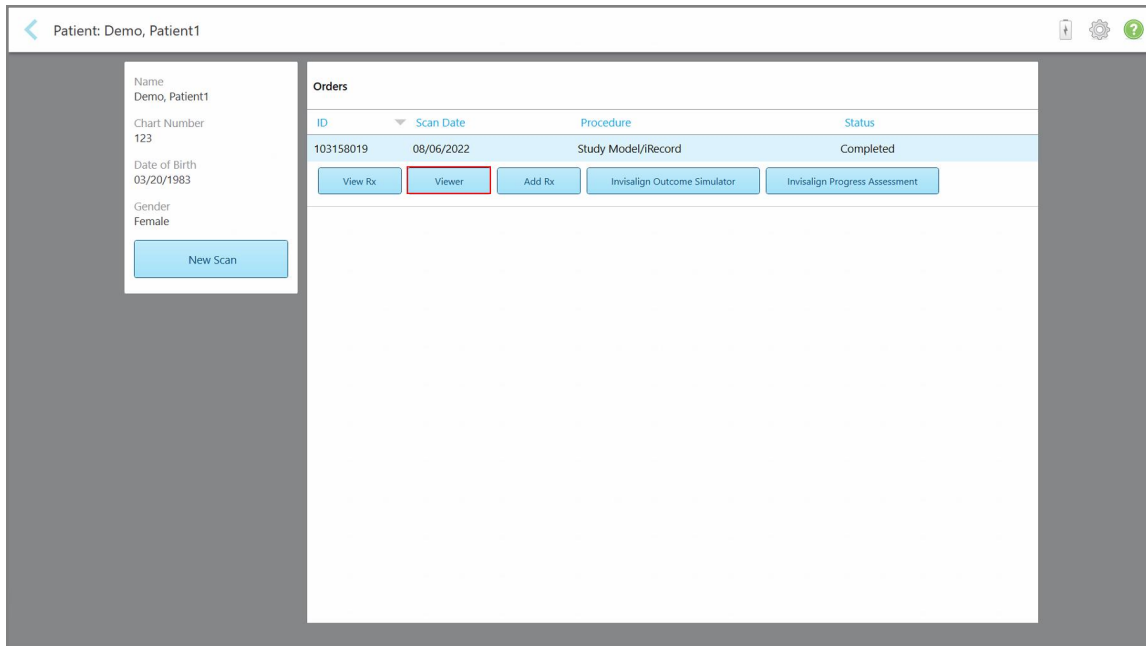

Figure 145: Patient's profile page – Viewer option

The scan is displayed in the Viewer.

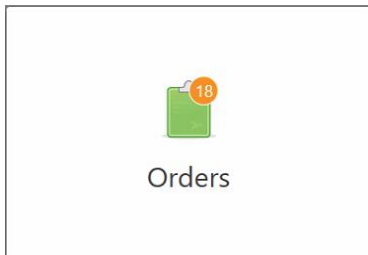

Figure 146: Scan displayed in the Viewer

For more information on working with the Viewer, see [Working with the Viewer](#).

7 Working with orders

Tap the **Orders** button to display a list of all your orders. The button may contain a badge that indicates the number of orders that have not been submitted yet.



If an order has been returned from the lab, the button is displayed in red, with an alarm icon badge, as described in [Working with orders](#).

The *Orders* page is made up of two panes listing the orders that are still in progress and the ones that have already been submitted.

You can view the following details for each order: the order ID, patient's name, chart number, the scan date, procedure, and the status of the order.

The order could have one of the following statuses, depending on the procedure:

- **Rx Created:** The Rx has been filled in, but the patient has not been scanned yet.
- **Scanning:** The scan process is in progress.
- **Sending:** The scan is in the process of being sent.
- **Sent:** The scan has been sent.
- **Failed to Send:** The scan was not sent.
- **iTero Modeling:** The scan has been sent to iTero Modeling.
- **Ortho Modeling:** The scan has been sent for modeling.
- **Lab Review:** The scan has been sent to the lab for review.
- **Returned:** The scan was rejected by the lab and has been sent back for rescanning or other adjustments, as described in [Working with orders](#).
- **Align Production:** The scan is undergoing an internal process.
- **Exporting to Doctor Site:** The scan is on the way to the IDS portal.
- **Completed:** The flow has been completed.

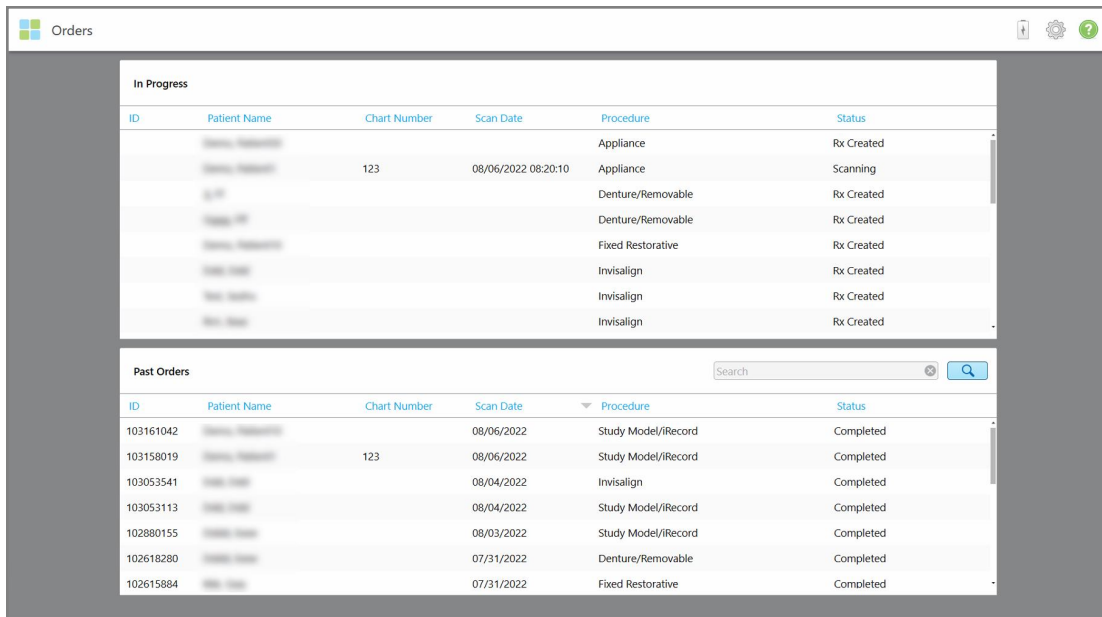

Figure 147: Orders page

To view or review orders:

1. Tap the **Orders** button on the home screen.

The *Orders* page is displayed, showing two panes – **In Progress** orders and **Past Orders**.

- **In Progress:** Scans that have not yet been submitted.
- **Past Orders:** Scans that have already been submitted.

2. Tap on an order in the **In Progress** pane to view the following options:

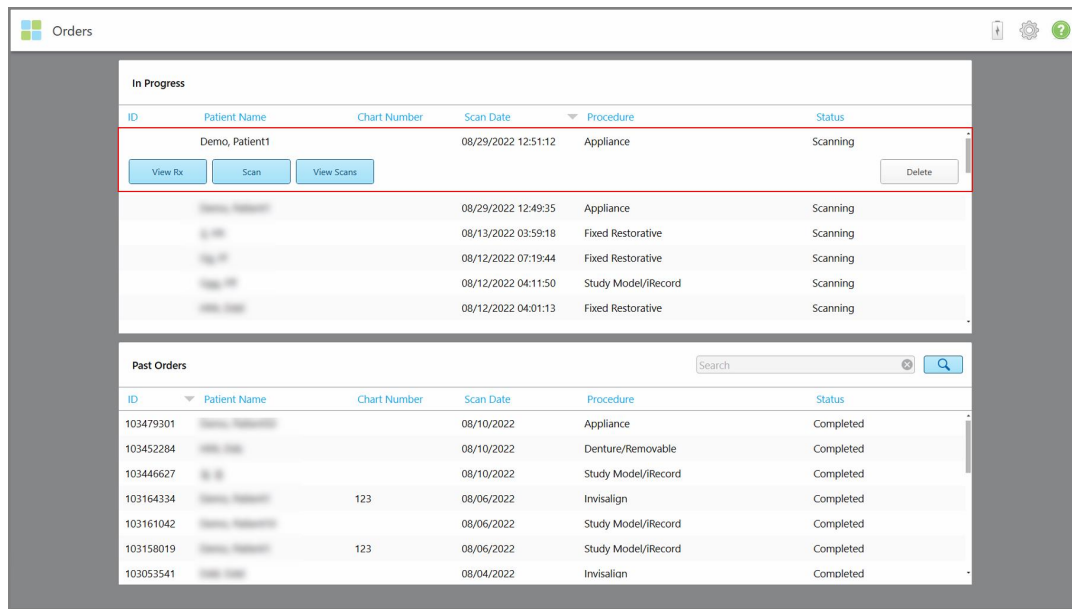

Figure 148: In Progress pane – options

- **View Rx:** Opens the *Rx Details* window, enabling you to view the prescription for this order.
 - **Scan:** Opens the *Scan* window, enabling you to create a new scan or continue scanning the patient.
 - **View Scans:** Opens the *View* window, enabling you to review the current scan.
3. Tap an order in the **Past Orders** pane to view the following options, depending on the procedure:

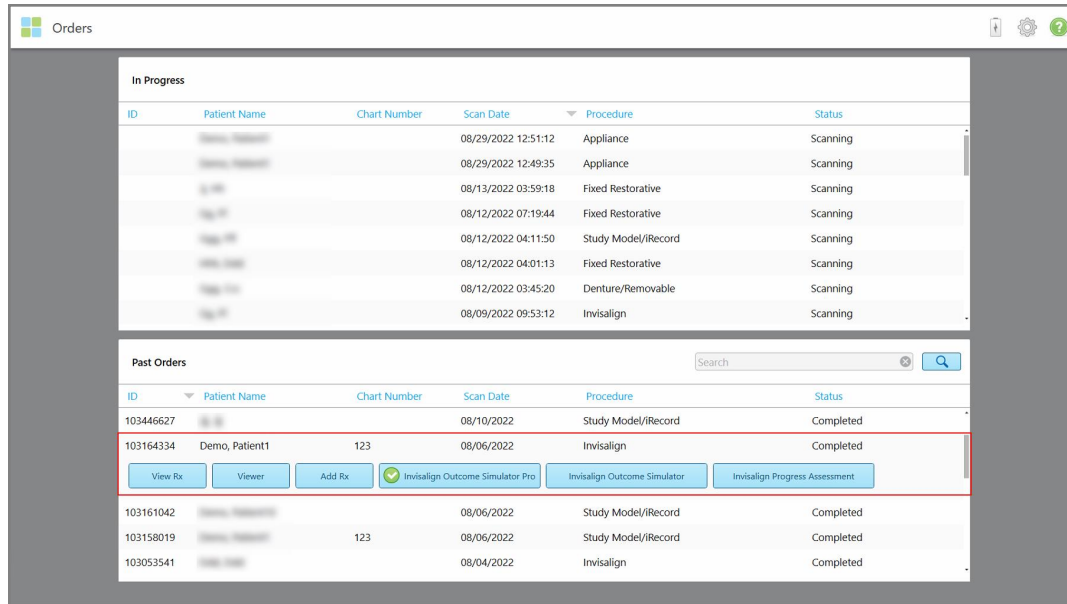

Figure 149: Past Orders pane – options

- **View Rx:** Opens the *Rx Details* window, enabling you to view the prescription for this order.
- **Viewer:** Opens the *Viewer* window, enabling you to view and manipulate the model. For more information on working with the Viewer, see [Working with the Viewer](#).
- **Add Rx:** Opens the *New Scan* window and enables you to add a prescription for this order.
Note: This is applicable for Orthodontic orders only, and available for up to 21 days after the scan.
- Invisalign users can also select the following Invisalign features:
 - [Invisalign Outcome Simulator Pro](#)
 - [Invisalign Outcome Simulator](#)
 - [Invisalign Progress Assessment](#)
 - [Invisalign Go system](#)
 - [Invisalign Go system](#)

7.1 Working with returned orders

Labs can return orders within 30 days if the scan is incomplete and needs to be rescanned, for example, if there are missing scans, bite issues, or if the margin line is not clear. If the lab returns an order, the **Orders** button is highlighted in red with an alarm icon badge.

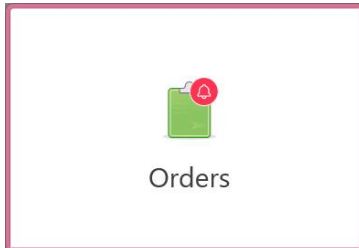

Figure 150: Orders button notifying a returned order

The returned order is displayed at the top of the **In Progress** pane, with the status **Returned**, in red.

 The screenshot shows the "Orders" application window. At the top left, there is a logo and the word "Orders". At the top right, there are icons for a list, settings, and help. The main content area is divided into two sections: "In Progress" and "Past Orders". The "In Progress" section contains a table with columns for ID, Patient Name, Chart Number, Scan Date, Procedure, and Status. The first row is highlighted with a red border and has the status "Returned" in red text. The "Past Orders" section contains a search bar and a table with the same columns as the "In Progress" section, showing several completed orders.

In Progress						
ID	Patient Name	Chart Number	Scan Date	Procedure	Status	
103181639	Demo, Patient1	123	08/07/2022 00:52:32	Appliance	Returned	
		12345		Invisalign	Rx Created	
				Invisalign	Rx Created	
				Invisalign	Rx Created	
				Invisalign	Rx Created	
				Study Model/iRecord	Rx Created	
				Invisalign	Rx Created	
				Study Model/iRecord	Rx Created	

Past Orders						
ID	Patient Name	Chart Number	Scan Date	Procedure	Status	
102880155			08/03/2022	Study Model/iRecord	Completed	
103053113			08/04/2022	Study Model/iRecord	Completed	
103158019		123	08/06/2022	Study Model/iRecord	Completed	
103161042			08/06/2022	Study Model/iRecord	Completed	
102036203			07/24/2022	Appliance	Completed	
102180850			07/26/2022	Invisalign	Completed	
99976922			06/28/2022	Invisalign	Completed	

Figure 151: Returned order in the In Progress pane

To fix a returned order:

1. Open the returned order and fix the scan according to the lab's instructions in the **Notes** area of the Rx.
2. Return the order to the lab.

8 Viewing messages

The *Messages* page displays notifications, updates, and other system messages from Align Technology, for example, product updates, upcoming educational sessions, or internet connectivity issues.

If relevant, you can view the number of new or unread messages on the badge on the **Messages** button.

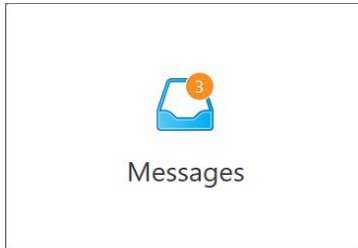

To view the messages:

1. Tap the **Messages** button on the home screen.

A list of notifications, updates, and other messages from Align Technology is displayed.

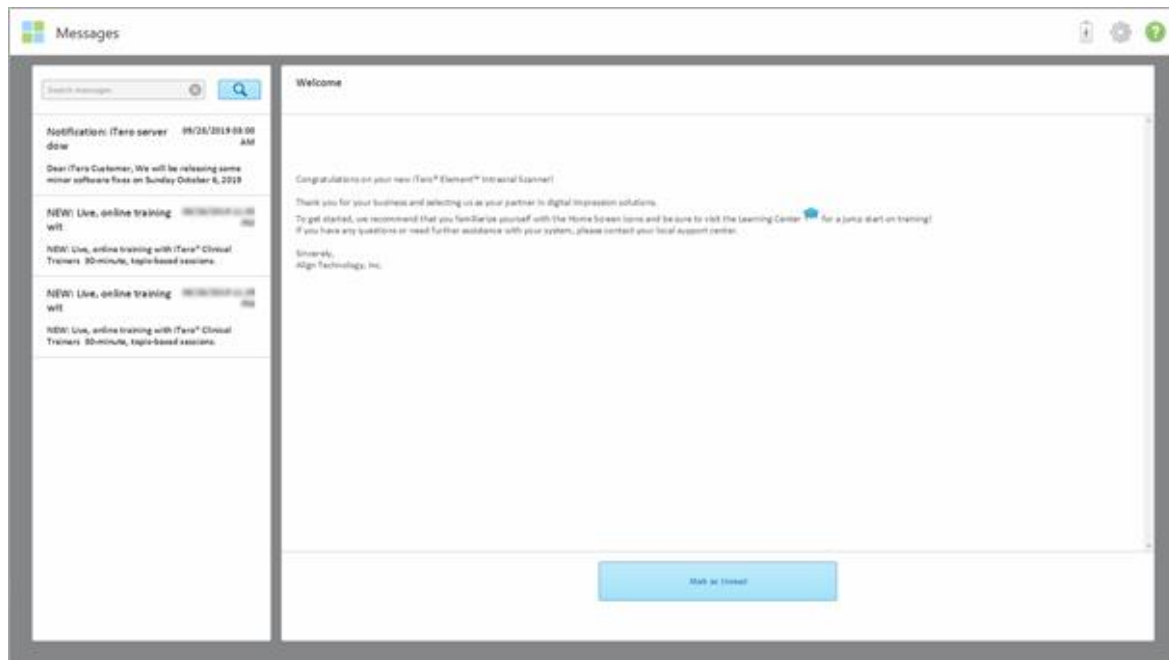

Figure 152: Messages page

2. In the left pane, quickly search for a specific message by subject title or scroll down the pane to find a specific message.
3. To mark any message as unread, tap **Mark as Unread**.

9 Working with MyiTero

MyiTero is a web-based portal, with the same look-and-feel as the iTero software. It enables users to carry out administrative tasks such as filling in a new Rx on any supported device, for example, a PC or a tablet, without using valuable scanner time. In addition, it enables viewing 3D models after they have been created by the scanner, and tracking orders.

10 iTero scanner features and tools

This section describes the following iTero scanner features and tools:

- [Comparing previous scans using iTero TimeLapse technology](#)
- [Invisalign Outcome Simulator Pro](#)
- [Invisalign Outcome Simulator](#)
- [Invisalign Progress Assessment](#)
- [Invisalign Go system](#)
- [Editing tools](#)
 - [Deleting a segment](#)
 - [Deleting a selection](#)
 - [Filling in missing anatomy](#)
 - [Disabling auto-cleanup](#)
- Scan tools:
 - [Working with the Eraser tool](#)
 - [Working with the Occlusal Clearance tool](#)
 - [Working with the Edge Trimming tool](#)
 - [Working with the Die Separation tool](#)
 - [Working with the Margin Line tool](#)
 - [Working with the Snapshot tool](#)

10.1 Comparing previous scans using iTero TimeLapse technology

Patients who are scanned regularly can have their scans analyzed using iTero TimeLapse technology.

iTero TimeLapse technology compares 2 of the patient's previously captured 3D scans to allow visualization of the changes in the patient's teeth, tooth structure, and oral soft tissues over the period between the scans. For example, iTero TimeLapse technology can display tooth wear, gingival recession, and tooth movement over the relevant period.

Note: iTero TimeLapse technology is available for Orthodontic procedures only.

To use iTero TimeLapse technology:

1. In the *Patients* page, select the patient for whom to create an iTero TimeLapse visualization.

- In the patient's profile page, select two scans to compare. You can select the scans by selecting the check boxes next to the relevant orders, or by selecting the check boxes in the **Timeline** area at the bottom of the page.

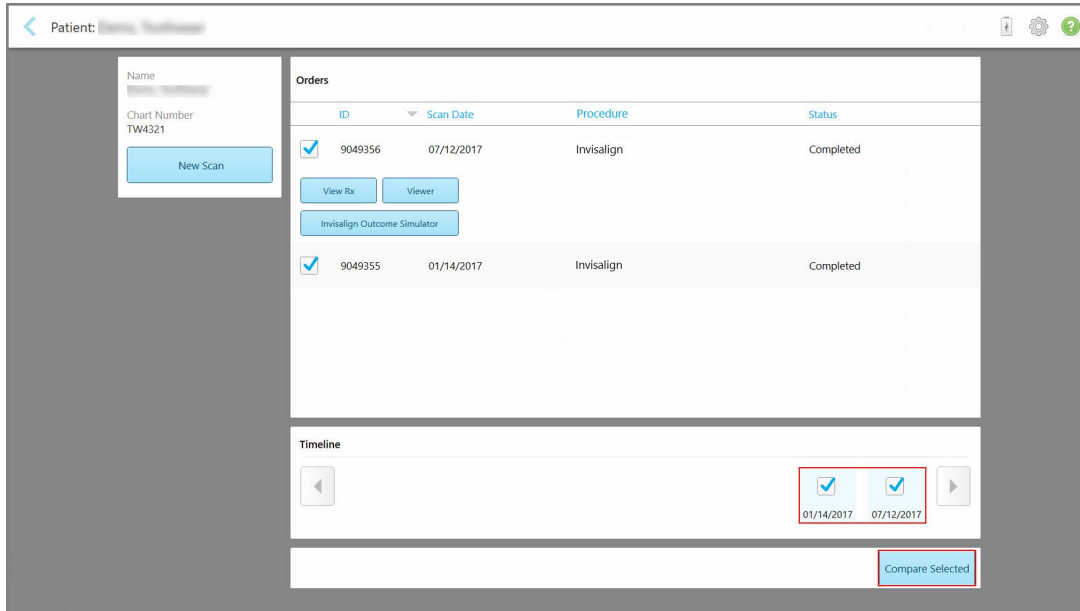

Figure 153: iTero TimeLapse – selecting the scans to compare

- Tap the **Compare Selected** button to compare and analyze the scans.

The *iTero TimeLapse* window is displayed, highlighting the areas with changes between the scans. The darker the color, the bigger the change between the scans, as displayed in the legend.



Figure 154: iTero TimeLapse window showing the highlighted changes between the scans

Note: Changes are highlighted only when the scans are displayed in monochrome mode.

If required, tap  to move the scan to the default occlusal view – lower arch with anterior teeth at the bottom and upper arch with anterior teeth at the top and both arches in a frontal view like the iRecord default view.

4. Drag the loupe onto the model to view areas of interest and potential treatment areas in the animation window. An animation is displayed, comparing the state of the teeth in the current area of interest on the selected scan dates.



Figure 155: Area of interest from the first scan displayed in the animation window



Figure 156: Area of interest from the second scan displayed in the animation window

You can zoom in to the image in the animation window or tap the pause button  to pause the animation. If required, you can change the scale of the changes displayed.

- a. On the legend, tap **Scale**.

The legend is expanded to display a list of ranges:

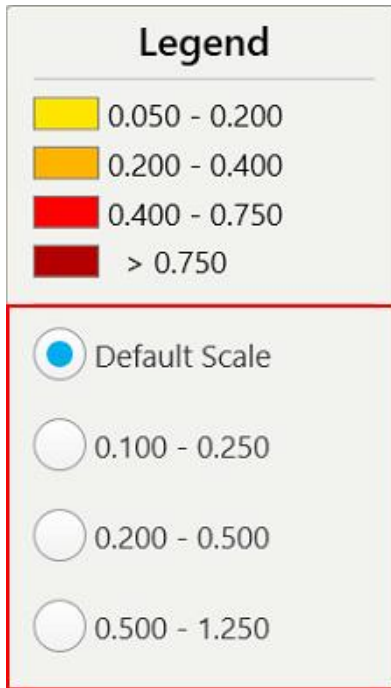



Figure 157: iTerio TimeLapse scale options

- b. Select the required scale.

The changes are displayed according to the new scale.

5. If required, tap the Snapshot tool  to capture a screenshot of the images. For more information, refer to [Working with the Snapshot tool](#).

6. Tap  to exit the *iTerio TimeLapse* window and then tap **Yes** to confirm exiting. The patient's profile page is displayed.

10.2 Invisalign Outcome Simulator Pro

Invisalign Outcome Simulator Pro is an advanced patient communication software tool that enables you to show patients the simulated outcome of their Invisalign treatment on an image of their own face. This tool provides additional information for the patient in their decision to begin Invisalign treatment.

Notes:

- Invisalign Outcome Simulator Pro is supported on iTero Element Plus series intraoral scanners only.
- The Invisalign Outcome Simulator Pro simulation is available only for **Study Model/iRecord** procedures and **Invisalign Aligners** procedure types, and is automatically triggered when sending the scan.
- Invisalign Outcome Simulator Pro requires pairing your Invisalign Doctor Site account with your iTero account. For more information, contact iTero Customer Support.



Once the simulation is complete, you can tap  in the Viewer or the **Invisalign Outcome Simulator Pro** button in the *Orders* page, as described in [Working with orders](#).

For more information on using Invisalign Outcome Simulator Pro, refer to the Invisalign Outcome Simulator Pro documentation.

10.3 Invisalign Outcome Simulator

Invisalign Outcome Simulator is a software tool that enables you to show the patients the simulated outcome of their Invisalign treatment.

You can make real-time adjustments to the simulated outcome while showing the patient. This tool provides additional information for the patient in their decision to accept treatment.

To open the Invisalign Outcome Simulator tool, after sending the scan, tap **Invisalign Outcome Simulator** in the *Orders* page, as described in [Working with orders](#), or in the patient's profile page, as described in [Viewing the patient details](#).

For more information on the Invisalign Outcome Simulator tool, refer to the *Invisalign Outcome Simulator User Guide* <https://guides.itero.com>.

10.4 Invisalign Progress Assessment

The Progress Assessment tool includes a report that is a color-coded tooth movement table to assist the user in making treatment decisions to track the patient's progress in their ClinCheck treatment plan.

To open the Invisalign Progress Assessment tool, after sending the scan, tap **Invisalign Progress Assessment** in the *Orders* page, as described in [Working with orders](#).

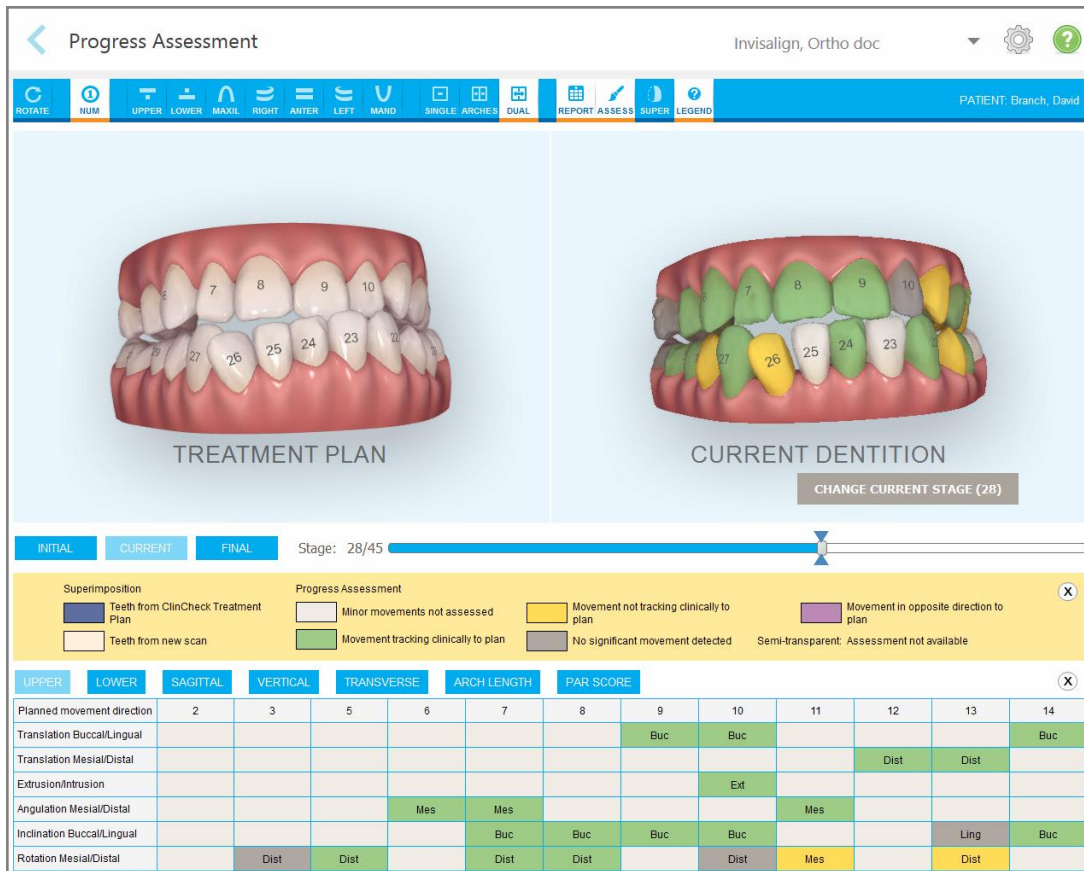

Figure 158: Progress Assessment window

For more information regarding the Invisalign Progress Assessment tool, refer to the **Progress Assessment** section in the *Invisalign Outcome Simulator User Guide* <https://guides.itero.com>.

10.5 Invisalign Go system

Invisalign Go is a low-stage aligner product that helps you assess and treat patients in just a few taps, with guidance every step of the way.

For more information regarding the Invisalign Go System, refer to the Invisalign documentation.

10.6 Editing tools

After you have scanned the model, you can edit it using the following tools:

- Delete Segment tool, described in [Deleting a segment](#)
- Delete Selection tool, described in [Deleting a selection](#)
- Fill tool, described in [Filling in missing anatomy](#)
- Disable auto-cleanup tool, described in [Disabling auto-cleanup](#)

The editing tools are accessed by pressing on the screen.

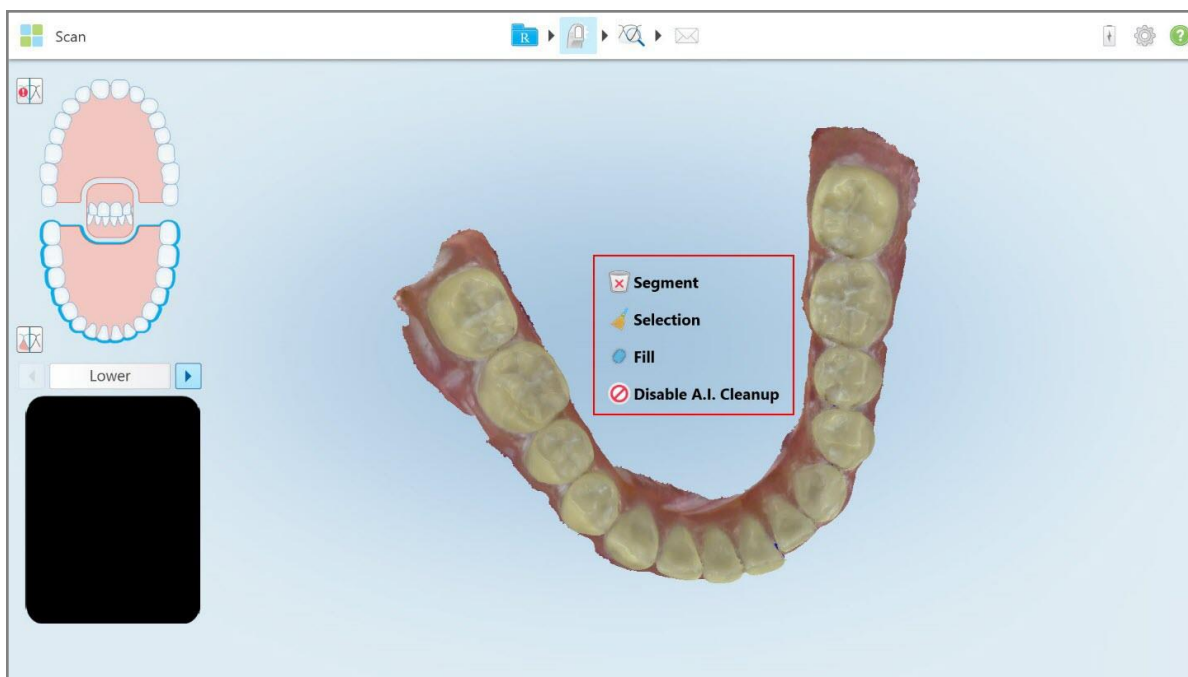

Figure 159: Editing tools

10.6.1 Deleting a segment

The Delete Segment tool enables you to delete the entire scanned segment.

To delete the segment:

1. Press the screen to display the editing tools.

2. Tap the **Delete Segment** tool .

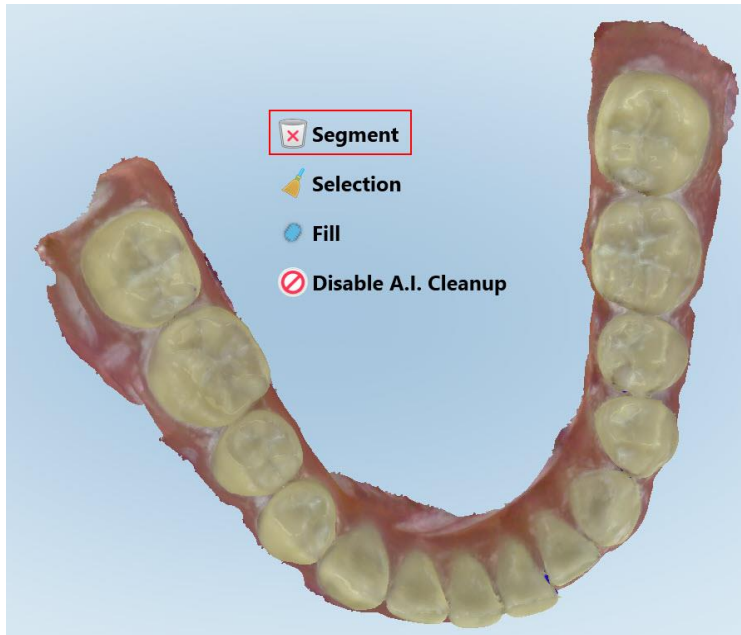



Figure 160: Delete Segment tool

A confirmation message is displayed.

3. Tap **OK** to confirm the deletion.
The entire scanned segment is deleted.

10.6.2 Deleting a selection

The Delete Selection tool  enables you to delete a section of the scan so that it can be rescanned.

To delete a selection:

1. Press the screen to display the editing tools.
2. Tap the **Delete Selection** tool .

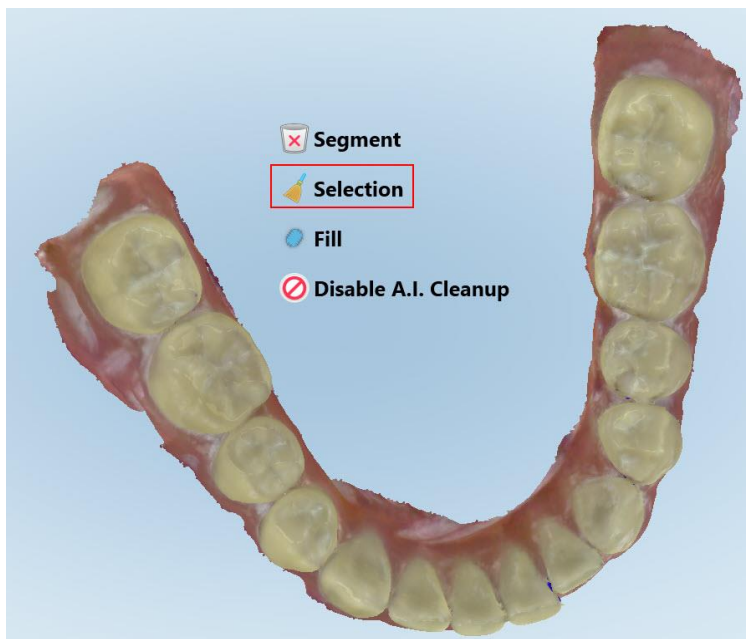

Figure 161: Delete Selection tool

The Delete Selection tool expands, and the model is displayed in monochrome.

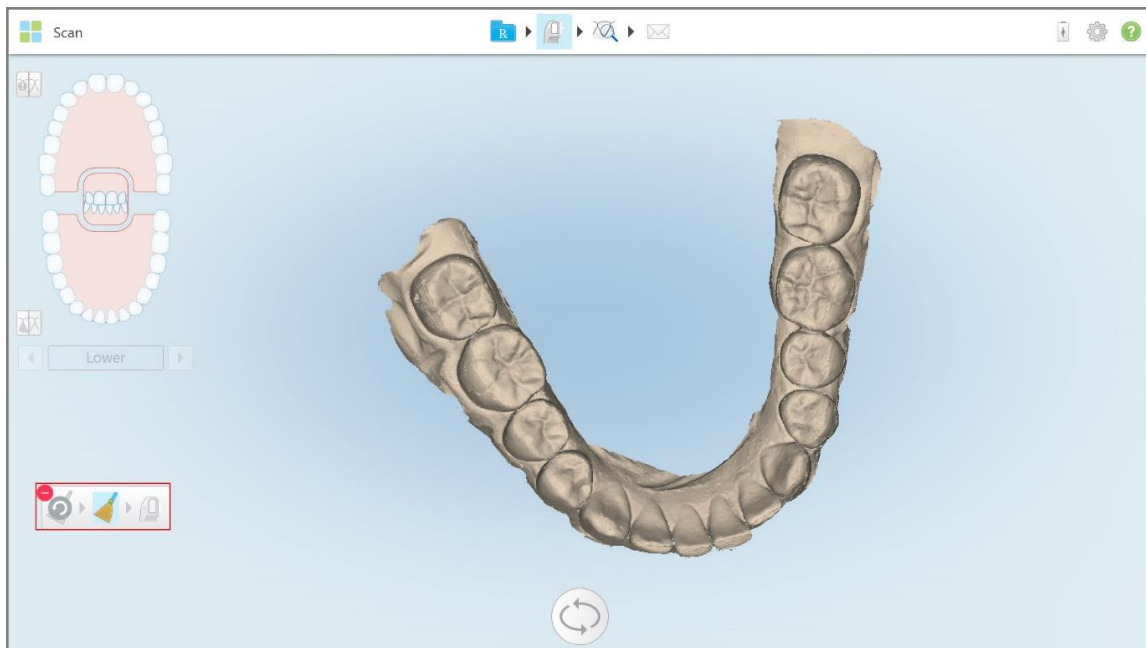

Figure 162: Expanded Delete Selection tool

3. Touch the area of the anatomy you want to delete.

The selection is removed.

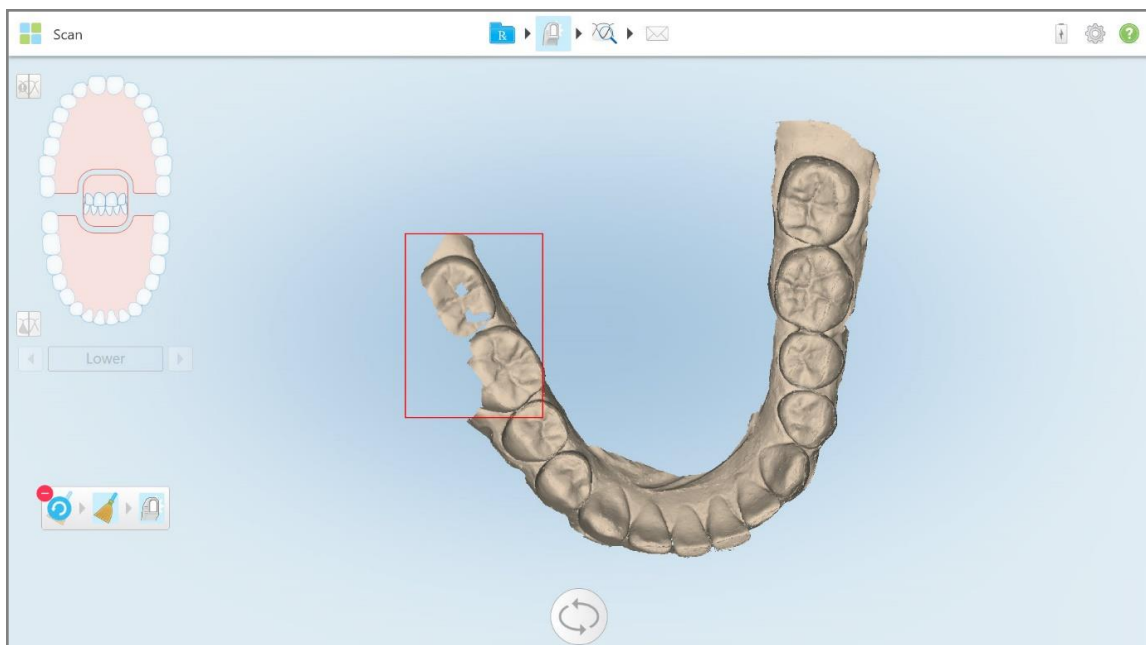





Figure 163: Selected area of the anatomy is deleted

4. If required, tap  to undo the changes.
5. Tap  to rescan the deleted anatomy.

10.6.3 Filling in missing anatomy

Occasionally there are areas with missing anatomy that are not filled even after trying to scan the area numerous times. These areas may be caused by the interference of anatomy (lips, cheeks, and tongue) or moisture in the scanning segment.

The Fill tool  highlights these areas and then scans only the highlighted areas, in order to prevent over-scanning.

To use the Fill tool:

1. Press the screen to display the editing tools.
2. Tap the **Fill** tool .

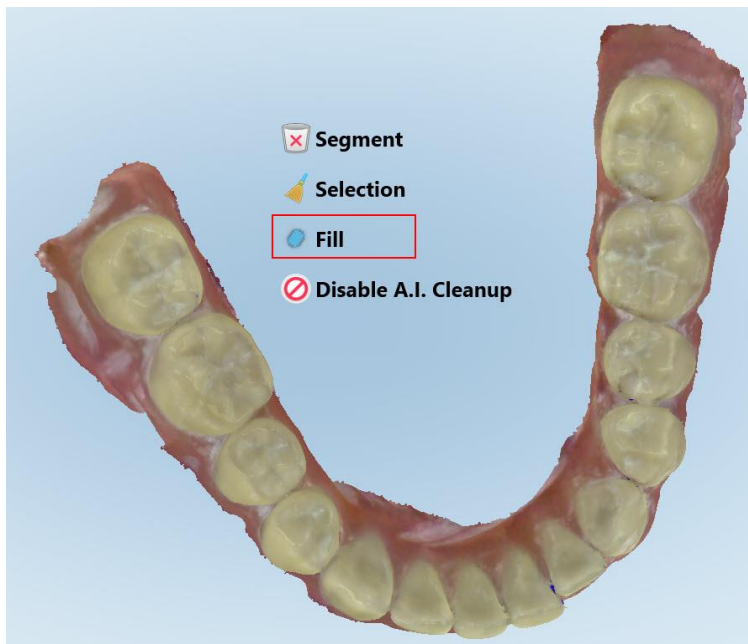

Figure 164: Fill tool

Areas that require scanning are highlighted in red.

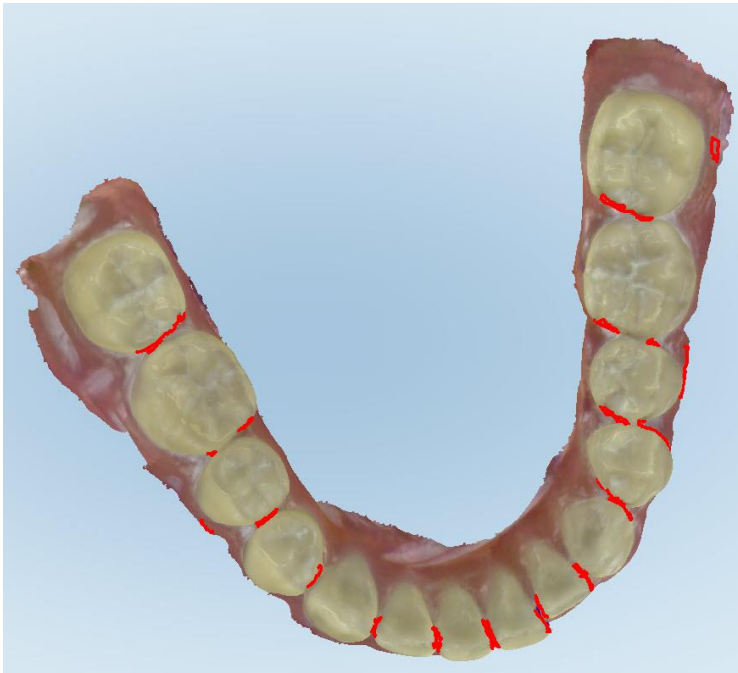

Figure 165: Areas that require scanning are highlighted in red – Fill tool

3. Rescan the patient.

In order to prevent over-scanning, only the highlighted areas are scanned, and the voids are filled.

10.6.4 Disabling auto-cleanup

By default, excess tissue is removed from around the edges of the 3D model during scanning. If required, you can turn off this functionality for the current scan.

Notes:

- This tool is not supported for edentulous gums.
- Disabling auto-cleanup is relevant for the current scan only. Excess material will be removed by default in the next scan.

To disable auto-cleanup:

1. Press the screen to display the editing tools.

2. Tap the **Disable A.I. Cleanup** tool.

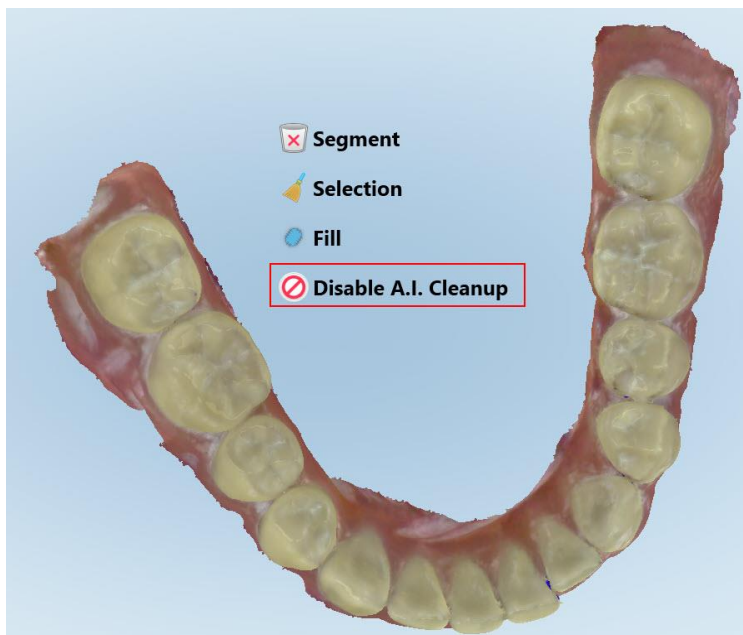

Figure 166: Auto-cleanup tool

The scan is displayed with the excess material showing.



Figure 167: Scan displayed with excess material showing

3. To return the excess tissue, press the screen to display the editing options and then tap **Enable A.I. Cleanup**.

10.7 Working with the Eraser tool



The Eraser tool enables you to erase a selected area of the scanned model and then rescan only the erased area.

For example:

- You can remove moisture and artifacts, such as blood or saliva, that are covering the margin.
- If the prepped tooth shows areas of red on the Occlusal Clearance legend, you can reduce the prepped tooth, erase the area on the model, and then rescan it, as described below.

To erase part of the scan:

1. In the *View* window, ensure you are on the relevant section to be erased, and then tap the Eraser tool

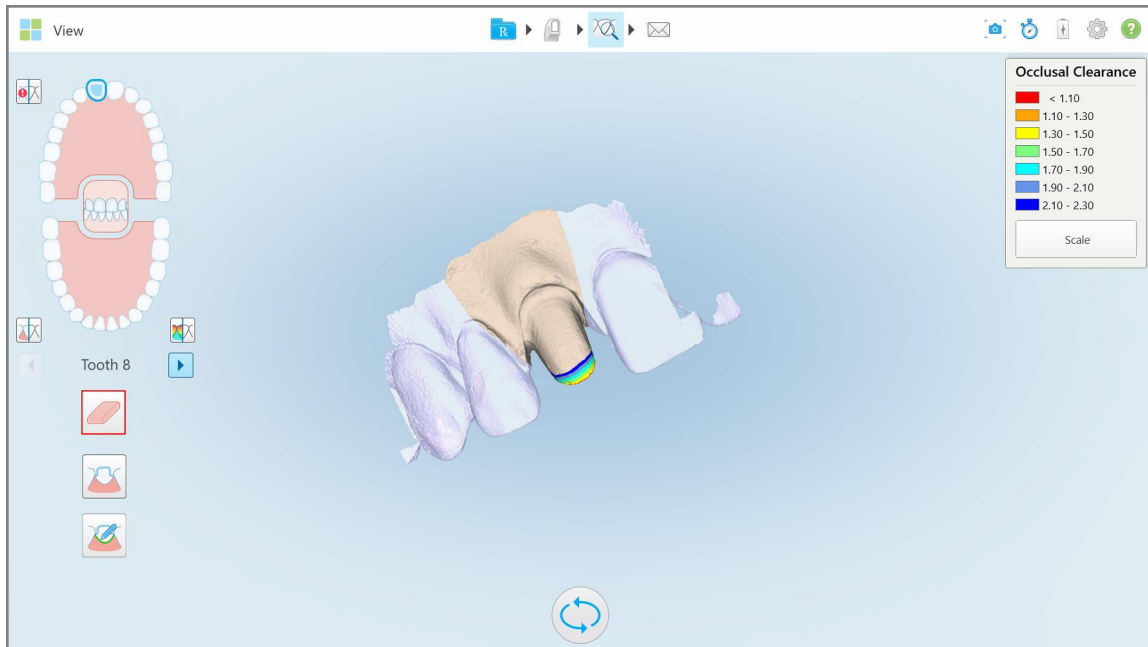

Figure 168: Eraser tool

The Eraser tool expands to show the following options:



Figure 169: Eraser tool options

2. With your finger, mark the area to be modified.

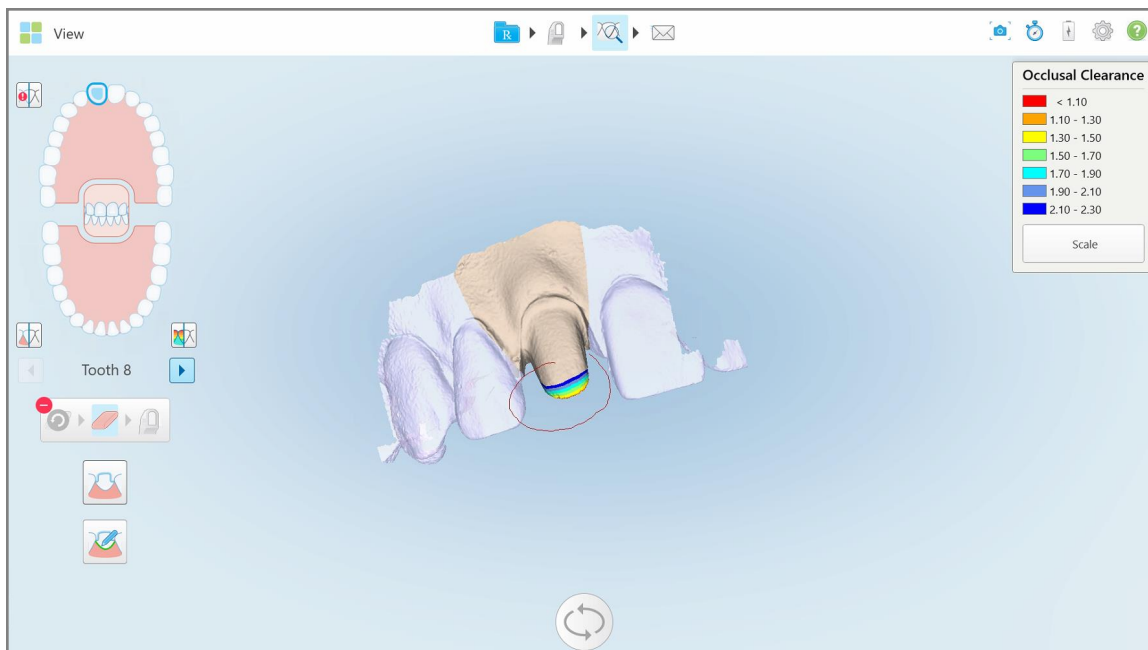

Figure 170: Mark the area to be modified

As soon as you lift your finger, the selected area is removed and the scan tool  is enabled.

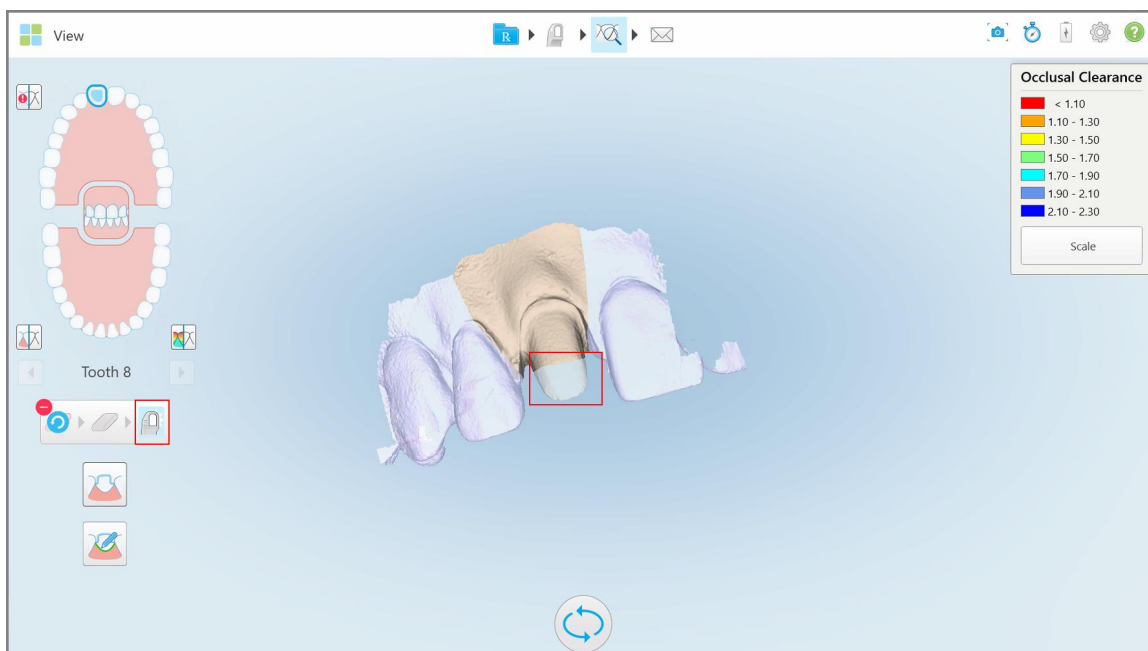



Figure 171: Selected area removed, and scan tool enabled

3. If required, tap  to undo the deletion.
4. After adjusting the clearance on the patient's tooth, tap  to return to Scan mode and rescan the deleted area, which is marked in red.

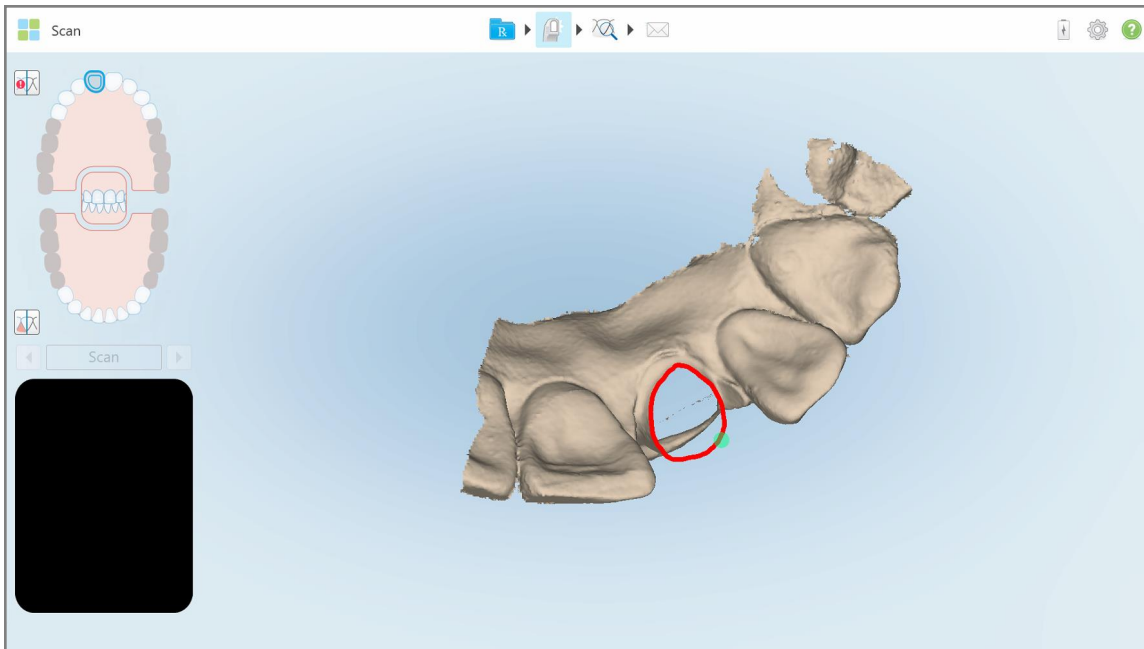



Figure 172: Deleted area marked in red

5. Tap the Occlusal Clearance tool  to confirm that the prepped tooth was sufficiently reduced.

10.8 Working with the Occlusal Clearance tool

The Occlusal Clearance tool  enables you to view the contact and distance between the opposing teeth, for example, to ensure that the prepped tooth has sufficient reduction for the material chosen in the Rx.

The Occlusal Clearance tool can be accessed while in View mode and from the Viewer.

Note: The Occlusal Clearance tool is displayed only after you have scanned the upper and lower jaws, and the bite.

To display the occlusal clearance while in View mode:

1. In the *View* window, tap the Occlusal Clearance tool .

The occlusal clearance between the opposing teeth is displayed.

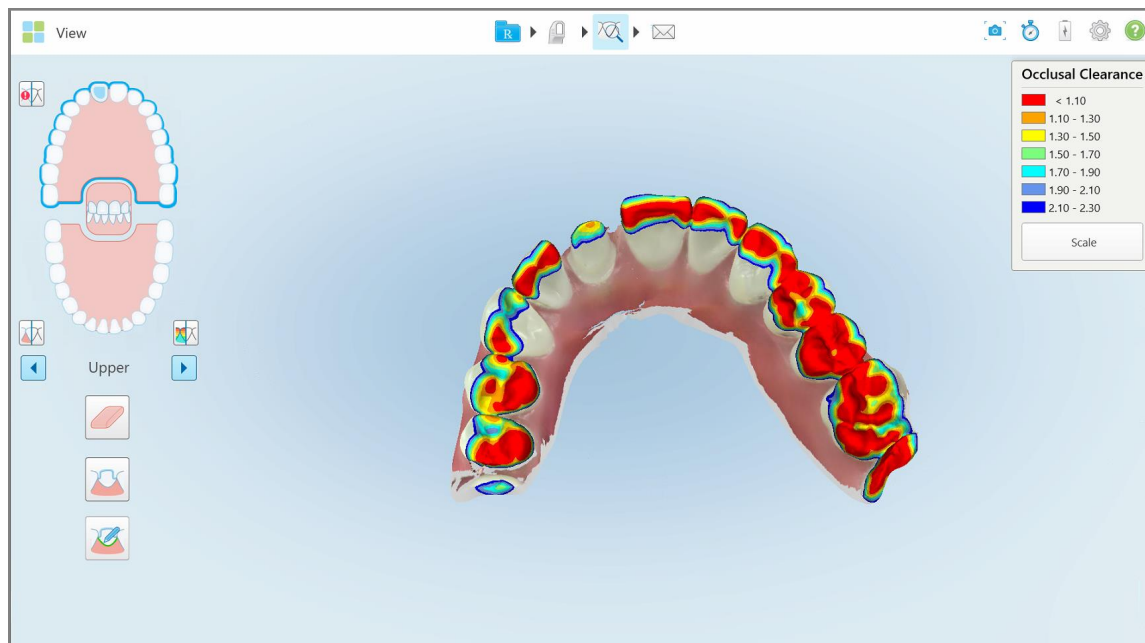

Figure 173: Occlusal clearance between the opposing teeth

2. If necessary, reduce the prepped tooth and rescan the area, as described in [Working with the Eraser tool](#).
3. If required, you can change the occlusal values displayed on the opposing teeth.

- a. On the legend, tap **Scale**.

The legend is expanded to display a list of range options.



Figure 174: Occlusal Clearance range options

- b. Select the required scale.
c. The occlusal clearance is displayed according to the new scale.

4. If required, tap  to take a screenshot of the occlusal clearance. For more information on capturing screenshots and adding annotations, see [Working with the Snapshot tool](#).

To display the occlusal clearance from the Viewer:

1. Open the past order of a specific patient in the *Orders* page, or from a specific patient's profile page, tap **Viewer** to display the Viewer.



2. In the Viewer, tap .
3. Select the arch for which to display the occlusal clearance.

The clearance between the opposing teeth is displayed, as well as a legend displaying the scale.

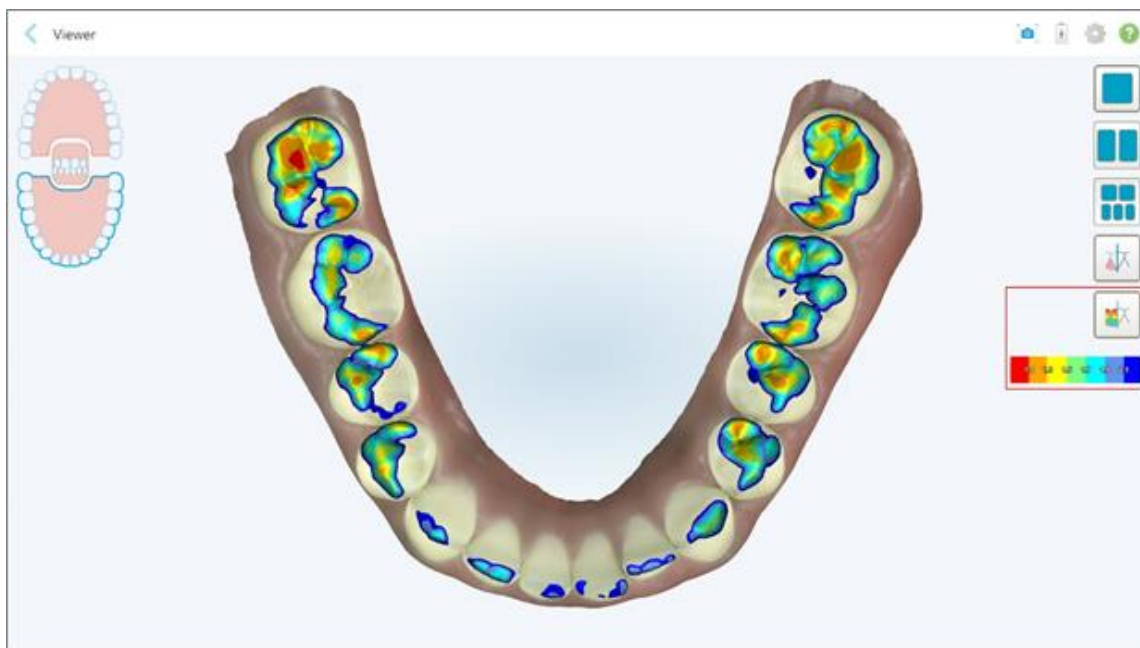





Figure 175: Occlusal Clearance tool and legend displayed in the Viewer

3. If required, tap  to take a screenshot of the occlusal clearance. For more information on capturing screenshots and adding annotations, see [Working with the Snapshot tool](#).

10.9 Working with the Edge Trimming tool

The **Edge Trimming** tool  enables you to trim away excess soft tissue such as cheek or lip artifacts from the scan. This tool is available for Orthodontic procedures only.

To trim the excess material:

1. In the *View* window, tap the Edge Trimming tool .

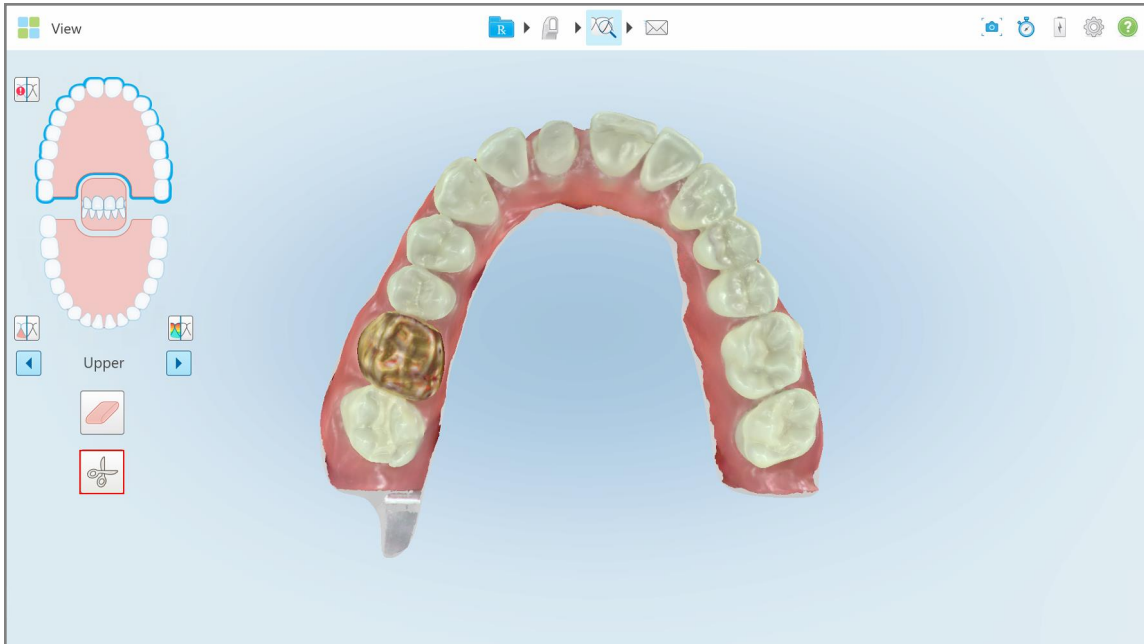

Figure 176: Edge Trimming tool

The Edge Trimming tool expands to show the following options:



Figure 177: Edge Trimming tool options

2. With your finger, mark the area you would like to trim away.

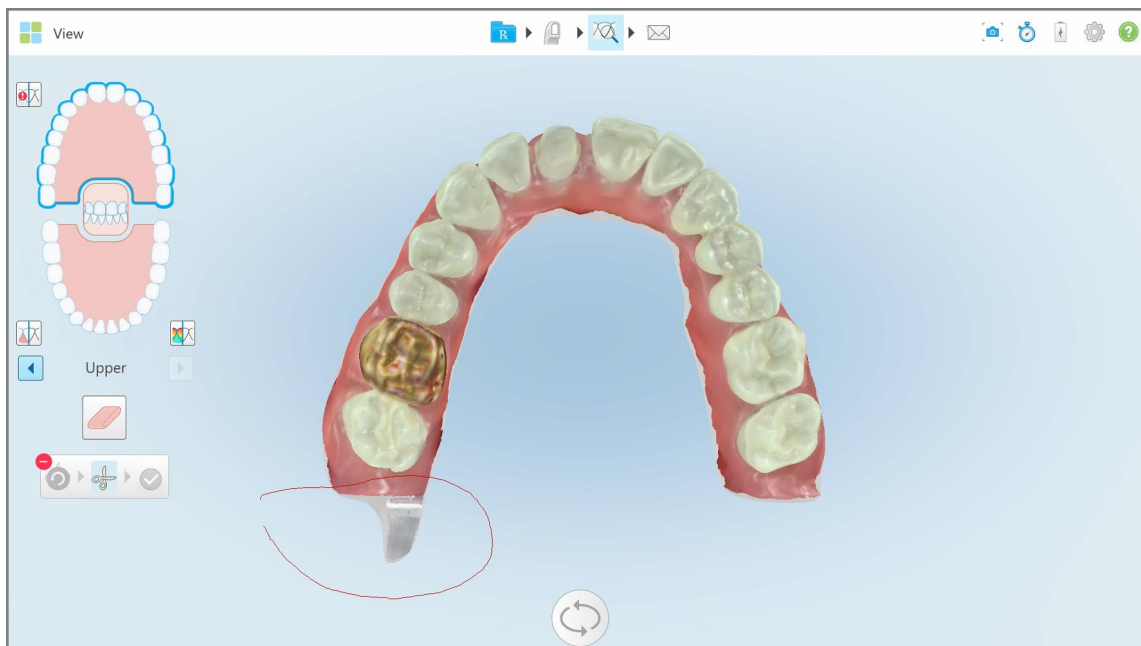

Figure 178: Mark the area to be trimmed away

The area to be trimmed away is highlighted and the confirmation icon is enabled.

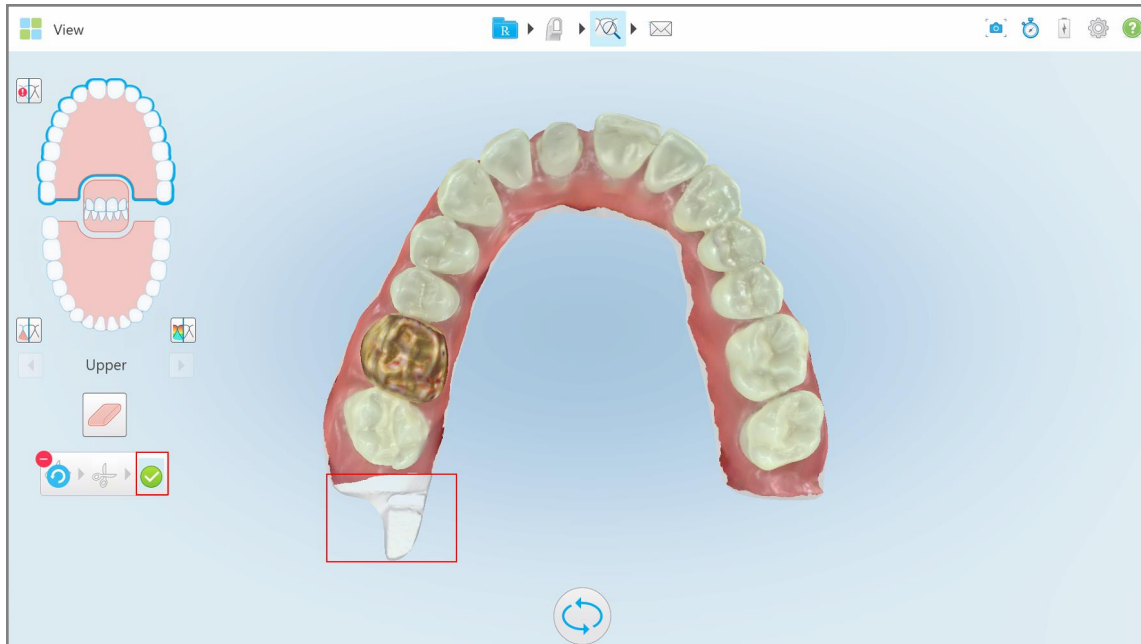



Figure 179: Selected area is highlighted, and the confirmation icon is enabled

3. If required, you can tap  to undo the trimming.
4. Tap  to confirm the trimming.
The selected area is removed.

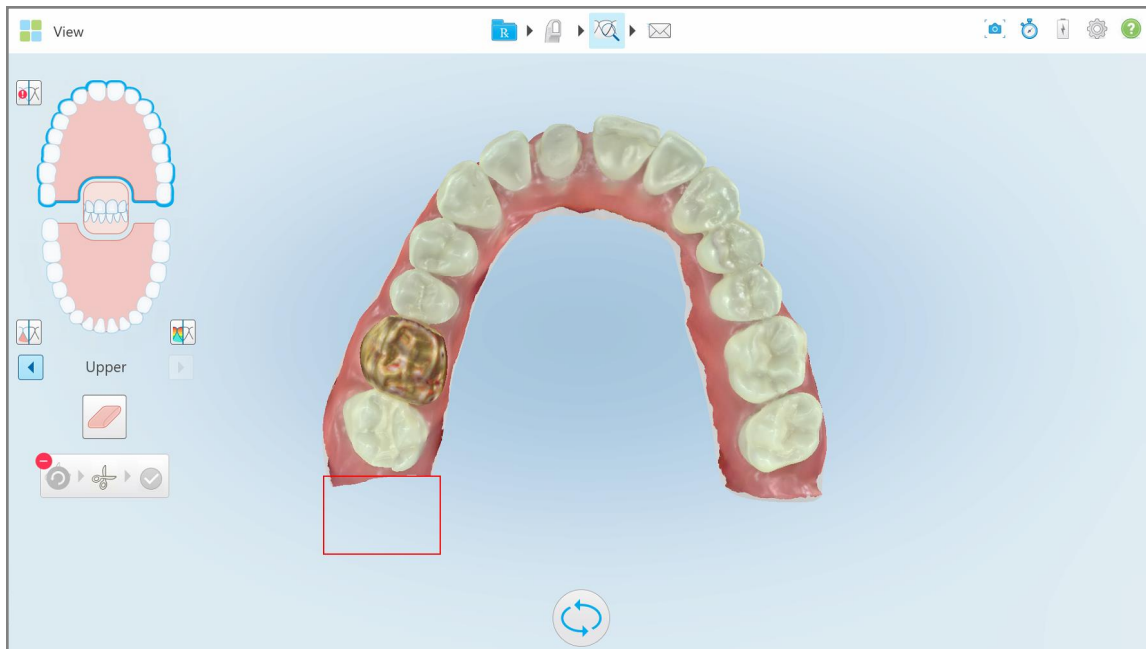

Figure 180: Selected area has been removed

10.10 Working with the Die Separation tool

The die separation is created automatically, according to the position of the green hint point, which must be located on the center of the prepped tooth after scanning.

If required, the die separation area can be edited or created manually.

To display the die separation:

1. After scanning the prepped tooth, ensure that the green hint point is centered on the prepped tooth. Move it manually, if required.

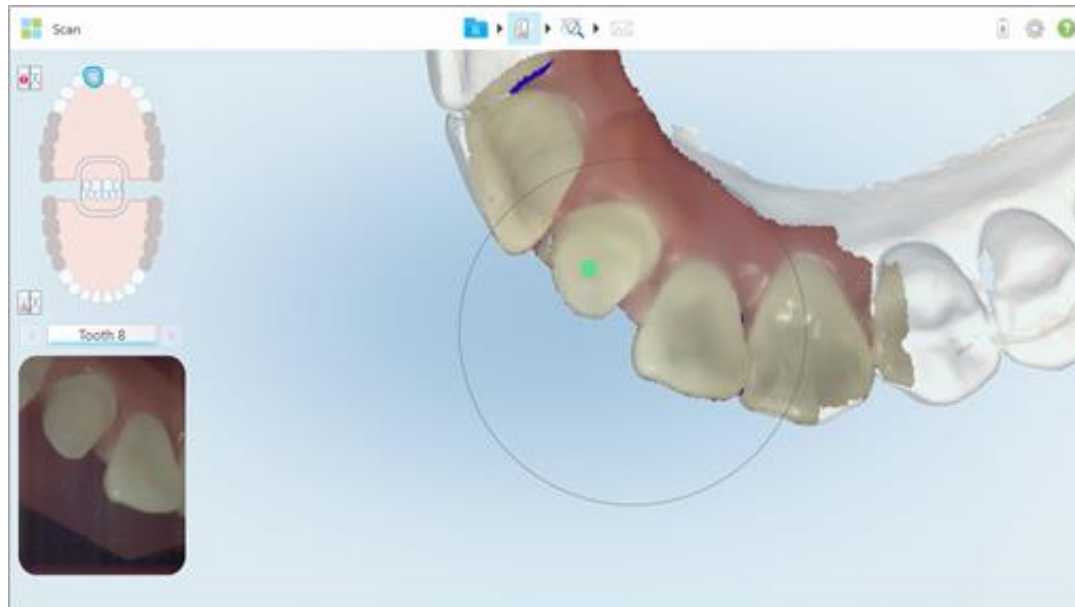



Figure 181: Green hint point centered on the prepped tooth

2. Tap  on the toolbar to move to **View** mode.
 3. In the *View* window, tap the Die Separation tool .
- The die separation is displayed in high resolution.

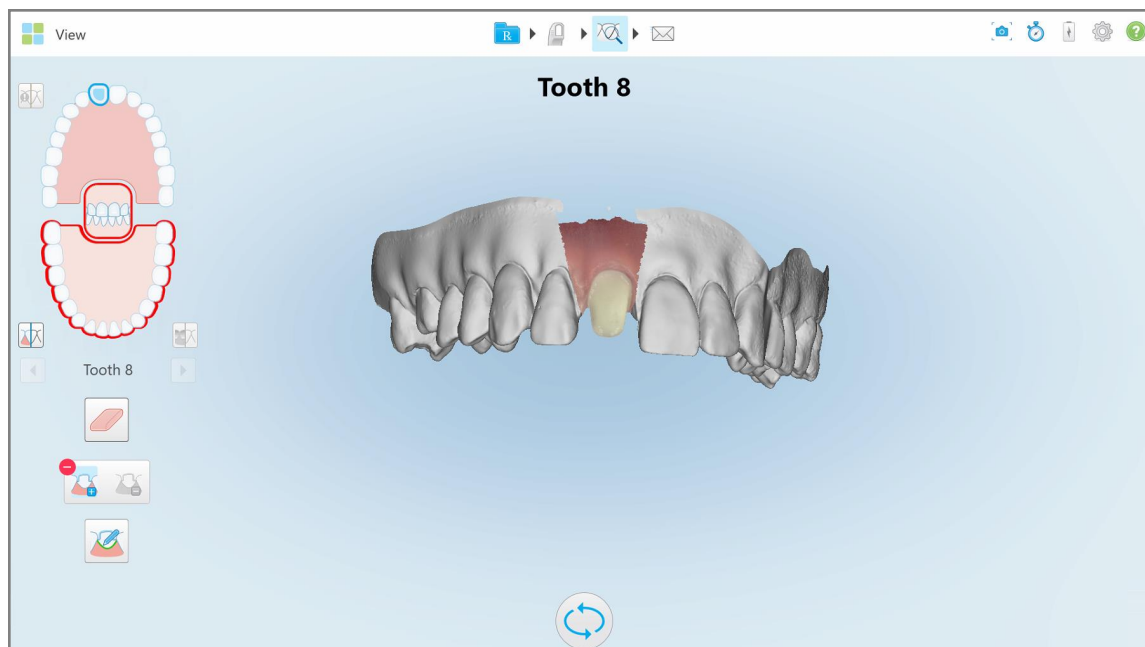



Figure 182: Die separation is displayed in high resolution

To create the die separation manually:

1. In the *View* window, tap the Die Separation tool .

The tool expands to show the following options:



Figure 183: Die Separation tool options

2. Tap  and mark the whole segment with your finger.

The scan is displayed in low resolution.

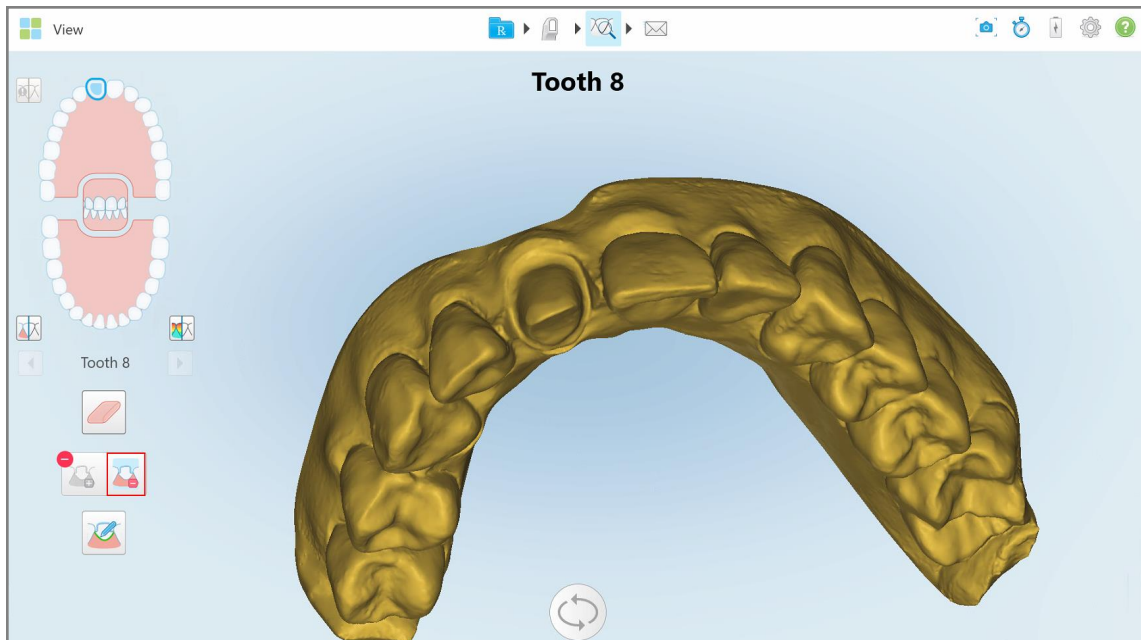



Figure 184: Scan is displayed in low resolution

- Tap  to mark the prepped tooth in high resolution.

The model is displayed as follows:

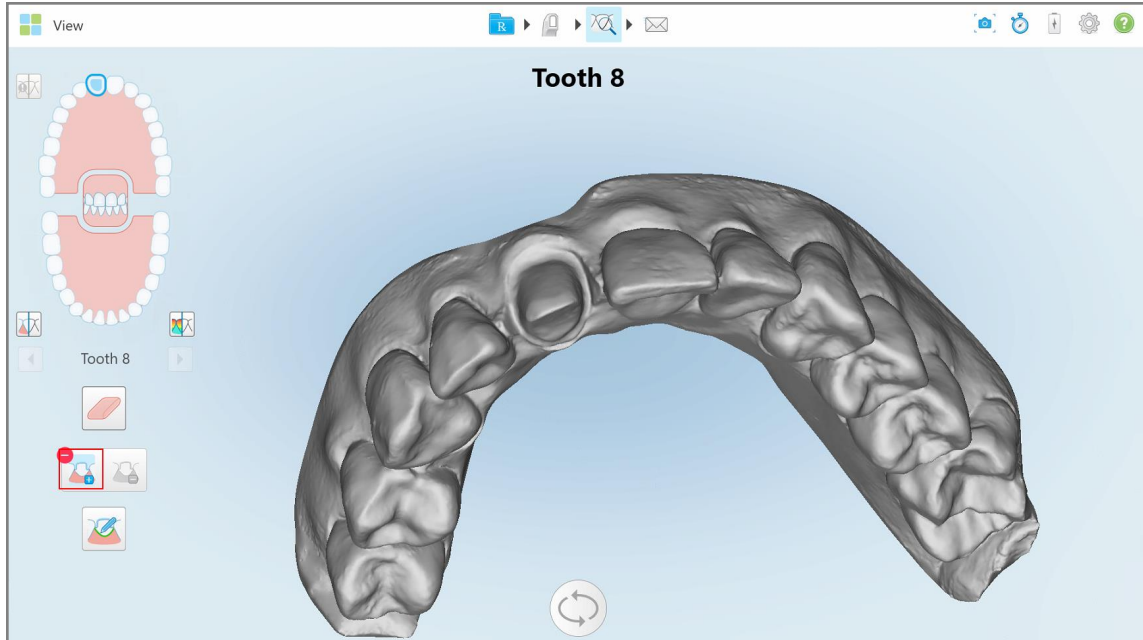

Figure 185: Before selecting the die separation

- Draw the area for the die separation.
- The selected area is displayed in high resolution.

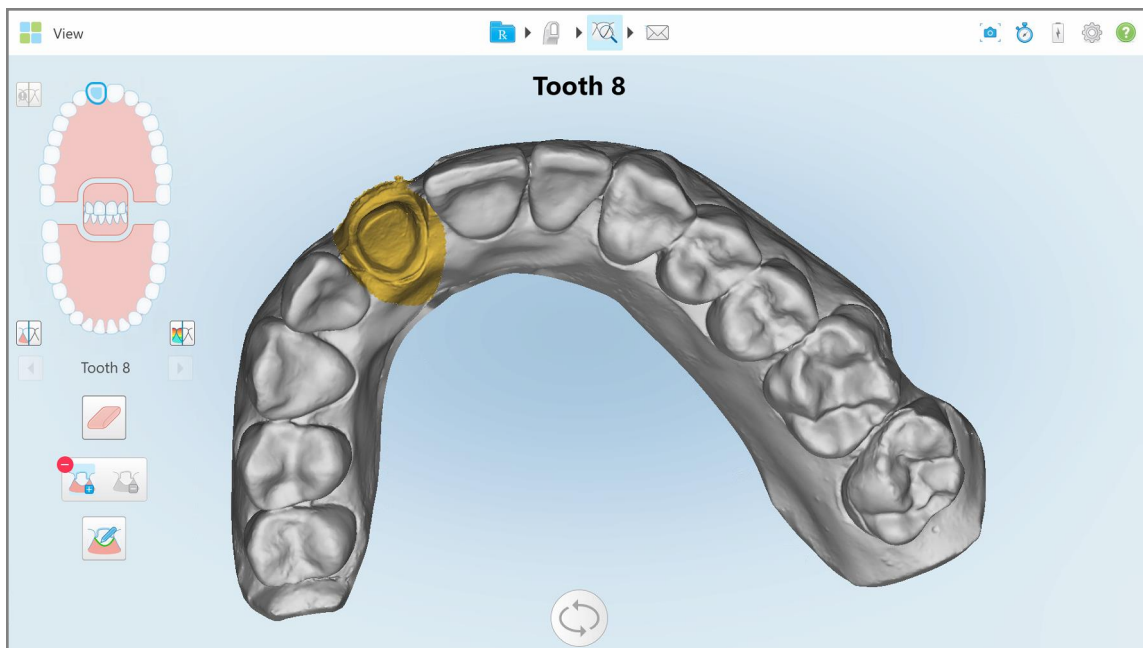

Figure 186: Prepped tooth is displayed in high resolution

10.11 Working with the Margin Line tool



The Margin Line tool automatically detects and marks the margin line on Fixed Restorative procedures that require crowns. If required, it can be marked manually for other indications. Once the margin line has been created, you can tweak it or recreate it if it has been deleted.

10.11.1 Automatically defining the margin line

The Margin Line tool automatically detects and marks the margin line on Fixed Restorative procedures that require crowns.

Note: The margin line may not be created automatically if:

- The prepped tooth was not scanned properly.
- The wrong die separation was used – the green dot was not centered on the prepped tooth while scanning – therefore part of the scan is not within the die separation area.

If the margin line cannot be created automatically, you will receive a message notifying you of this, and you can manually define the margin line, as described in [Manually defining the margin line](#).

To define the margin line automatically:

1. In the *View* window, tap the prepped tooth in the navigation controls.

The 3D model display moves to the occlusal view and zooms in on the prepped tooth.

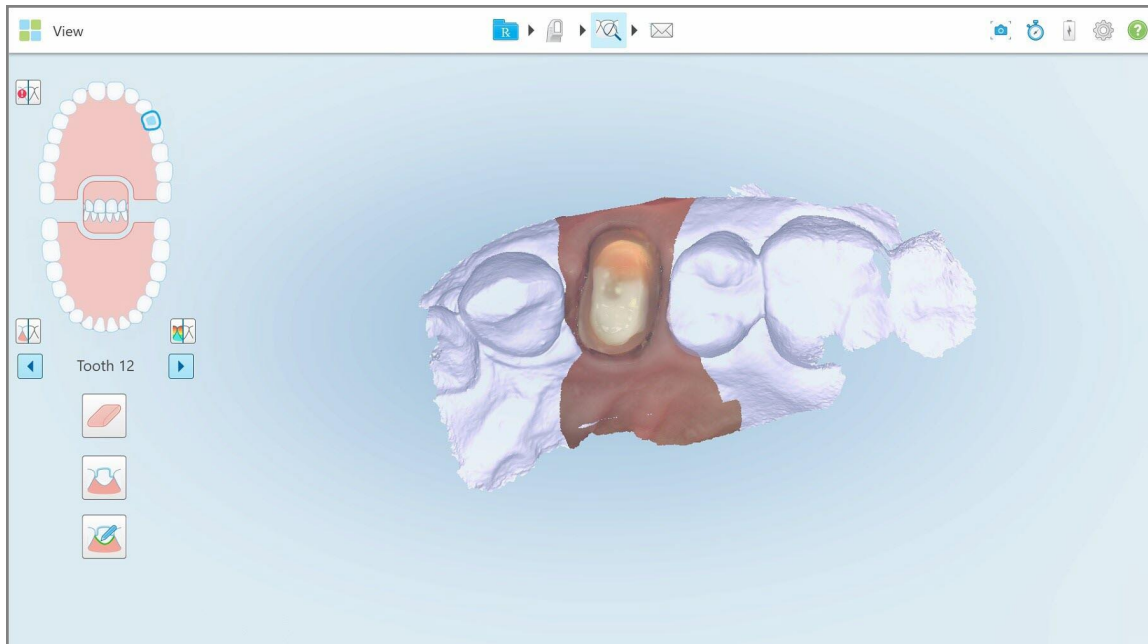

Figure 187: Model display moves to the occlusal view, and zooms in on the prepped tooth

2. Tap the Margin Line tool .

The Margin Line tool expands to show the following options:



Figure 188: Margin Line tool options

A message is displayed prompting you to wait while the automatic AI-based margin line is being detected. After a few seconds, the margin line is automatically marked on the prepped tooth. The teeth adjacent to the prepped tooth appear transparent, enabling you to see the edges of the margin line.

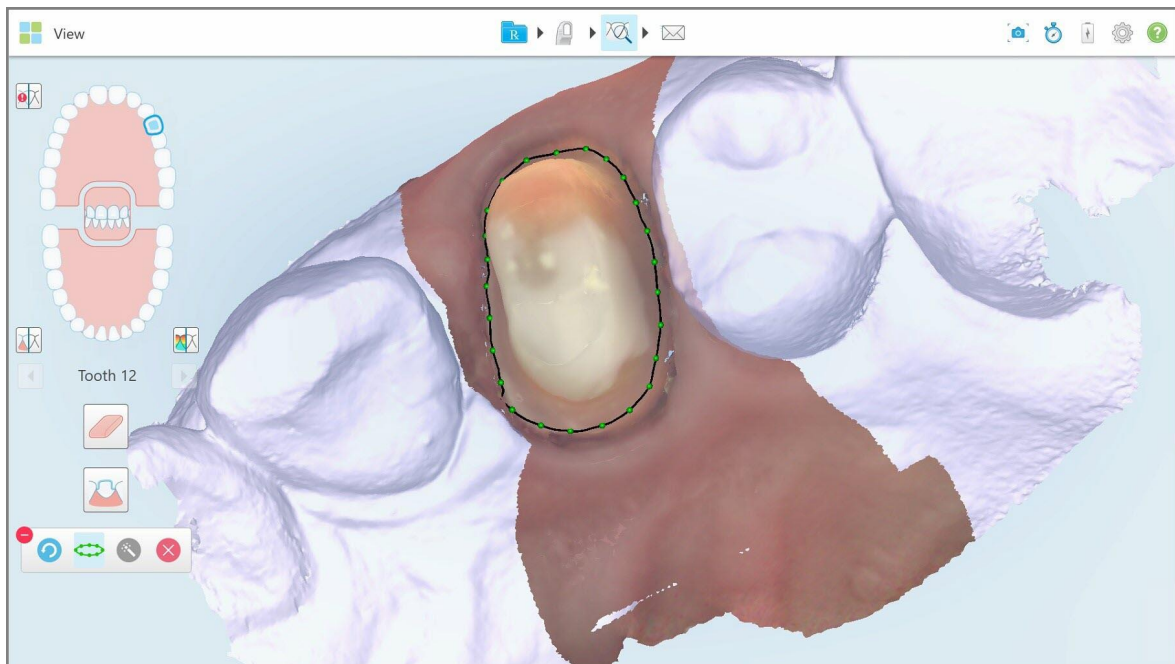





Figure 189: Margin line is marked on the prepped tooth

3. Tweak the margin line if required, by dragging any of the green control points.
4. If required, click  to undo the last action. You can click the button to undo the last 50 actions.
5. If required, click  to delete the margin line.
6. If required, click  to redisplay the deleted margin line.

10.11.2 Manually defining the margin line

If the margin line cannot be defined automatically, you can define it manually.

To define the margin line manually:

1. In the *View* window, tap the prepped tooth in the navigation controls.

The 3D model display moves to the occlusal view and zooms in on the prepped tooth.

2. Tap the Margin Line tool .

The Margin Line tool expands to show the following options:



Figure 190: Margin Line tool options

3. Tap  and then tap around the prepped tooth to draw a point-by-point line of at least 6–8 points.

Note: Make sure to close the margin line. If you do not complete the margin line and try sending the scan, you will receive a notification that the partial margin line will be deleted. You can go back and complete the margin line.

10.12 Working with the Snapshot tool

The Snapshot tool enables you to capture screenshots of the scanned model. These screenshots become part of the patient's export package and can later be downloaded from MyiTero. In addition, these screenshots can be added to the iTerio Scan Report, created in MyiTero.

Once the image has been captured, you can add annotations, if required.

By default, each time you tap the Snapshot tool, the following images are captured and saved in a separate folder, whose name includes the Order ID, and date and time of the screenshots:

- Entire View window
- 3D image
- 2D color viewfinder image (if the loupe has been dragged onto the 3D image)

Each set of screenshots is saved in a separate folder and saved in a folder with the patient's name, which can be downloaded from MyiTero as a zipped file.

Screenshots can be captured from any window that includes the Snapshot tool  on the scanner toolbar.

To capture a screenshot of a scanned image:

1. In **View** mode, tap the Snapshot tool  on the toolbar.

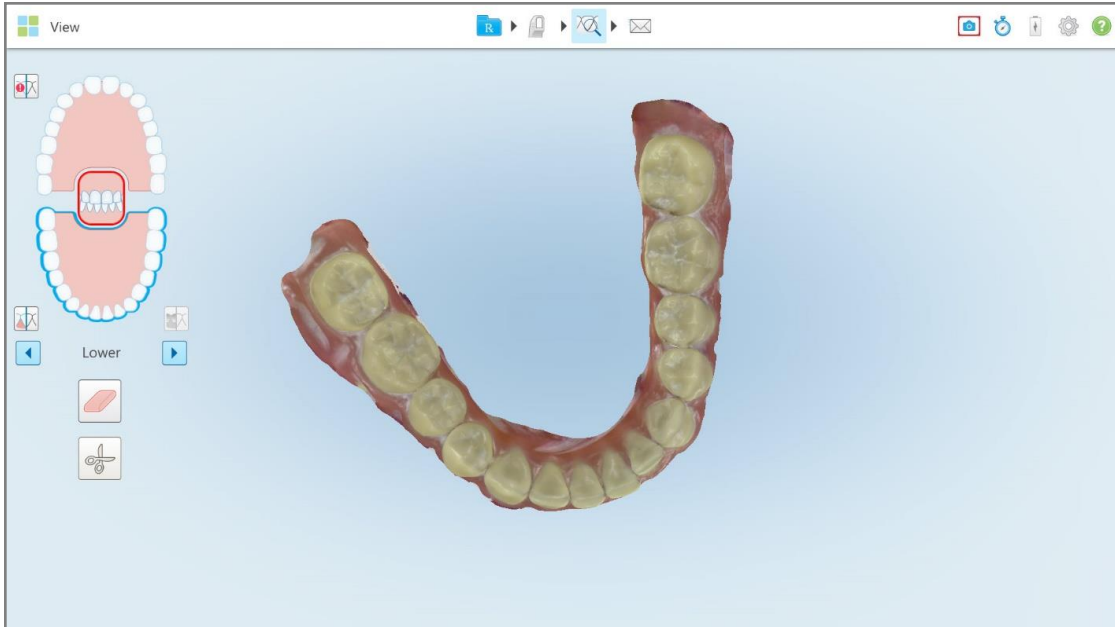

Figure 191: View mode – with Snapshot tool

The screen flashes, indicating that the screenshot was captured. A thumbnail of the screenshot is displayed on the bottom left of the window and remains for 7 seconds.

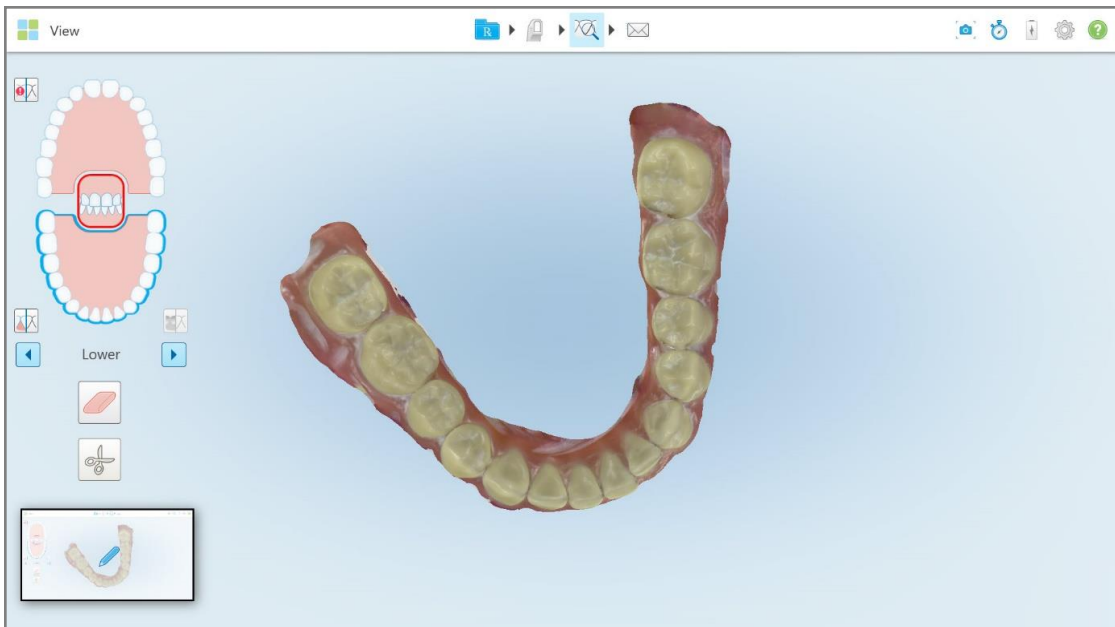

Figure 192: Screen capture thumbnail is displayed after taking a screen capture

2. Tap the thumbnail if you would like to add annotations to the screenshot.

The *Draw* window is displayed, showing a screenshot of the entire window, with an annotations toolbar on the top.

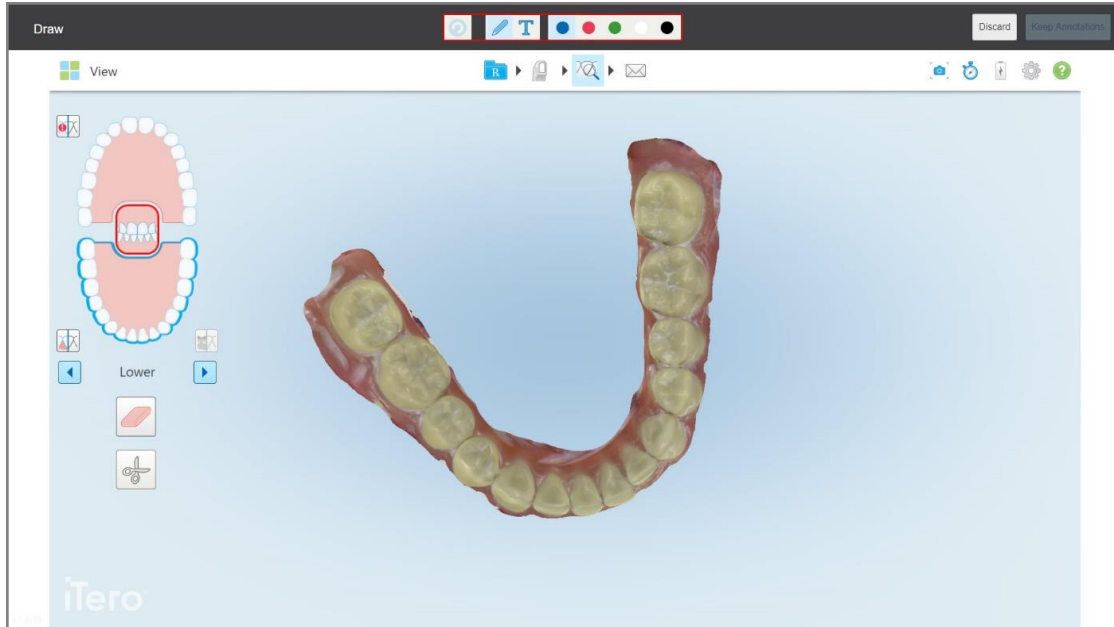

Figure 193: Screenshot with an annotations toolbar



Figure 194: Annotations toolbar

The annotations toolbar contains the following buttons:



Tap to undo previous annotations.



Tap to draw on the screenshot.



Tap to enter text on the screenshot.



Tap the color for the drawing and text. By default, these will be the same color.

3. Tap the required tool and color and then add your annotations. After adding text, tap  to save the text in the color selected.

Note: If you do not tap  after entering text, the color of the text will be changed if you select a different color for the next annotation.

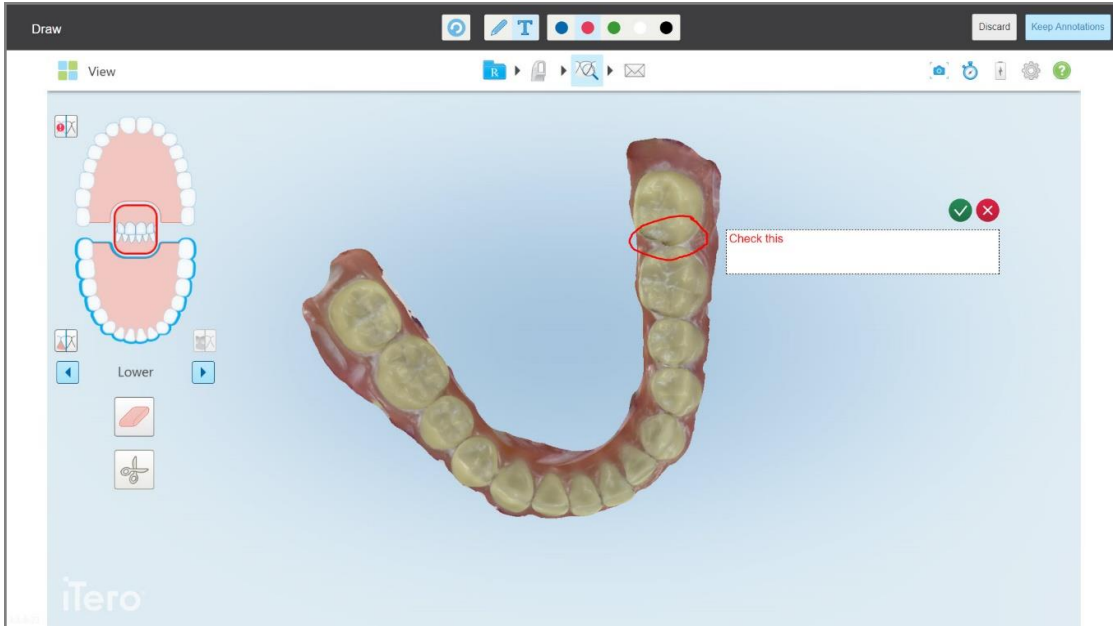

Figure 195: Adding text to the screenshot

- To save the screenshot with the annotations, tap **Keep Annotations**.

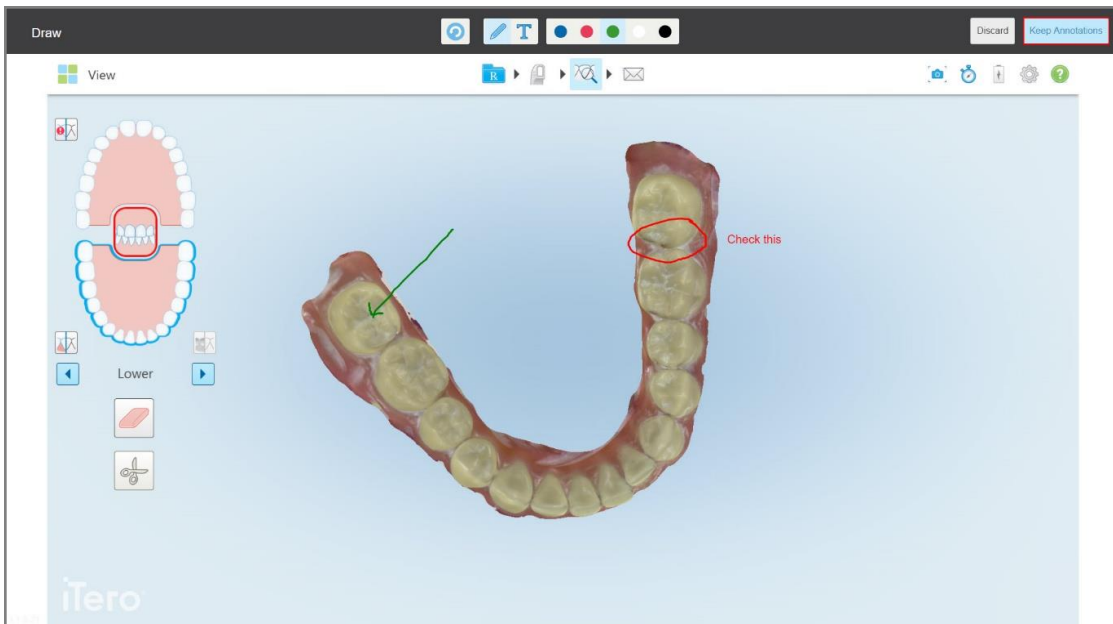

Figure 196: Screenshot with annotations

A pop-up message is displayed at the bottom of the screen, notifying you that the screenshots and annotations will be uploaded to MyiTero, where you can access them.

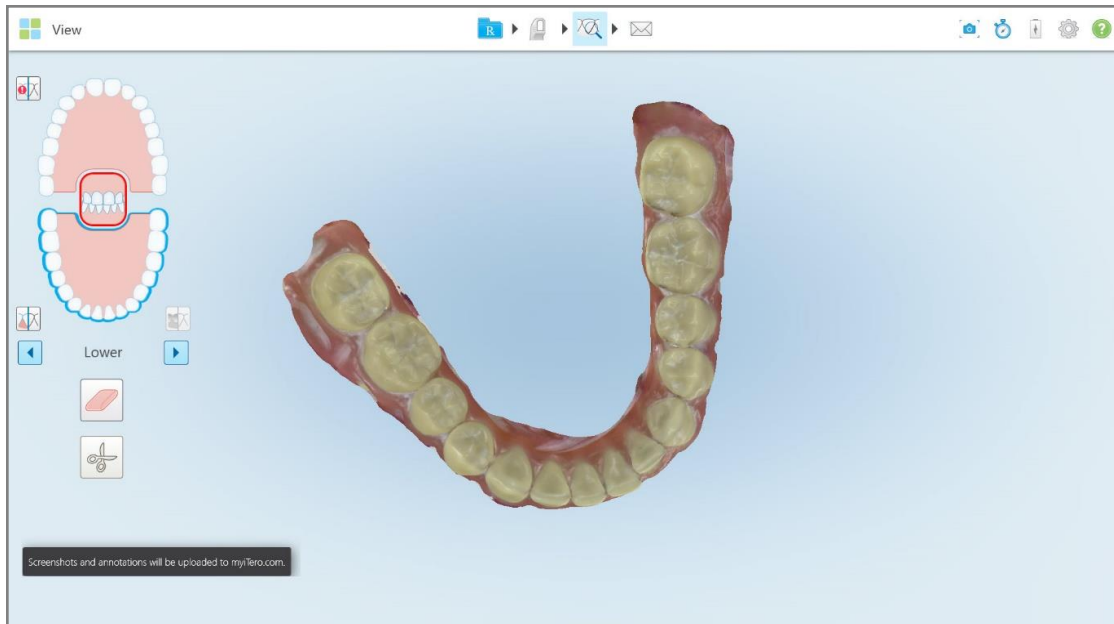

Figure 197: Notification that the screenshots and annotations will be uploaded to MyiTero

5. To save only the screenshots without the annotations, tap **Discard**.

A confirmation message is displayed.

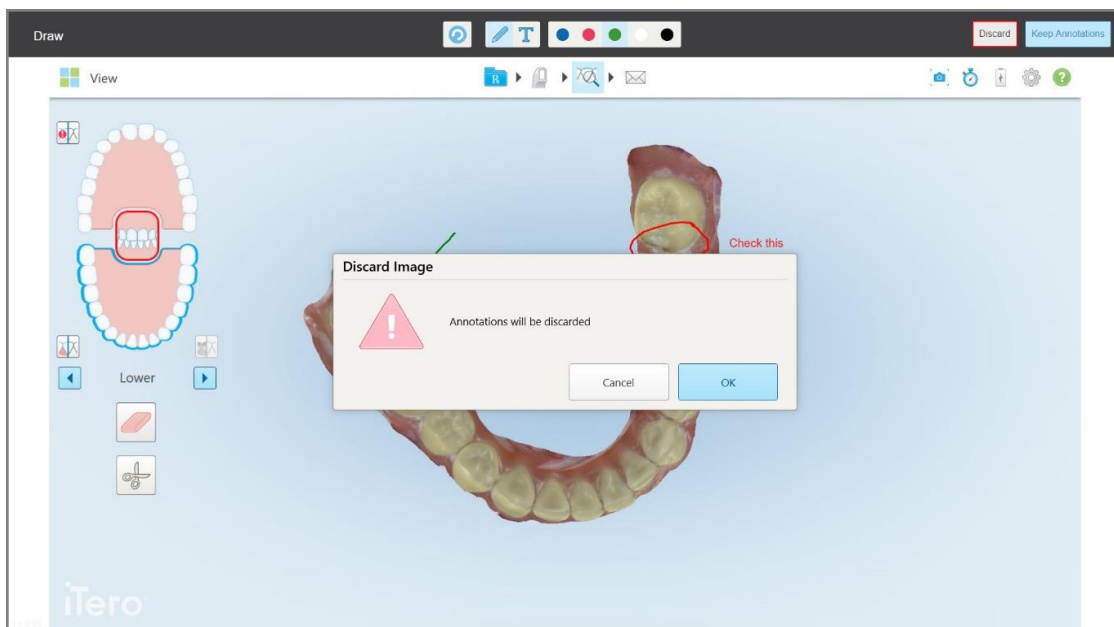

Figure 198: Confirmation about the annotations being discarded

a. Tap **OK** to proceed.

A pop-up message is displayed notifying you that the screenshots will be uploaded to MyiTero.

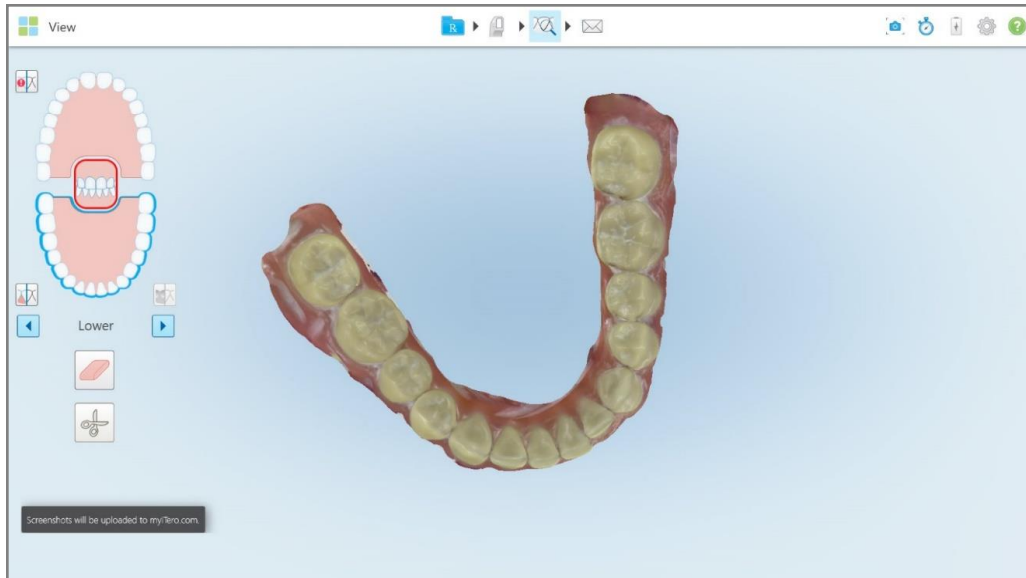

Figure 199: Notification that the screenshots will be uploaded to MyiTero

The screenshots can now be downloaded from MyiTero, from the *Orders* page, or from the *Viewer*.

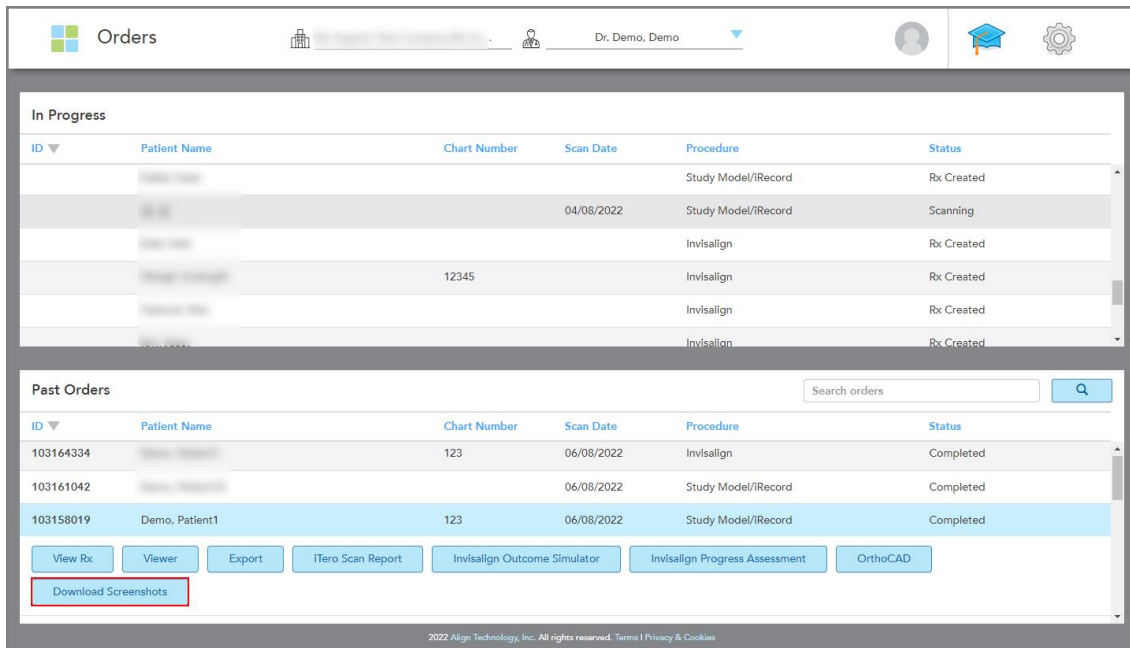

Figure 200: Option to download screenshots from the Orders page in MyiTero

11 Care and maintenance

If you are performing any sanitation procedures in the office that involve fogging or spraying, make sure that the iTerо scanner is not in the room.

To avoid cross-contamination, it is mandatory to:

- Clean and disinfect the scanner components, as described in the following sections.
- Replace the wand sleeve before each patient session, as described in [Applying a wand sleeve](#).
- Dispose of wand sleeves according to standard operating procedures or local regulations for the disposal of contaminated medical waste.
- Remove and replace gloves after each patient procedure.
- Discard torn, contaminated, or used gloves.

11.1 Handling the wand and cable

The wand contains delicate components and should be handled with care.

When not in use, the wand should be kept in its cradle, with the blue protective sleeve attached. If you have a laptop- or mobile-configuration scanner, the wand should be stored in the supplied carrying case or trolley, with the protective sleeve attached.

Between patients, undo any twists and knots in the wand cable in order to relieve all tension. If the cable cap detaches from the wand, gently reattach it.

11.2 Cleaning and disinfecting the wand

The iTerо wand requires the procedures in the following sections for cleaning and disinfection.

These procedures must be carried out:

- After the scanner assembly, before first-time use
- Between patients

Warning: Avoid deviating from the recommended cleaning and disinfection process, and modifying or substituting recommended materials to prevent biological hazards.

You must follow all the cleaning and disinfecting steps below to ensure that the wand is properly reprocessed and ready for use.

11.2.1 Preparation before cleaning and disinfection

1. To avoid false activation of the wand during the cleaning and disinfection procedures, make sure to exit a scan completely by sending the scan or by going back to the home screen.
2. Remove the wand sleeve, making sure not to touch the optical surface of the wand.

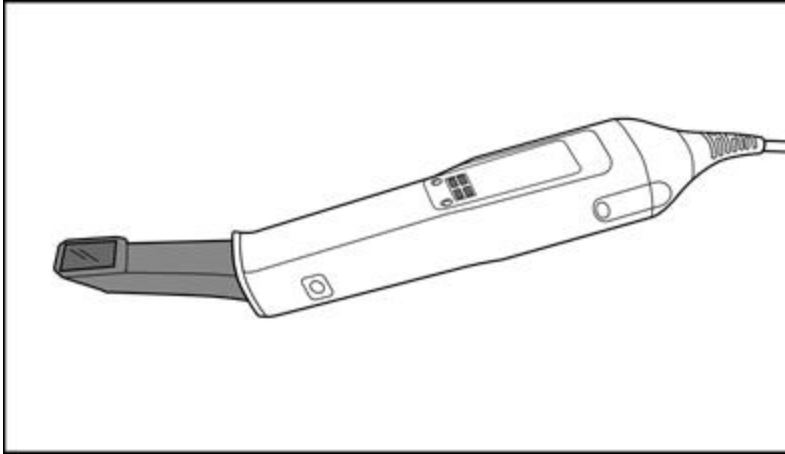

Figure 201: Wand without a sleeve

3. Visually inspect the wand for any noticeable damage, for example, deterioration such as corrosion, discoloration, pitting, or cracks.

Warning: Do not clean, disinfect, or use the wand if any damage is found. Please contact iTero Customer Support for further instructions.

4. Prepare the following:
 - Required cleaning and disinfecting materials:
 - CaviWipes1 (or, for a list of alternative materials and the required contact time, see [Approved cleaning and disinfecting materials](#))
 - 70% isopropyl alcohol (IPA)
 - Dry lint-free wipes
 - Soft bristle brush (e.g. the smaller end of a Healthmark Trumpet Valve Brush 1mm diameter, Cat # 3770 or equivalent)
 - Personal Protective Equipment (PPE) and work environment
 - Please follow the cleaning and disinfection material manufacturers' instructions

Note: Replace cleaning and disinfection materials (brushes/wipes) if visibly damaged or soiled.

Before starting the cleaning and disinfection procedure, put on your PPE.

11.2.2 Wand cleaning and disinfection

Before cleaning and disinfecting the wand, ensure that the sleeve has been removed.

Cleaning

1. Using CaviWipes¹, remove any gross contaminants on the wand body and wand tip for a minimum of one (1) minute.

Note: If you are using an alternative disinfectant, please refer to [Approved cleaning and disinfecting materials](#) for the required contact time.

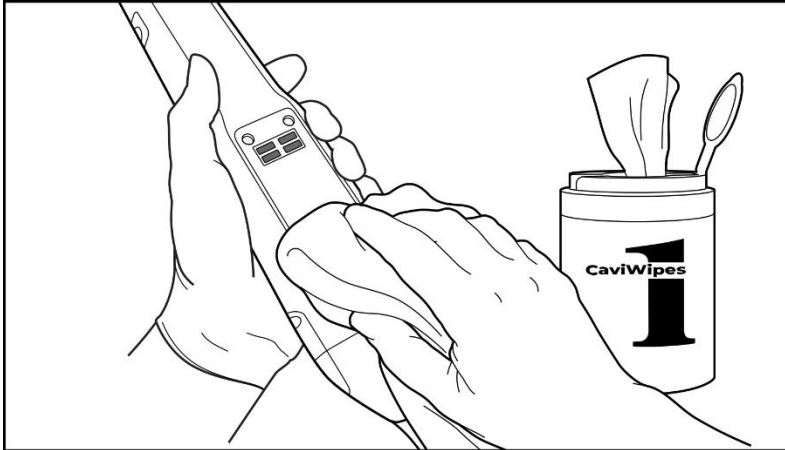

Figure 202: Remove gross contaminants using CaviWipes¹

2. Using the soft bristle brush, remove any remaining marks and stains on the wand body and wand tip, paying special attention to the grooves, indents, joints, vents, etc. Brush until visibly clean.

CAUTION: Do not use the brush on the optical surface to prevent damage to the wand.

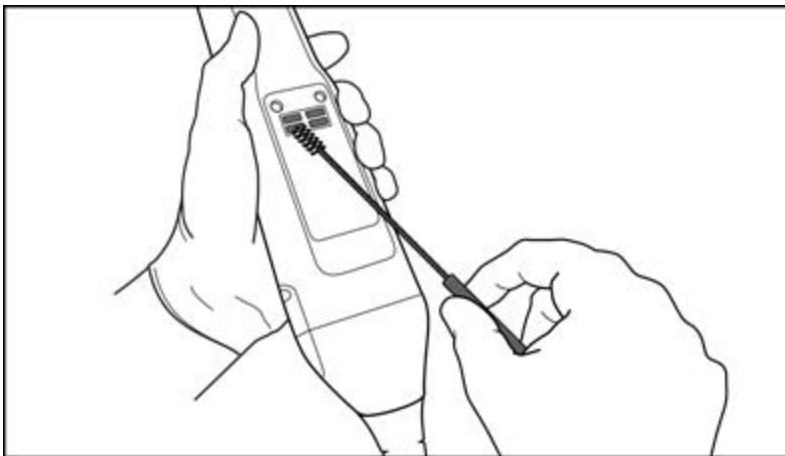

Figure 203: Remove marks and stains using a soft bristle brush

3. Using CaviWipes¹, remove any remaining contaminants on the wand body and wand tip.
4. Visually inspect the device in a well-lit area to ensure all surfaces are visibly clean.

Disinfection

1. Using CaviWipes¹, thoroughly dampen all external surfaces of the wand body and wand tip, including the optical surface and ensure they remain wet for a minimum of one (1) minute.

Note: Use multiple fresh wipes, as necessary, to keep the wand surfaces wet for the full one (1) minute contact time.

3. Using lint-free wipe(s) wetted (but not dripping) with 70% Isopropyl Alcohol (IPA), thoroughly wipe the optical surface of the wand one (1) time until visibly clean.

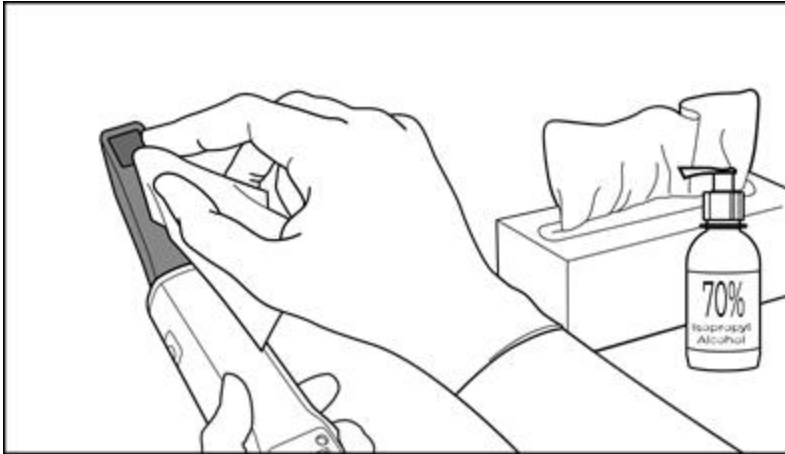

Figure 204: Wipe the optical surface of the wand with IPA

4. Wait until the optical surface dries (approximately 5–10 seconds).
5. Remove any residue from the optical surface using a dry lint-free wipe.

11.2.3 Drying – wand body

Air-dry the disinfected wand at room temperature.

11.2.4 Storage and maintenance

1. Visually inspect the wand for any noticeable damage, for example, deterioration such as corrosion, discoloration, pitting, or cracks. Pay special attention to the optical surface, making sure it remains clean.

Warning: Do not use the wand if any damage is detected. Please contact iTero Support for further instructions.

2. Place the blue protective sleeve on the wand tip.
3. Place the wand in the cleaned and disinfected cradle, as described in [Cleaning and disinfecting the cradle](#), below.
4. If you have a laptop- or mobile-configuration scanner, store the wand in the carrying case or trolley when not in use.

11.3 Cleaning and disinfecting the cradle

The wand cradle requires the procedures in the following sections for cleaning and disinfection.

These procedures must be carried out:

- After the scanner assembly, before first-time use
- Between patients

Warning: Avoid deviating from the recommended cleaning and disinfection guidelines, and modifying or substituting recommended materials, to prevent biological hazards.

You must follow all the cleaning and disinfecting steps below to ensure that the cradle is properly reprocessed and ready for use.

11.3.1 Preparation before cleaning and disinfection

1. Visually inspect the cradle for any noticeable damage, for example, deterioration such as discoloration, pitting, or cracks.

CAUTION: Do not clean, disinfect, or use the cradle if any damage is detected. Please contact iTerо Customer Support for further instructions.

2. Prepare the following:

- Required cleaning and disinfecting materials:
 - CaviWipes1 (or, for a list of alternative materials and the required contact time, see [Approved cleaning and disinfecting materials](#))
 - Soft bristle brush (e.g. the smaller end of a Healthmark Trumpet Valve Brush 1mm diameter, Cat # 3770 or equivalent)
- PPE and work environment
 - Please follow the cleaning and disinfecting material manufacturers' instructions.

Note: Replace cleaning and disinfection materials (brushes/wipes) if visibly damaged or soiled.

Before starting the cleaning and disinfection procedure, put on your PPE.

11.3.2 Cradle cleaning and disinfection

Cleaning

1. Using CaviWipes1, remove any gross contaminants on the cradle for a minimum of one (1) minute.

Note: If you are using an alternative disinfectant, please see [Approved cleaning and disinfecting materials](#) for the required contact time.

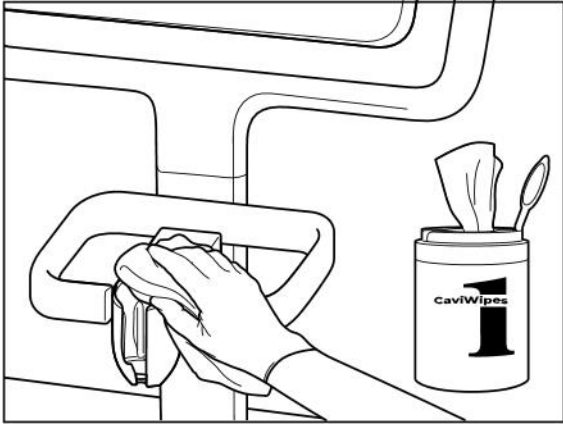

Figure 205: Wiping the iTero Element 2 cradle

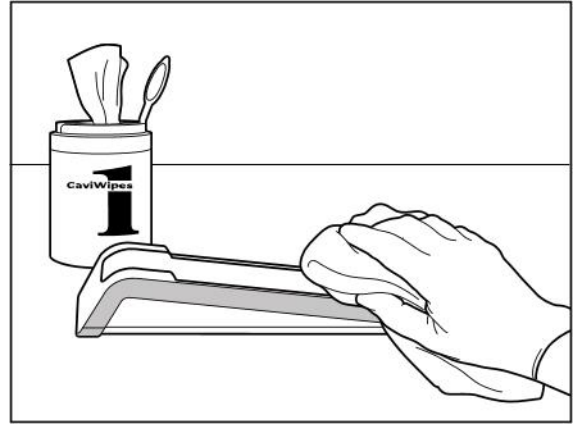

Figure 206: Wiping the iTero Element Flex cradle

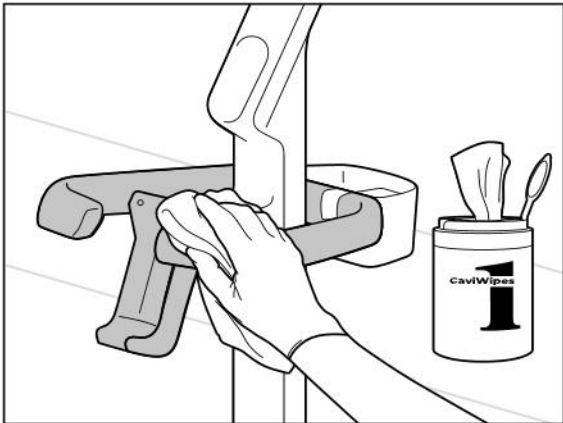

Figure 207: Wiping the iTero Element 2 Plus cart-configuration cradle



Figure 208: Wiping the iTero Element 2 Plus mobile-configuration cradle

2. Using the soft bristle brush, remove any remaining marks and stains on the cradle, paying special attention to the grooves, indents, joints, etc.

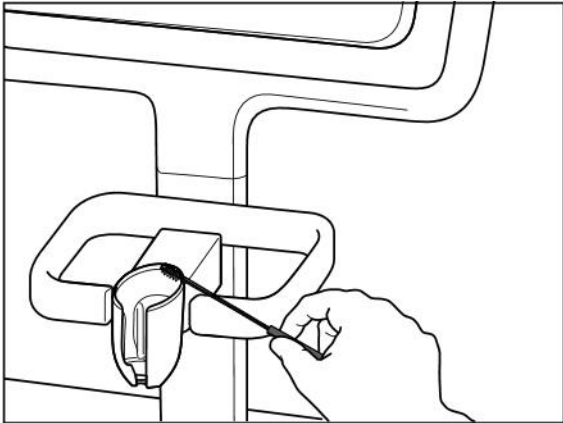

Figure 209: Brushing the iTerо Element 2 cradle

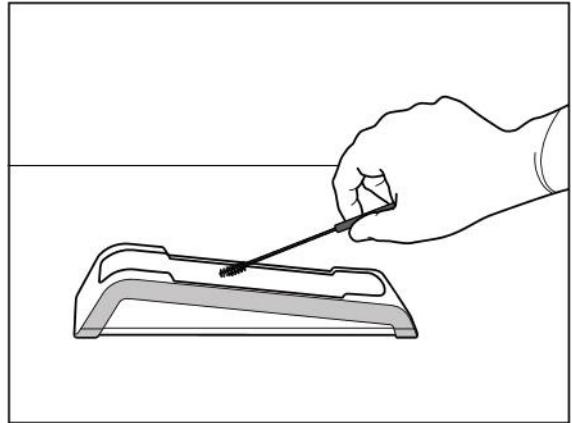

Figure 210: Brushing the iTerо Element Flex cradle

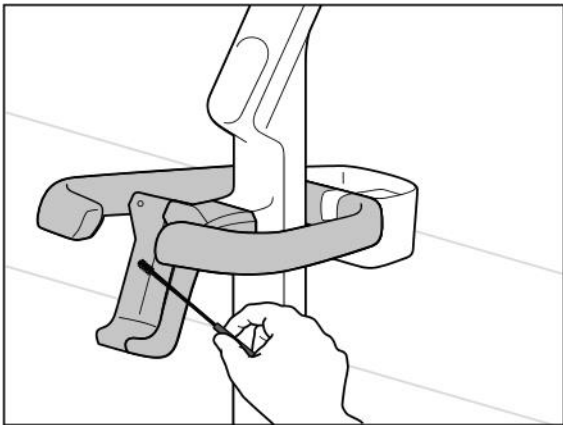

Figure 211: Brushing the iTerо Element 2 Plus cart-configuration cradle

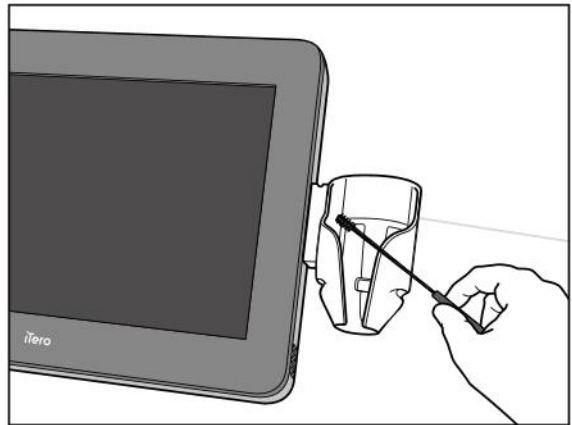

Figure 212: Brushing the iTerо Element 2 Plus mobile-configuration cradle

3. Using CaviWipes¹, remove any remaining contaminants on the cradle.
4. Visually inspect the cradle in a well-lit area to ensure all surfaces are visibly clean.

Disinfection

- Using CaviWipes¹, thoroughly dampen all external surfaces of the cradle and ensure they remain wet for a minimum of one (1) minute.

Note: Use multiple fresh wipes, as necessary, to keep the cradle surfaces wet for the full one (1) minute contact time.

11.3.3 Drying – cradle

Air-dry the disinfected cradle at room temperature.

11.3.4 Storage and maintenance

Visually inspect the cradle for any noticeable damage, for example, deterioration such as discoloration, pitting, or cracks.

Warning: Do not use the cradle if any damage is detected. Please contact iTero Customer Support for further instructions.

The iTero Element Flex cradle should be stored in the carrying case when not in use.

11.4 Cleaning and disinfecting the scanner touch screen and the wheel-stand handle

The scanner screen and wheel-stand handle must be cleaned between patients, as follows:

1. Clean all outer surfaces using approved disinfectant wipes, or approved disinfectant liquid with a clean lint-free wipe, and follow the manufacturer's instructions. For a list of approved materials, see [Approved cleaning and disinfecting materials](#).
2. Remove any residual liquid disinfectant with a clean lint-free wipe.

Note: Do not use abrasive cleaners and/or corrosive cleaning agents or disinfectants with acids, bases, oxidizing agents, or solvents.

11.5 General cleaning

All scanner parts and accessories not outlined above should be cleaned according to standard operating procedures or local regulations.

In addition to the processes described above, national standards and regulatory requirements may apply.

11.6 Approved cleaning and disinfecting materials

The following table lists the Align-recommended cleaning and disinfecting materials, as well as the minimum contact time required.

If you are using a liquid disinfectant, soak a clean, sterile, lint-free wipe in the liquid and squeeze until moist, and then follow the cleaning and disinfection instructions described in this document.

Material	Active Ingredient	Contact time (minutes)
CaviWipes1/CaviCide1	Quats-alcohol	1
CaviWipes/CaviCide	Quats-alcohol	3
Clorox HP Wipes	1.4% Hydrogen Peroxide	5
Oxivir® 1 Wipes	AHP Hydrogen Peroxide	1
Clinell Universal Range Wipes	≤50% Peracetic Acid	2

Note: If the recommended alternative disinfectants are not available in your region, consult your local supplier of disinfecting materials for equivalent products in your region. Equivalent products must meet local regulatory requirements, have the same active ingredients, and in addition, must be able to disinfect against at least Hepatitis and Tuberculosis.

A Clinic LAN network guidelines

A.1 Introduction

The scanner is capable of connecting to the wireless LAN in order to support the file transfer to and from the iTero cloud. Connection to other wireless devices is not supported.

Below are some helpful guidelines for the best Wi-Fi connection.

Levels of Wi-Fi Internet Connectivity



Excellent

>-50 dBm



Good

-50 to -60 dBm



Fair

-60 to -70 dBm



Weak

<-70 dBm

IMPORTANT: In order to achieve the best performance of your iTero scanner, ensure that the Wi-Fi signal strength is Excellent or at least Good.

Warning: Never connect the LAN cable to the scanner, in order to prevent electrical shock.

A.2 Preparations

- The required modem/router should be configured with the WPA2 security standard, including a password.
- Ensure that your IT professional staff will be available when the scanner installation is planned to take place.
- Make sure that the Wi-Fi SSID credentials are available: Login & password.
- The minimum Wi-Fi strength signal for the system should display at least three lines, as shown above.
- Following are some suggestions for the office IT personnel, regarding what should be considered in order to prevent issues such as access or connectivity to/with the iTero scanner:
- Hostname recommendations related to Align services listening to port 443, as described in [Align hostname recommendations](#).
- Do not prevent FTP communication since the scanner sends specific file types (.3ds and .3dc/.3dm).
- Disable any proxy clients for data communication through TCP/IP.
- Do not add the scanner to any domain group.
- Do not run any group policy on the scanner as it may disrupt its proper functioning.

A.3 Router guidelines

Minimum standards: 802.11N / 802.11AC

A.4 Internet connection guidelines

In order to achieve the best performance of your iTerio scanner, ensure that the internet connection upload speed is at least 1Mbps per scanner. Also, note that any additional devices connected to the internet in parallel to the scanner may affect the scanner's performance.

A.5 Firewall

Open the following port (in case of a firewall):

- 443 - HTTPS - TCP

A.6 Wi-Fi tips

Wi-Fi routers allow you to access the internet system using a Wi-Fi connection from essentially any place within the functional range of the wireless network. Nevertheless, the number, depth, and position of walls, ceilings, or additional partitions that the wireless signals must travel through may limit the range and strength of the signal. Normal signals vary, depending on the material types and background RF (radio frequency) noise in your home or business.

- Be sure to have a minimal number of walls and ceilings between the router and other network devices. Each barrier can reduce the adapter's range by 1-3 meters (3-9 feet).
- Be sure to have a straight line, free of any partition, between network devices. Even a wall that seems rather thin can block a signal of 1 meter (3 feet) if the wall angle is shifted by only 2 degrees. To achieve the best reception, place all the devices so that the Wi-Fi signal travels straight through a wall or partition (instead of at an angle).
- Construction materials make a difference. A solid metal door, or aluminum nails, can be very dense and may have an adverse effect on a Wi-Fi signal. Try to position access points, wireless routers, and computers so that the signal travels through drywalls or open doorways. Materials and objects such as glass, steel, metal, walls with insulation, water tanks (aquariums), mirrors, file cabinets, brick, and concrete may reduce the wireless signal.
- Keep the scanner away (at least 3-6 feet or 1-2 meters) from electrical devices or appliances that generate RF noise.
- If you are using 2.4GHz cordless phones or X-10 (wireless products such as ceiling fans, remote lights, and home security systems), the wireless connection may be severely degraded or entirely drop. The base of many wireless devices transmits an RF signal, even if the device is not in use. Position any other wireless devices as far as possible from the scanner and router.
- In your area, there may be more than one active wireless network. Each network uses one or more channels. If the channel is near your system channels, the communication may gradually decline. Ask your IT department to check this, and if required, change the channel numbers used by your network.

A.7 Align hostname recommendations

Align constantly improves its products and services, and can therefore commit to a Hostname, rather than a specific IP address.

The following list of hostnames was created to provide Align's scanners the proper operation functions, in order to be able to utilize all the advanced capabilities of the scanner performance.

Align hostname recommendation:

Hostname	Port
Mycadent.com	443
Myaligntech.com	443
Export.mycadent.com	443
Cbserver.mycadent.com	443
Matstore3.invisalign.com	443
Matstoresg.invisalign.com	443
Matstorechn.invisalign.com.cn	443
AWS IP range - Amazon global CDN service - IP address range varies depending on the location of the scanner.	443
cloud.myitero.com	443
https://itero-scanner-speed-test-prd.s3-accelerate.amazonaws.com/	443
alignapi.aligntech.com	443
https://www.google.com	443
https://www.microsoft.com	443
https://www.yahoo.com	443
iterosec.aligntech.com	443
storage.cloud.aligntech.com	443
http://*.trendmicro.com	443
https://*.trendmicro.com	8080, 21112

B EMC declarations

B.1 EMC declaration – iTeror Element 2 and iTeror Element Flex

IEC 60601-1-2 Edition 4.0 (2014)

Medical electrical equipment; Part 1-2: General requirements for basic safety and essential performance - Collateral Standard: Electromagnetic disturbances - Requirements and tests.

CFR 47 FCC

Rules and Regulations:
Part 15. Radio frequency devices.
Subpart B: Unintentional radiators (2015)

ETSI EN 301 489-1, ETSI EN 301 489-17 (relevant for iTeror Element 2 only)

Electromagnetic Compatibility (EMC) standard for radio equipment and services; Part 1: Common technical requirements

Environment for intended use

Professional Healthcare and Home Healthcare Facility Environment

The iTeror Element 2 and iTeror Element Flex intraoral scanner essential performances are:

- Display viewfinder and 3D imaging without interference on the touch screen.
- Stored scan data is accessible and can be displayed.

Note: Due to electromagnetic disturbance, in some cases, the image may disappear and a non-communication message will appear on the touch screen. The scanner will return to operation mode after user intervention or auto-recovery.

The following is a summary of the EMC test results for iTeror Element 2 and iTeror Element Flex scanners:

Test	Standard	Class / Severity level	Test results
Emission (IEC 60601-1-2 section 7)			
Conducted emission Freq. range: 150 kHz - 30 MHz	CISPR 11	Group 1 Class B on 230, 220, 120 & 100 VAC mains @ 50 Hz; 220 VAC mains @ 60 Hz	Complies
Radiated emission Freq. range: 30 - 1000 MHz	CISPR 11	Group 1 Class B	Complies
Harmonic current emission test	IEC 61000-3-2	230 VAC mains @ 50 Hz & 220 V @ 50 Hz & 60 Hz	Complies
Voltage changes, Voltage fluctuations and Flicker test	IEC 61000-3-3	230 VAC mains @ 50 Hz & 220 VAC mains @ 50 Hz	Complies

Test	Standard	Class / Severity level	Test results
Immunity (IEC 60601-1-2 section 8)			
Immunity from Electrostatic discharge (ESD)	IEC 61000-4-2	8 kV contact discharges & 15 kV air discharges	Complies
Immunity from radiated electromagnetic fields	IEC 61000-4-3	10.0 V/m; 80 MHz ÷ 2.7 GHz, 80% AM, 1 kHz	Complies
Immunity from Proximity field from wireless communications equipment	IEC 61000-4-3	List of frequencies, from 9 V/m up to 28 V/m, PM (18 Hz or 217 Hz), FM 1 kHz	Complies
Immunity from Electrical Fast transient (EFT)	IEC 61000-4-4	± 2.0 kV on 230 VAC @ 50 Hz; & 220 VAC mains @ 60 Hz; Tr/Th – 5/50 ns, 100 kHz	Complies
Immunity from Surge	IEC 61000-4-5	±2.0 CM / ±1.0 kV DM on 230 VAC mains @ 50 Hz; & 220 VAC mains @ 60 Hz; Tr/Th – 1.2/50 (8/20) ms	Complies
Immunity from conducted disturbances induced by radio-frequency fields	IEC 61000-4-6	3.0, 6.0 VRMS on 230 VAC mains @ 50 Hz & 220 VAC mains @ 60 Hz & Wand cable; 0.15÷ 80 MHz, 80% AM @ 1 kHz	Complies
Immunity from voltage dips, short interruptions and voltage variations	IEC 61000-4-11	On 230 VAC & 100 VAC mains @ 50 Hz: 0 % - 0.5 cycle & 1 cycle; 70% - 25 cycles; 0% - 250 cycles; on 220 VAC mains @ 60 Hz: 0 % - 0.5 cycle & 1 cycle; 70% - 30 cycles; 0% - 300 cycles	Complies

Test	Standard	Class / Severity level	Test results
Emission (per ETSI EN 301 489-1, ETSI EN 301 489-17)			
(relevant for iTero Element 2 only)			
Conducted emissions on mains terminals in freq. range 150 kHz - 30 MHz	ETSI EN 301 489-1; ETSI EN 301 489-17 / EN 55032	Group 1 Class B 230 VAC mains	Complies
Radiated emissions in freq. range 30 - 6000 MHz	ETSI EN 301 489-1; ETSI EN 301 489-17 / EN 55032	Class B	Complies
Harmonic current test	ETSI EN 301 489-1; ETSI EN 301 489-17 / EN 61000-3-2	230 VAC mains	Complies
Flicker tests	ETSI EN 301 489-1; EN 61000-3-3	230 VAC mains	Complies
Immunity (per ETSI EN 301 489-1, ETSI EN 301 489-17)			
(relevant for iTero Element 2 only)			
Immunity from Electrostatic discharge (ESD)	EN 61000-4-2	4 kV contact discharge 8 kV air discharge	Complies
Immunity from radiated electromagnetic fields	EN 61000-4-3	3.0 V/m, 80 MHz , 6.0 GHz, 80% AM, 1 kHz	Complies
Immunity from Electrical Fast transient (EFT)	EN 61000-4-4	AC mains: ± 1.0 kV; Tr/Th – 5/50 ns, 5 kHz	Complies
Immunity from Surge	EN 61000-4-5	AC mains: ± 1.0 kV DM / ± 2.0 kV CM, Tr/Th – 1.2/50 (8/20) ms	Complies
Immunity from conducted disturbances induced by radio-frequency fields	EN 61000-4-6	AC mains: 3.0 VRMS; 0.15+80 MHz, 80% AM @ 1 kHz	Complies
Immunity from Voltage interruptions	EN 61000-4-11	AC mains: 0% - 0.5 cycle & 1 cycle; 70% - 25 cycles; 0% - 250 cycles	Complies

B.2 EMC declaration – iTero Element 2 Plus

IEC 60601-1-2 Edition 4.0 (2014)/EN 60601-1-2 (2015)

Medical electrical equipment; Part 1-2: General requirements for basic safety and essential performance - Collateral Standard: Electromagnetic disturbances - Requirements and tests.

CFR 47 FCC

Rules and Regulations:
Part 15. Radio frequency devices.
Subpart B: Unintentional radiators (2020)

ETSI EN 301 489-1, ETSI EN 301 489-17

Electromagnetic Compatibility (EMC) standard for radio equipment and services

Environment for intended use

Professional Healthcare and Home Healthcare Facility Environment

The iTero Element 2 Plus intraoral scanner essential performances are:

- Display viewfinder and 3D imaging without interference on the touch screen.
- Stored scan data is accessible and can be displayed.

Note: Due to electromagnetic disturbance, in some cases, the image may disappear and a non-communication message will appear on the touch screen. The scanner will return to operation mode after user intervention or auto-recovery.

The following is a summary of the EMC test results for iTero Element 2 Plus scanners:

Test	Standard	Class / Severity level	Test results
Emission (IEC 60601-1-2 / EN 60601-1-2 section 7.1 & 7.2)			
Conducted emission Freq. range: 150 kHz - 30 MHz	CISPR 11 / EN 55011	Group 1 Class B: – AC mains (240 V, 230 V, 120 V, 100 V; 220 V @ 60 Hz)	Complies
Radiated emission Freq. range: 30 - 1000 MHz	CISPR 11 / EN 55011	Group 1 Class B	Complies
Harmonic current emission test	IEC 61000-3-2 / EN 610003-2	AC mains (230 V @ 50 Hz & 220 V @ 60 Hz)	Complies
Voltage changes, Voltage fluctuations and Flicker test	IEC 61000-3-3 / EN 610003-3	AC mains (230 V @ 50 Hz & 220 V @ 50 Hz)	Complies

Immunity (IEC 60601-1-2 / EN 60601-1-2 sections 8.9 and 8.10)

Test	Standard	Class / Severity level	Test results
Immunity from Electrostatic discharge (ESD)	IEC 61000-4-2 / EN 61000-4-2	8 kV contact discharges & 15 kV air discharges (AC mode (230 V @ 50 Hz & 220 V @ 60 Hz) & Battery mode)	Complies
Immunity from radiated electromagnetic fields	IEC 61000-4-3 / EN 61000-4-3	10.0 V/m; 80 MHz ÷ 2.7 GHz, 80% AM, 1 kHz (AC mode ((230 V @ 50 Hz & 220 V @ 60 Hz) & Battery mode)	Complies
Immunity from Proximity field from wireless communications equipment	IEC 61000-4-3 / EN 61000-4-3	List of frequencies, from 9 V/m up to 28 V/m, PM (18 Hz or 217 Hz), FM 1 kHz	Complies
Immunity from Electrical Fast transient (EFT)	IEC 61000-4-4 / EN 61000-4-4	± 2.0 kV on AC mains (230 V @ 50 Hz & 220 V @ 60 Hz); Tr/Th – 5/50 ns, 100 kHz	Complies
Immunity from Surge	IEC 61000-4-5 / EN 61000-4-5	±2.0 CM / ±1.0 kV DM on AC mains (230 V @ 50 Hz & 220 V @ 60 Hz); Tr/Th – 1.2/50 (8/20) µs	Complies
Immunity from conducted disturbances induced by radio-frequency fields	IEC 61000-4-6 / EN 61000-4-6	6.0 VRMS on AC mains (230 V @ 50 Hz & 220 V @ 60 Hz) & Patient cable; 0.15÷ 80 MHz, 80% AM, 1 kHz	Complies
Immunity from power frequency magnetic field	IEC 61000-4-8 / EN 61000-4-8	30 A/m @ 50 Hz & 60 Hz (AC mode and Battery mode)	Complies
Immunity from voltage dips, short interruptions and voltage variations	IEC 61000-4-11 / EN 61000-4-11	On AC mode (240 V @ 50 Hz, 100 V @ 50 Hz): 0 % - 0.5 cycle & 1 cycle; 70% - 25 cycles; 0% - 250 cycles; On AC mode (220 V @ 60 Hz): 0 % - 0.5 cycle & 1 cycle; 70% - 30 cycles; 0% - 300 cycles	Complies
Emission (per ETSI EN 301 489-1, ETSI EN 301 489-17)			
Conducted emissions on mains terminals in freq. range 150 kHz - 30 MHz	ETSI EN 301 489-1; ETSI EN 301 489-17 / EN 55032	Group 1 Class B 230 VAC mains	Complies

Test	Standard	Class / Severity level	Test results
Radiated emissions in freq. range 30 - 6000 MHz	ETSI EN 301 489-1; ETSI EN 301 489-17 / EN 55032	Class B	Complies
Harmonic current test	ETSI EN 301 489-1; ETSI EN 301 489-17 / EN 61000-3-2	230 VAC mains	Complies
Flicker tests	ETSI EN 301 489-1; EN 61000-3-3	230 VAC mains	Complies
Immunity (per ETSI EN 301 489-1, ETSI EN 301 489-17)			
Immunity from Electrostatic discharge (ESD)	EN 61000-4-2	4 kV contact discharge 8 kV air discharge	Complies
Immunity from radiated electromagnetic fields	EN 61000-4-3	3.0 V/m, 80 MHz , 6.0 GHz, 80% AM, 1 kHz	Complies
Immunity from Electrical Fast transient (EFT)	EN 61000-4-4	AC mains: ± 1.0 kV; Tr/Th – 5/50 ns, 5 kHz	Complies
Immunity from Surge	EN 61000-4-5	AC mains: ± 1.0 kV DM / ± 2.0 kV CM, Tr/Th – 1.2/50 (8/20) ms	Complies
Immunity from conducted disturbances induced by radio-frequency fields	EN 61000-4-6	AC mains: 3.0 VRMS; 0.15+80 MHz, 80% AM @ 1 kHz	Complies
Immunity from Voltage interruptions	EN 61000-4-11	AC mains: 0% - 0.5 cycle & 1 cycle; 70% - 25 cycles; 0% - 250 cycles	Complies

C iTerio Element product security whitepaper

This whitepaper applies to the iTerio Element Family of products. Depending on the version of the product you have procured, there may be differences in the features of the product. In addition, as this whitepaper was created at a point-in-time, changes may have occurred in Align Technology's product security practices to address evolution and maturation in the product security ecosystem.

We understand the life sciences and healthcare industry and are addressing security across the organization.

The threat of cyber-attacks to life sciences and healthcare products is constantly evolving. With this in mind, we proactively established a product security program that is focused on minimizing the security risk associated with our products, enabling us to be vigilant when facing emerging threats and to continuously improve our products.

We recognized the importance of incorporating security and privacy considerations by design and throughout our product lifecycle. To accomplish this, we established a cross-functional product security team, including representatives from engineering/software development, security, legal/privacy, information technology, and quality.



We identify security risks using robust risk management processes.

Align Technology is committed to addressing and minimizing security and privacy risks in the products that we design, develop, and maintain. We conduct in-depth assessments of our products so that we can implement appropriate risk mitigation measures at the outset of product development. Based on the risk level of the product, as well as the functionality of the product, the below methodology is applied.

Product Security Risk Management Program: Align Technology conducted the program on the iTerio Element Family of products. The methodology included planning and information gathering, scoping product ecosystem, performing a product security risk assessment, analyzing threats and vulnerabilities, assessing applicable security controls, and calculating the residual risk rating of any identified gaps. Security and privacy risks and controls considered as part of the assessment leverage industry leading practice security risk frameworks including, but not limited to, AAMI TIR57, NIST CSF, IEC/TR 80001-2-2, and the FDA's Content of Premarket Submissions for Management of Cybersecurity in Medical Devices.



Security and privacy features of the product.

We aim to protect your data and patients through the design and maintenance of our products. As a result of our security- and privacy-by-design approach to product development, we have implemented the following non-exhaustive security controls in the iTero Element Family of products.

- **Data-at-rest is encrypted:** The scanners store Personally Identifiable Information (PII) in an encrypted database using AES-256 and intraoral scan images in an encrypted folder using Microsoft Encrypting File System (EFS). These encryption technologies help to prevent an attacker from capturing patient information stored on the scanner.

Applicable to iTero Element, iTero Element 2, iTero Element Flex, iTero Element 5D, and iTero Element 5D Laptop Configuration, iTero Element 2 Plus, iTero Element 5D Plus, iTero Element 5D Plus Lite

- **Data-in-transit is encrypted:** PII and intraoral scan images that are backed up to Align servers is transmitted over transport layer security (TLS) 1.2 encryption using trusted certificates. This helps to prevent an attacker from capturing patient information while in transit.

Applicable to iTero Element, iTero Element 2, iTero Element Flex, iTero Element 5D, and iTero Element 5D Laptop Configuration, iTero Element 2 Plus, iTero Element 5D Plus, iTero Element 5D Plus Lite

- **Anti-malware protections are in place:** The scanners come with pre-installed Trend Micro anti-virus software that checks for malicious files on the system. The anti-virus software definitions are updated frequently and scans are scheduled to run daily on the devices.

Applicable to iTero Element, iTero Element 2, iTero Element 5D, iTero Element 2 Plus, iTero Element 5D Plus, iTero Element 5D Plus Lite

- **Remote maintenance is not possible without permission:** The devices use TeamViewer for establishing a remote session. The TeamViewer software requires a User ID and password that must be supplied from the customer to the Align service personnel before the connection can take place.

Applicable to iTero Element, iTero Element 2, iTero Element Flex, iTero Element 5D, and iTero Element 5D Laptop Configuration, iTero Element 2 Plus, iTero Element 5D Plus, iTero Element 5D Plus Lite

- **Changes to the operating system and software are restricted:** The scanners implement a kiosk mode that prevents the user from making any unwanted changes to the operating system and software components.

Applicable to iTero Element, iTero Element 2, iTero Element 5D, iTero Element 2 Plus, iTero Element 5D Plus, iTero Element 5D Plus Lite

- **User access management controls are enforced:** A user account and password is required to utilize the scanners. This helps protect access to the scanner and protects against unauthorized use.

Applicable to iTero Element, iTero Element 2, iTero Element Flex, iTero Element 5D, and iTero Element 5D Laptop Configuration, iTero Element 2 Plus, iTero Element 5D Plus, iTero Element 5D Plus Lite

- **Segregation of duties is applied:** The scanners offer the ability to register multiple user accounts with different roles to one scanner. There are roles for Doctor, Assistant, and Support Technician. This helps ensure the ability to track activities performed by individual users better protecting the device.

Applicable to iTero Element, iTero Element 2, iTero Element Flex, iTero Element 5D, and iTero Element 5D Laptop Configuration, iTero Element 2 Plus, iTero Element 5D Plus, iTero Element 5D Plus Lite

Security and privacy responsibilities of the customer.

As part of our assessments, we have identified risks that are dependent on how the product is used. The securing of the products we provide to our customers is a shared responsibility among all stakeholders. Based on the assessment conducted on the iTero[®] Element[™] optical impression system series, we expect that you will take the following security steps to protect the product:

- **Physically secure the product and its operating environment:** It is the customer's responsibility to protect the physical security of the product and operate it in a secure manner. For the iTero[®] Element[™] Flex system, control and monitor physical access to the platform hosting the application through the use of mechanisms such as security cameras and security badges. In addition, shut down physical ports of network equipment that is not in use to prevent unauthorized access to the application.

Applicable to iTero Element, iTero Element 2, iTero Element Flex, iTero Element 5D, and iTero Element 5D Laptop Configuration, iTero Element 2 Plus, iTero Element 5D Plus, iTero Element 5D Plus Lite

- **Securely operate and protect your network:** It is the customer's responsibility to secure your network through the use of network intrusion detection and prevention mechanisms, using adequately hardened network/application firewalls, and network segmentation, especially if exposed to public Internet. Additionally, dispose of data in an appropriate manner, complying with all local laws and regulations.

Applicable to iTero Element, iTero Element 2, iTero Element Flex, iTero Element 5D, and iTero Element 5D Laptop Configuration, iTero Element 2 Plus, iTero Element 5D Plus, iTero Element 5D Plus Lite

- **Detect malicious and mobile code:** It is the customer's responsibility to select and implement anti-virus/anti-malware protection for the iTero[®] Element[™] Flex host machine. Additional CPU and memory resources should be provided, if necessary, in order to prevent any degradation in performance caused by the execution of this software.

Applicable to iTero Element Flex and iTero Element 5D Laptop Configuration

- **Create strong passwords and protect login credentials:** It is the customer's responsibility to set strong passwords with to access scanners and Align systems. The more characters it has with special characters, the stronger it is. Using a passphrase without personal information is one of the simplest ways to ensure that you have a strong password along with changing it every 90 days. Protect your username and password login credentials granting you access to scanners and Align systems by not sharing with anyone and working in a secure environment.

Applicable to iTero Element, iTero Element 2, iTero Element Flex, iTero Element 5D, and iTero Element 5D Laptop Configuration, iTero Element 2 Plus, iTero Element 5D Plus, iTero Element 5D Plus Lite

- **Apply segregation of duties and timely remove staff accounts when no longer needed:** If customer has multiple user accounts with access to the scanner, it is the customer's responsibility to register those multiple user accounts with the appropriate role of Doctor, Assistant, or Support Technician. This helps ensure the ability to track activities performed by individual users better protecting the device. Additionally, it is the customer's responsibility to remove user accounts when staff no longer require the access to the scanner.

Applicable to iTero Element, iTero Element 2, iTero Element Flex, iTero Element 5D, and iTero Element 5D Laptop Configuration, iTero Element 2 Plus, iTero Element 5D Plus, iTero Element 5D Plus Lite

- **Ensure current data backup and maintain latest software version:** It is the customer's responsibility to ensure scanners remain connected to Align systems to backup PII and intraoral scan images to Align servers and are being restarted as requested to ensure latest scanner updates are being applied.

Applicable to iTero Element, iTero Element 2, iTero Element Flex, iTero Element 5D, and iTero Element 5D Laptop Configuration, iTero Element 2 Plus, iTero Element 5D Plus, iTero Element 5D Plus Lite

- **Exported data not encrypted:** It is the customer's responsibility to protect exported data, such as intraoral images, by using mechanisms such as digital signatures or encrypting removable media.

Applicable to iTero Element Flex and iTero Element 5D Laptop Configuration

If you have any questions or concerns about the risks as they are described, please do not hesitate to contact TRM@aligntech.com or privacy@aligntech.com.

D System specifications

This section includes the specifications for the following systems:

- [iTero Element 2 system specifications](#)
- [iTero Element Flex system specifications](#)
- [iTero Element 2 Plus system specifications](#)

D.1 iTerio Element 2 system specifications

Monitor	21.5" Full HD (1920x1080) touch screen	
Wand	<ul style="list-style-type: none"> • The wand emits red laser light (680nm Class 1) as well as white LED emissions. • Wand operating power: 15VDC 	
Wireless LAN	A LAN card provides local network communications with wireless connectivity	
Security	See iTerio Element product security whitepaper .	
Operating Power	100-240 VAC- 50/60 Hz- 200 VA (max)	
Operating Temperature	18°C to 26°C / 64.4°F to 78.8°F	
Storage/Transportation Temperature	-5°C to 50°C / 23°F to 122°F	
Operating Pressure and Altitude	Pressure: 520 mmHg to 771 mmHg (-69 kPa to -103 kPa) Altitude: -400 feet to 10,000 feet	
Storage/Transportation Pressure and Altitude	Pressure: 430 mmHg to 760 mmHg (~57 kPa to ~101 kPa) Altitude: 0 feet to 15,000 feet	
Relative Humidity	Operating: 40% to 70% Storage: 30% to 90%	
Dimensions	iTerio Full HD touch-screen computing unit: <ul style="list-style-type: none"> • Height: 356 mm (~14 in) • Width: 552 mm (~21.7 in) • Depth: 65 mm (~2.5 in) Wand: <ul style="list-style-type: none"> • Length: 338.5 mm (~13 in) • Width: 53.5 mm (~2 in) • Depth: 69.8 mm (~3 in) 	Wheel stand: <ul style="list-style-type: none"> • Height: 1280 mm (~50 in) • Width: 645 mm (~25 in) • Depth: 625 mm (~24.5 in)
Net Weight	Monitor: 8.3 kg (~18.3 lbs.) Wand: 0.47 kg (~1.0 lbs.) without the cable Wheel stand: ~13.6 kg (~30 lbs.)	

D.2 iTero Element Flex system specifications

Monitor	Laptop screen								
Wand	<ul style="list-style-type: none"> The wand emits red laser light (680nm Class 1) as well as white LED emissions. Wand operating power: 15VDC 								
Security	Align Technology takes the responsibility of securing the data of our customers and their patients very seriously. All patient data is transmitted via an encrypted TLS channel, and communications and information are securely stored, enabling our customers to take reasonable measures to protect their patient data.								
Operating power	100-240VAC- 50/60 Hz-40VA (max)								
Operating temperature	18°C to 26°C / 64.4°F to 78.8°F								
Storage/Transportation temperature	-5° to 50°C / 23° to 122°F								
Operating altitude	Altitude: 0 feet to 10,000 feet								
Storage/Transportation altitude	Altitude: 0 feet to 15,000 feet								
Relative humidity	Operating: 40% to 70% Storage: 30% to 90%								
Dimensions	<table> <tr> <td>iTero Element Flex hub:</td> <td>iTero Element Flex cradle:</td> </tr> <tr> <td> <ul style="list-style-type: none"> Length: 206 mm (~8 in) Width: 94 mm (~3.7 in) Depth: 36.5 mm (~1.4 in) </td> <td> <ul style="list-style-type: none"> Length: 262 mm (~10 in) Width: 89 mm (~3.5 in) Depth: 52 mm (~2 in) </td> </tr> <tr> <td>iTero Element wand:</td> <td>Carrying case:</td> </tr> <tr> <td> <ul style="list-style-type: none"> Length: 338.5 (~13 in) Width: 53.5 mm (~2 in) Depth: 69.8 mm (~3 in) </td> <td> <ul style="list-style-type: none"> Height: 326.5 mm (~13 in) Width: 455 mm (~18 in) Depth: 184 mm (~7 in) </td> </tr> </table>	iTero Element Flex hub:	iTero Element Flex cradle:	<ul style="list-style-type: none"> Length: 206 mm (~8 in) Width: 94 mm (~3.7 in) Depth: 36.5 mm (~1.4 in) 	<ul style="list-style-type: none"> Length: 262 mm (~10 in) Width: 89 mm (~3.5 in) Depth: 52 mm (~2 in) 	iTero Element wand:	Carrying case:	<ul style="list-style-type: none"> Length: 338.5 (~13 in) Width: 53.5 mm (~2 in) Depth: 69.8 mm (~3 in) 	<ul style="list-style-type: none"> Height: 326.5 mm (~13 in) Width: 455 mm (~18 in) Depth: 184 mm (~7 in)
iTero Element Flex hub:	iTero Element Flex cradle:								
<ul style="list-style-type: none"> Length: 206 mm (~8 in) Width: 94 mm (~3.7 in) Depth: 36.5 mm (~1.4 in) 	<ul style="list-style-type: none"> Length: 262 mm (~10 in) Width: 89 mm (~3.5 in) Depth: 52 mm (~2 in) 								
iTero Element wand:	Carrying case:								
<ul style="list-style-type: none"> Length: 338.5 (~13 in) Width: 53.5 mm (~2 in) Depth: 69.8 mm (~3 in) 	<ul style="list-style-type: none"> Height: 326.5 mm (~13 in) Width: 455 mm (~18 in) Depth: 184 mm (~7 in) 								
Net weight	<p>iTero Element Flex hub: ~0.5 kg (~1 lbs.)</p> <p>iTero Element Flex wand: 0.47 kg (~1 lbs.)</p> <p>Empty carrying case: ~2 kg (~4.5 lbs.)</p>								
Shipping weight	~8 kg (~17.6 lbs.)								

D.3 iTero Element 2 Plus system specifications

	Cart configuration	Mobile configuration
Monitor	21.5" Full HD (1920x1080) touch screen	15.6" Full HD (1920x1080) touch screen
Wand	<ul style="list-style-type: none"> The wand emits red laser light (680nm Class 1) as well as white LED emissions. Wand operating voltage: 15VDC 	
Wireless LAN	A LAN card provides local network communications with wireless connectivity <ul style="list-style-type: none"> 2.4GHz, 5GHz 802.11ac 	
Security	See iTero Element product security whitepaper .	
	Cart configuration	Mobile configuration
Operating Power	100-240 VAC- 50/60 Hz- 300 VA (max)	100-240 VAC- 50/60 Hz- 250 VA (max)
Operating environmental conditions		
• Temperature	18°C to 26°C / 64.4°F to 78.8°F	
• Relative Humidity	40% to 70% (non condensing)	
• Altitude	-400 feet to 10,000 feet	
Transportation environmental conditions		
• Temperature	-5°C to 50°C / 23°F to 122°F	
• Relative Humidity	30% to 90% (non condensing)	
• Altitude	-400 feet to 15,000 feet	
Storage environmental conditions		
• Temperature	-5°C to 50°C / 23°F to 122°F	
• Relative Humidity	30% to 90% (non condensing)	
• Altitude	-400 feet to 15,000 feet	

Physical properties

<ul style="list-style-type: none"> • Wand 	<ul style="list-style-type: none"> • Length: 338.5 mm (~13 in) • Width: 53.5 mm (~2 in) • Depth: 69.8 mm (~3 in) 	
	<p>Cart configuration</p> <ul style="list-style-type: none"> • Height: 356 mm (~14 in) • Width: 544 mm (~21.5 in) • Depth: 60.5 mm (~2.3 in) 	<p>Mobile configuration</p> <ul style="list-style-type: none"> • Height: 275 mm (~10.8 in) • Width: 419 mm (~16.5 in) • Depth: 41.5 mm (~1.6 in)
<ul style="list-style-type: none"> • iTero Full HD touch-screen computing unit 	<p>Cart configuration</p> <ul style="list-style-type: none"> • Height: 1279 mm (~50.3 in) • Width: 544 mm (~21.4 in) • Depth: 562 mm (~22.1 in) 	<p>Mobile configuration</p> <p>N/A</p>
<ul style="list-style-type: none"> • Wheel stand 	<p>Cart configuration</p> <ul style="list-style-type: none"> • Height: 1279 mm (~50.3 in) • Width: 544 mm (~21.4 in) • Depth: 562 mm (~22.1 in) 	<p>Mobile configuration</p> <p>N/A</p>
<ul style="list-style-type: none"> • Cable length 	<p>Wand cable: 1.8 m typical</p> <p>Power cable: 3000 mm</p>	<p>Wand cable: 1.8 m typical</p> <p>Power cable: 1600 mm or 3000 mm</p>
<ul style="list-style-type: none"> • Net Weight 	<p>Cart configuration</p> <p>Computing unit: 10.5 kg (~23.1 lbs.)</p> <p>Wand: 0.47 kg (~1.0 lbs.) without the cable</p> <p>Wheel stand: ~12.5 kg (~27.5 lbs.)</p>	<p>Mobile configuration</p> <p>Computing unit with cradle and wand: ~5.5 kg (~12.0 lbs.)</p> <p>System packed in trolley: ~11 kg (~24.0 lbs.)</p> <p>Wand: 0.47 kg (~1.0 lbs.) without the cable</p>
<p>CPU Specifications</p>	<p>Intel® Core™ i7</p>	
<p>GPU Specifications</p>	<p>Nvidia</p>	
<p>Battery</p>	<p>Integrated battery for uninterrupted scanning and ease in office portability without plugging in or rebooting, providing:</p> <ul style="list-style-type: none"> • At least 30 minutes of active continuous scanning (cart configuration) and 10 minutes (mobile configuration) • <2.5 hours for full recharge 	
<p>Scanner and wand cross-contamination protection</p>	<ul style="list-style-type: none"> • Single-use, disposable sleeves 	

Accessible ports	USB types A and C
Scanning technology	Parallel Confocal technology
Scanning properties	<ul style="list-style-type: none">• No hovering required – scanning can be done at a distance of 0mm• No field calibration needed• Flexible scanning protocol (start anywhere, auto stitching)• Automated heating of the tip to avoid fogging of the lens
Scan time	Full mouth can be completed in as little as 60 seconds.
Cloud storage	Data can be stored and accessed on the web using cloud storage and the MyiTero web portal.

align™

Align Technology, Inc.
410 North Scottsdale Road,
Suite 1300, Tempe,
Arizona 85281
USA

© 2022 Align Technology, Inc. All rights reserved. Align, Invisalign, iTero Element, among others, are trademarks and/or service marks of Align Technology, Inc. or one of its subsidiaries or affiliated companies and may be registered in the U.S. and/or other countries. 218501 Rev. A

